



Digital Projector

User Manual

LU960UST

VI.00



Copyright and disclaimer

Copyright

Copyright 2020 BenQ Corporation. All rights reserved. No part of this publication may be reproduced, transmitted, transcribed, stored in a retrieval system or translated into any language or computer language, in any form or by any means, electronic, mechanical, magnetic, optical, chemical, manual or otherwise, without the prior written permission of BenQ Corporation. All other logos, products, or company names mentioned in this manual may be the registered trademarks or copyrights of their respective companies, and are used for informational purposes only.

Disclaimer

BenQ Corporation makes no representations or warranties, either expressed or implied, with respect to the contents hereof and specifically disclaims any warranties, merchantability or fitness for any particular purpose. Further, BenQ Corporation reserves the right to revise this publication and to make changes from time to time in the contents hereof without obligation of BenQ Corporation to notify any person of such revision or changes.

This user manual aims to provide the most updated and accurate information to customers, and thus all contents may be modified from time to time without prior notice. Please visit <http://www.benq.com> for the latest version of this manual.

Statement regarding hyperlinks and third-party websites

BenQ is not responsible for the content of the websites or of similar resources, which are maintained and controlled by third parties, that may be linked from this product. Providing links to those websites or to similar resources does not mean that BenQ makes any warranty or representation to their content by expression or by implication.

Any third party content or service preinstalled in this product is provided "as is". BenQ does not, by expression or by implication, make any warrant to the content or to the services provided by third parties. BenQ does not warrant or guarantee that the content or services provided by third parties are accurate, effective, most up-to-date, legal, or complete. Under no circumstances shall BenQ be liable for the content or services provided by third parties including their negligence. Services provided by third parties may be terminated temporarily or permanently. BenQ does not warrant or guarantee that the any content or services provided by third parties are in good condition at any time, and is not liable for the termination of the said content and services. In addition, BenQ is not involved in any transactions you conduct in the websites or similar resources maintained by third parties.

You should contact the content or service providers for any questions, concerns, or disputes.

Table of Contents

Copyright and disclaimer	2
Copyright.....	2
Disclaimer.....	2
Statement regarding hyperlinks and third-party websites	2
Important safety instructions.....	6
General safety instruction	6
Notice on laser.....	7
Laser class.....	7
Laser parameters	7
Label instruction	8
Prepare for installation	10
Cooling notice	11
Package contents	13
Standard packing items	13
Introduction.....	14
Projector exterior view.....	14
Front and upper side view	14
Rear view	14
Controls and functions.....	15
Control panel.....	15
Control terminal	16
Remote control.....	17
Installation	21
Evaluate for distance by image size	21
Obtaining a preferred projected image size	21
Projection dimensions.....	21
Connection	23
Before connecting.....	23
Connecting with AV equipment	25
Connecting with computer	25
Connecting with HDBaseT transmitter	26
Connecting with LAN.....	26
Operations.....	27
Switch on/off the projector.....	27
Connecting the power cord.....	27
Power indicator	27
Switch on the projector	28
Switch off the projector	34
Using the menu	35
Main menu.....	35

Display menu	36
Corner Fit menu	38
Digital Image Resizing.....	38
Blanking menu.....	39
Native Resolution	39
3D menu	40
Fast Mode	40
Picture menu	41
Color Temperature Fine Tuning menu	44
3D Color Management menu	45
Source menu	47
System Setup : Basic menu	48
Menu Settings menu.....	49
Operation Settings menu.....	49
System Setup : Advanced menu	51
Audio Settings menu	53
Light Settings menu	54
Security Settings menu	54
Standby Settings menu.....	55
Network Settings menu	56
Information menu	56
Menu structure	58

Maintenance 63

Before maintaining the projector	63
Care of the projector	63
Clean the lens front surface	63
Clean the projector case	63
Filter maintenance	64
Cleaning the filter	64
Replacing the filter.....	65
LED indicator	66
LED Usage	66
System message.....	66
Burn-In Messages.....	67
Lamp Error Messages.....	67
Thermal Error Messages	67

Troubleshooting 69

Troubleshooting	69
The projector does not turn on.....	69
No picture.....	69
Blurred image.....	69
Remote control does not work.....	69
The password is incorrect.....	69

Specifications..... 70

Specifications	70
Dimensions	71
Attaching for ceiling mount	71

Appendix..... 72

Timing table	72
Support video timing for HDMI input.....	72
Support PC timing for HDMI input.....	72
Support PC timing for PC input.....	75
True 3D Video Compatibility table	77
Support HDMI-1 / HDMI-2 timing for HDBaseT input (Rexton 4K timing).....	77
RS232 command control	78
PJLink	86
PJLink protocol	86
Control commands.....	86

Important safety instructions

Your projector is designed and tested to meet the latest standards for safety of information technology equipment. However, to ensure safe use of this product, it is important that you follow the instructions mentioned in this manual and marked on the product.

General safety instruction

1. Do not look straight at the projector lens during operation. The intense light beam may damage your eyes.
2. Always open the lens shutter or remove the lens cap when the projector light source is on.
3. In some countries, the line voltage is NOT stable. This projector is designed to operate safely within a mains voltage between 100 to 240 volts AC, but could fail if power cuts or surges of ± 10 volts occur. In areas where the mains voltage may fluctuate or cut out, it is recommended that you connect your projector through a power stabilizer, surge protector or uninterruptible power supply (UPS).
4. Do not block the projection lens with any objects when the projector is under operation as this could cause the objects to become heated and deformed or even cause a fire. To temporarily turn off the light source, press **BLANK** on the remote control.
5. Do not place this product on an unstable cart, stand, or table. The product may fall, sustaining serious damage.
6. Do not attempt to disassemble this projector. There are dangerous high voltages inside which may cause death if you should come into contact with live parts.
Under no circumstances should you ever undo or remove any other covers. Refer servicing only to suitably qualified professional service personnel.
7. Do not place this projector in any of the following environments.
 - Space that is poorly ventilated or confined. Allow at least 50 cm clearance from walls and free flow of air around the projector.
 - Locations where temperatures may become excessively high, such as the inside of a car with all windows rolled up.
 - Locations where excessive humidity, dust, or cigarette smoke may contaminate optical components, shortening the projector's life span and darkening the image.
 - Locations near fire alarms
 - Locations with an ambient temperature above 40°C / 104°F
 - Locations where the altitudes are higher than 3000 m (10000 feet).
8. Do not block the ventilation holes.
 - Do not place this projector on a blanket, bedding or any other soft surface.
 - Do not cover this projector with a cloth or any other item.
 - Do not place inflammables near the projector.

If the ventilation holes are seriously obstructed, overheating inside the projector may result in a fire.

9. Do not step on the projector or place any objects upon it. Besides probable physical damage to the projector, doing so may result in accidents and possible injury.
10. Do not place liquids near or on the projector. Liquids spilled into the projector may cause it to fail. If the projector does become wet, disconnect it from the power supply's wall socket and call BenQ to have the projector serviced.

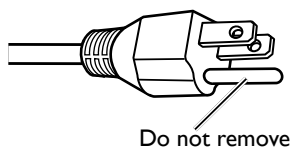

This equipment has a three-pin grounding-type power plug. Do not remove the grounding pin. As a safety feature, this plug will only fit a grounding-type power outlet. If you are unable to fit the plug into the outlet, contact an electrician.

Notice on laser



This symbol indicates that there is a potential hazard of eye exposure to laser radiation unless the instructions are closely followed.

Laser class



(for USA) This Laser Product is designated as Class 3R during all procedures of operation and complies with IEC/EN 60825-1:2007.

(for WW) This Laser Product is designated as Class I during all procedures of operation and complies with IEC/EN 60825-1:2014.

LASER LIGHT - AVOID DIRECT EYE EXPOSURE.



Do not point laser or allow laser light to be directed or reflected toward other people or reflective objects.

Direct or scattered light can be hazardous to eyes and skin.

There is a potential hazard of eye exposure to laser radiation if the included instructions are not followed.

Caution – use of controls or adjustments or performance of procedures other than those specified herein may result in hazardous radiation exposure.

Laser parameters

Wavelength	449nm - 461nm (Blue)
Mode of operation	Pulsed, due to frame rate
Pulse width	1.15ms
Pulse repetition rate	120Hz
Maximum laser energy	0.76mj
Total internal power	>100w
Apparent source size	>10mm, at lens stop
Divergence	>100 mili Radian

Label instruction

Below drawing show the label's location.

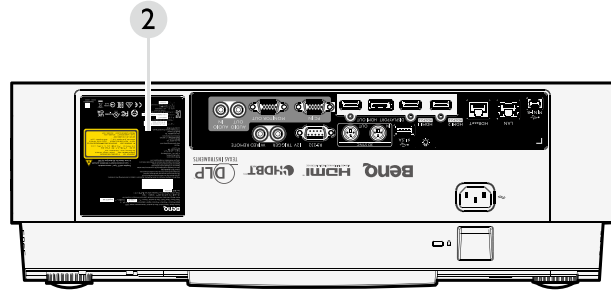
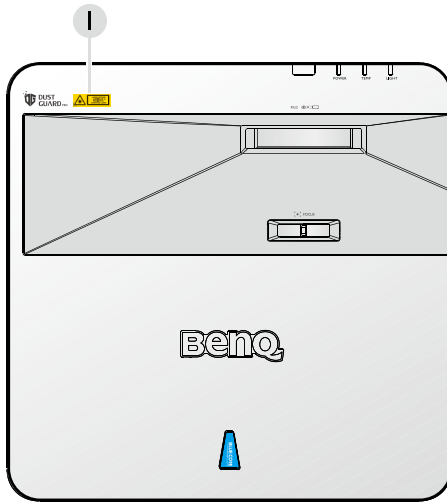

1. Laser warning label



2. Spec label



Interlock switches

This machine has 1 (Top cover x 1) Interlock switches to protect the laser light Leakage. Will power-off the system individually when the top cover is removed.

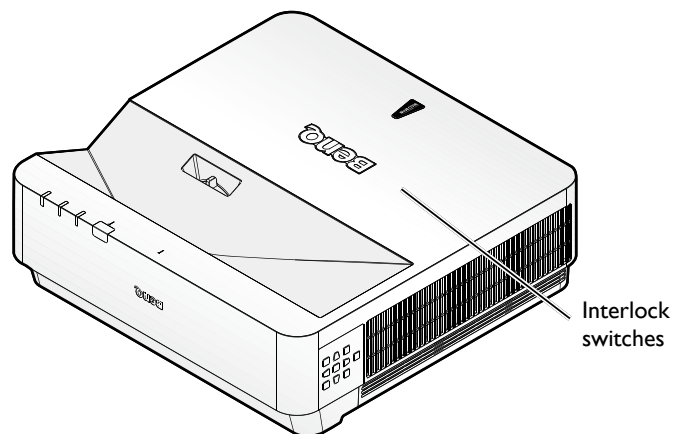

Prepare for installation

Focus adjustment

The high clarity projection lens is thermally affected by the light from the light source; thus, the focus is unstable for a short period immediately after the power is turned on. Please wait at least 15 minutes of continuous projection before adjusting the focus.

Focus adjustment

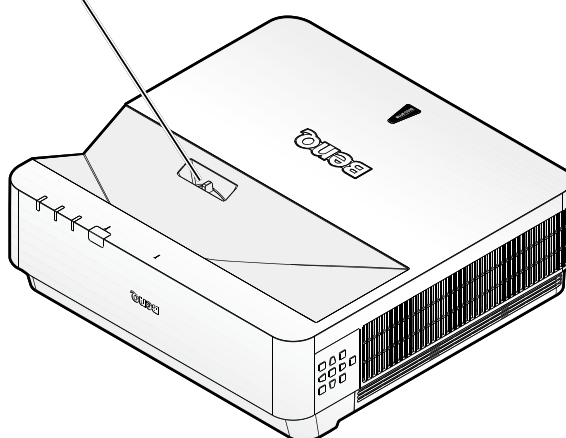

Cooling notice

Allow at least 50 cm (19.7 inch) for clearance around the exhaust vent. Make sure no objects block air inlet within 50 cm (19.7 inch).

Keep the outlet at least 1 m away from the inlets of other projectors.

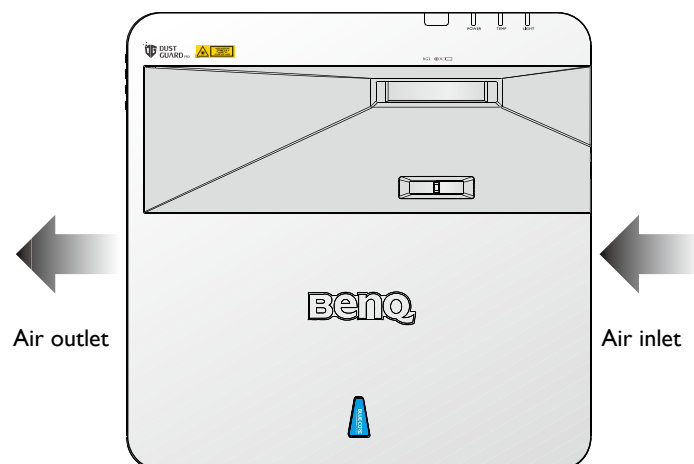

- The projector can be installed at following angles:
360-degree projection

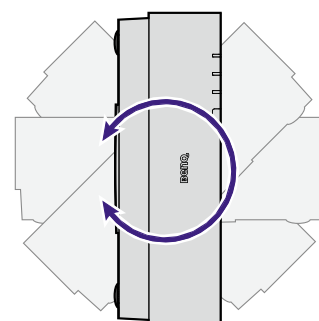
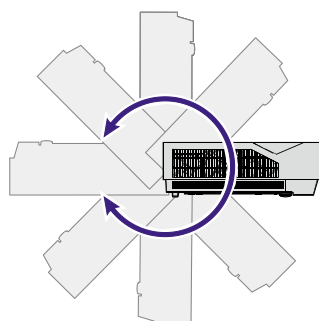

! Caution:

Installation of the projector should be performed carefully. Incomplete or improper installation may cause the projector to fall, resulting in personal injury or property damage.

- Allow at least 50 cm of clearance around the exhaust vent.

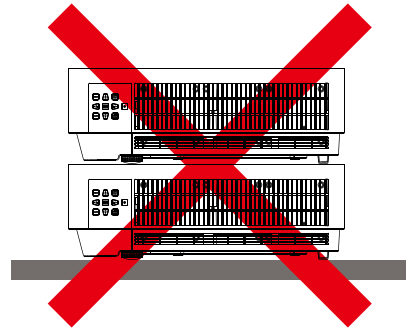
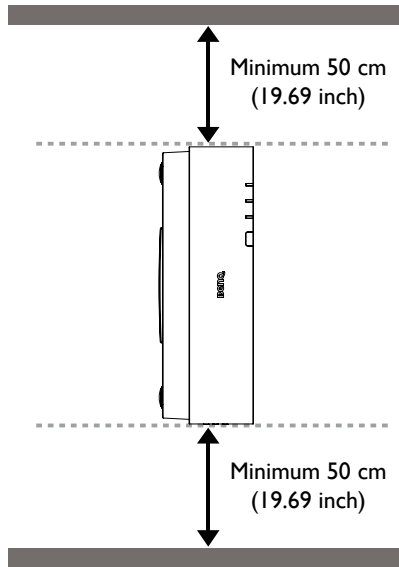
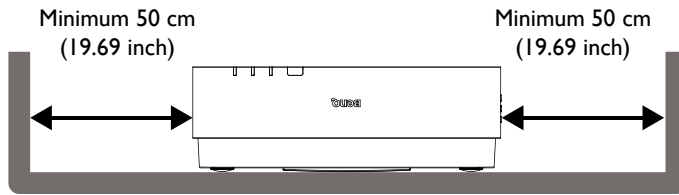

- Ensure that the air intake vents do not recycle hot air from the exhaust vent.
- When operating in an enclosed space, make sure that the surrounding air temperature does not exceed the projector's operating temperature and that the air intake and exhaust vents are unobstructed.
- All enclosures should pass a certified thermal evaluation to ensure that the projector does not recycle exhaust air. Recycling exhaust air may cause the projector to shutdown even if the ambient temperature is within the acceptable operating temperature range.

Package contents

Standard packing items

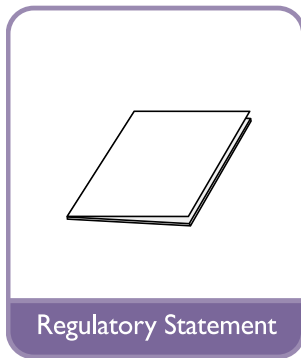
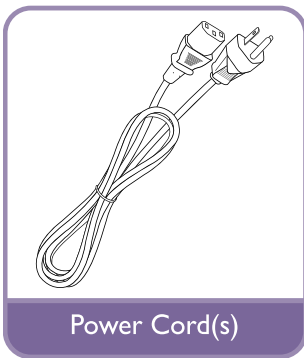
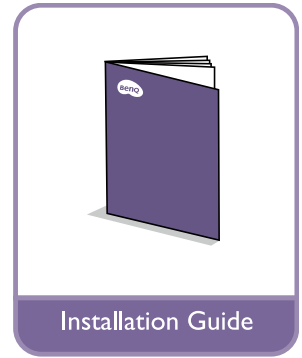
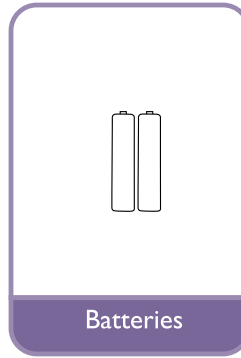
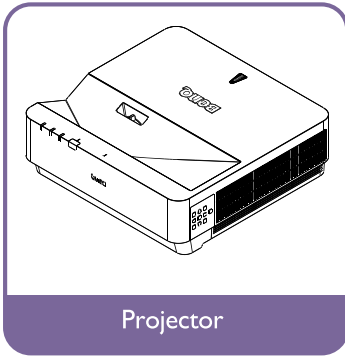

Introduction

Projector exterior view

Front and upper side view

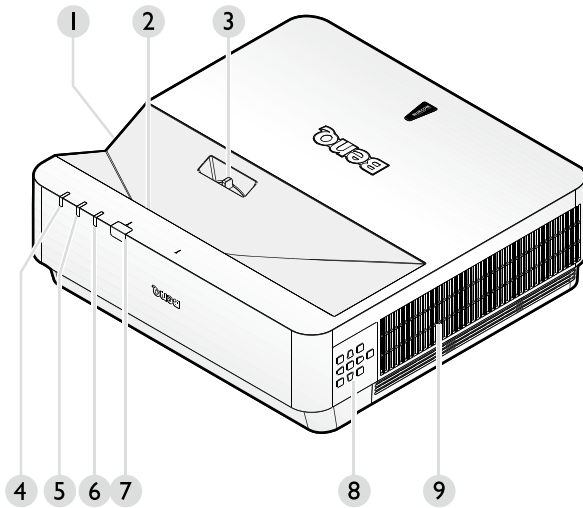

1. Side vent (air inlet)
2. Projection lens
3. Focus adjustment
4. LIGHT SOURCE indicator light
5. TEMPERature indicator light
6. POWER indicator light
7. Front IR remote sensor
8. Control panel
9. Side vent (air outlet)

Rear view

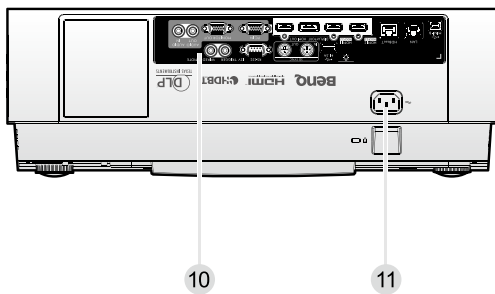







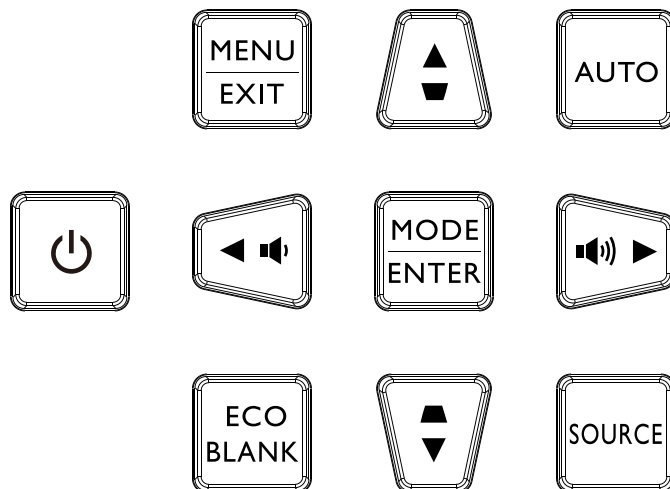

10. Control terminals
11. AC power cord inlet

Controls and functions

Control panel



- **Power**
Toggles the projector between standby mode and on. See ["Switch on the projector" on page 28](#) and ["Switch off the projector" on page 34](#) for details.
- **MENU/EXIT**
Turns on the On-Screen Display (OSD) menu. Goes back to previous OSD menu, exits and saves menu settings. See ["Using the menu" on page 35](#) for details.
- **Volume keys ( , )**
Decreases or increases the projector volume.
- **ECO BLANK**
The automatic switch to Eco Blank Mode after the projector is turned on for over three minutes without a display source.
- **Arrow keys ( ,  ,  , )**
When the On-Screen Display (OSD) menu is activated, these keys are used as directional arrows to select the desired menu items and to make adjustments. See ["Using the menu" on page 35](#) for details.
- **MODE/ENTER**
Selects an available picture setup mode.
Enacts the selected On-Screen Display (OSD) menu item. See ["Using the menu" on page 35](#) for details.
- **Keystone keys ( , )**
Manually corrects distorted images resulting from an angled projection.
- **AUTO**
Automatically determines the best picture timings for the displayed image. See ["Auto adjusting the image" on page 33](#) for details.
- **SOURCE**
Displays the source selection bar.

Control terminal

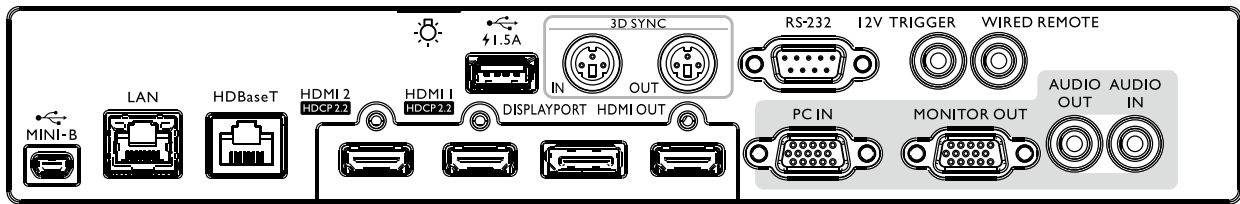

MINI-B

Support Mini USB type B for service only.

LAN

For connection to RJ45 Cat5/Cat6 Ethernet cable to control the projector through a network.

HDBaseT

For connection to a HDBaseT transmitter via an Ethernet cable (Cat5/Cat6) to input up to 4K 30Hz, RS232 control signal and IR control signal. The HDBaseT port supports RS-232/IR/LAN Control, which can be selected in OSD

HDMI 2

Connection to HDMI source.

HDMI 1

Connection to HDMI source.

DISPLAYPORT

Connection to a Display Port source.

HDMI OUT

Connection to HDMI device.

PC IN

15-pin VGA port for connection to RGB, component HD source, or PC.

MONITER OUT

Connection to other display equipment for concurrent playback display.

AUDIO OUT

Connection to a speaker amplifier or headset.

AUDIO IN

Connection to an audio input source via an audio cable.

REAR LIGHT

Illumination for terminals.

USB 1.5A

Support 5V/1.5A output.

3D SYNC IN

Connect 3D-sync in cable from a computer or an enabled device.

3D SYNC OUT

Connection to 3D IR sync signal transmitter.

RS-232 IN

Standard 9-pin D-sub interface for connection to PC control system and projector maintenance.

I2V TRIGGER

3.5mm mini earphone jack, employs 200mA display relay to provide 12(+/-1.5)V output and short circuit protection.

WIRED REMOTE

Connection to wire remote controller.

Caution:

Make sure the port is valid before inserting a wired remote controller. The remote controller may be damaged in case of an invalid port, e.g. a wired remote controller is connected to trigger output. For more information about upgrading firmware via Lan, please contact BenQ service.

Remote control

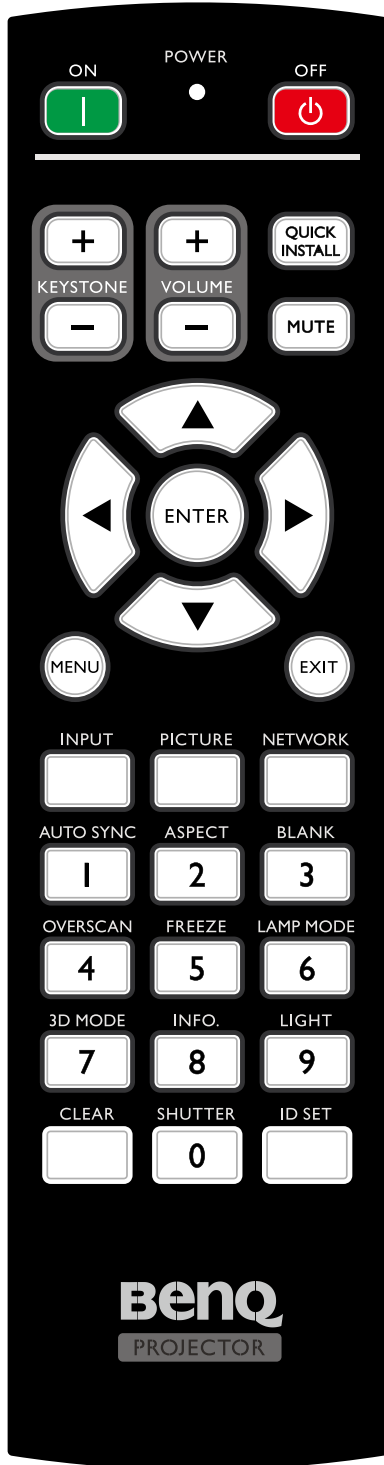

- **ON / OFF**
Toggles the projector between standby mode and on.
- **KEYSTONE+/KEYSTONE-**
Manually corrects distorted images resulting from an angled projection.
- **VOLUME +/VOLUME -**
Increases/decreases the projector volume.
- **QUICK INSTALL**
Displays the **Quick Install** OSD menu.
- **MUTE**
Toggles projector audio between on and off.
- **Arrow keys (▲ Up, ▼ Down, ◀ Left, ▶ Right)**
When the On-Screen Display (OSD) menu is activated, the arrow keys are used as directional arrows to select the desired menu items and to make adjustments. See ["Using the menu" on page 35](#) for details.
- **ENTER**
Selects an available picture setup mode. Activates the selected On-Screen Display (OSD) menu item.
- **MENU**
Turns on the On-Screen Display (OSD) menu. Goes back to previous OSD menu, exits and saves menu settings.
- **EXIT**
Goes back to previous OSD menu, exits and saves menu settings.
- **INPUT**
Selects an input source for display.
- **PCITURE**
Press to display **Picture** menu.
- **NETWORK**
Selects Network Display as the input signal source.
- **AUTO SYNC**
Automatically determines the best picture timings for the displayed image.
- **ASPECT**
Selects the display aspect ratio.
- **BLANK**
Used to hide the screen picture.

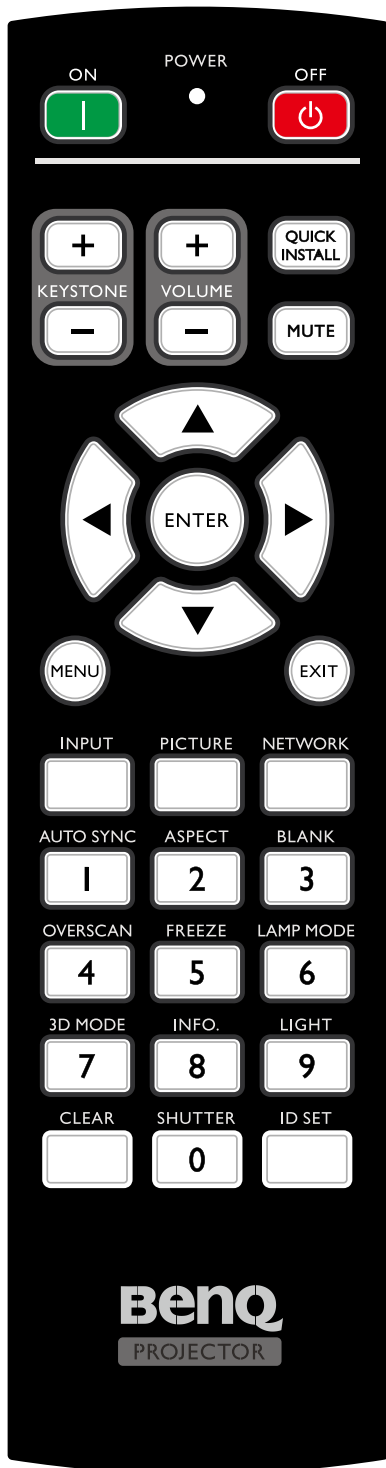

- **OVERSCAN**
Press to select overscan mode.
 - **FREEZE**
Freezes the projected image.
 - **LAMP MODE**
Press to display OSD menu to select desired light mode.
 - **3D MODE**
Press to display 3D setup menu.
 - **INFO.**
Press to display INFORMATION menu.
 - **LIGHT**
Press to open backlight of remote controller.
 - **CLEAR**
Clear remote ID SET assigned to all projectors. Press **CLEAR** and **ID SET** for five seconds. The LED blinks three times then the ID setting is cleared.
 - **SHUTTER**
The function is not available on this projector.
 - **ID SET**
 - Remote control ID SET (set the particular remote code)
Press to set remote ID.
Press **ID SET** for three seconds. The **POWER** indicator on the remote control blinks, then press 01~99 to designate an ID.
-  **Note:**
The remote control number (Remote control ID) must match the Projector ID Setting number for accurate control.
- Clear Remote ID SET (set remote code to all)
Press **CLEAR** and **ID SET** for five seconds. The **POWER** indicator on the remote control blinks a single instance to reset remote code to all, can control projector no matter projector id setting.
 - **Numeric buttons**
Enters numbers in network settings.
Numeric buttons 1, 2, 3, 4 cannot be pressed when asked to enter password.
 - **WIRE REMOTE jack**
Connect to projector for wire remote control.

Connect with projector

When you use a system with multiple projectors, use commercially available M3 stereo mini jack cables to connect the other projectors via the WIRED REMOTE IN/WIRED REMOTE OUT terminals.

The remote control is effective even in places where obstacles stand in the light path or where devices are susceptible to outside light.

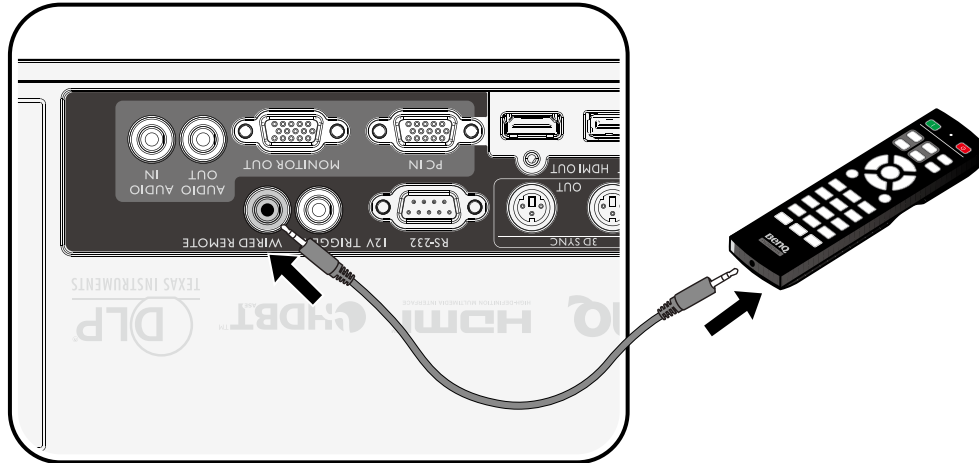

Note:

Use two core shielded cables no longer than 15 m (49.2 ft). The remote control may not operate when the length of the cable exceeds 15 m (49.2 ft) or when it is not properly shielded.

Remote control effective range

Infra-Red (IR) remote control sensor is located on the front and rear of the projector. The remote control must be held at an angle within 30 degrees perpendicular to the projector's IR remote control sensor to function correctly. The distance between the remote control and the sensor should not exceed 8 meters (~ 26 feet).

Make sure that there are no obstacles between the remote control and the IR sensor on the projector that might obstruct the infra-red beam.

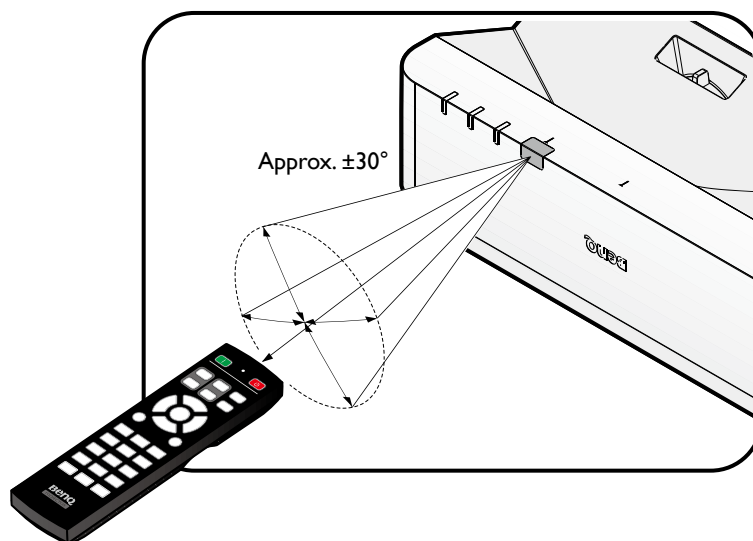

Replacing the remote control battery

1. To open the battery cover, turn the remote control over to view its back, push on the finger grip on the cover and slide it up in the direction of the arrow as illustrated. The cover will slide off.
2. Remove any existing batteries (if necessary) and install two AA batteries observing the battery polarities as indicated in the base of the battery compartment. Positive (+) goes to positive and negative (-) goes to negative.
3. Refit the cover by aligning it with the base and sliding it back down into position. Stop when it clicks into place.

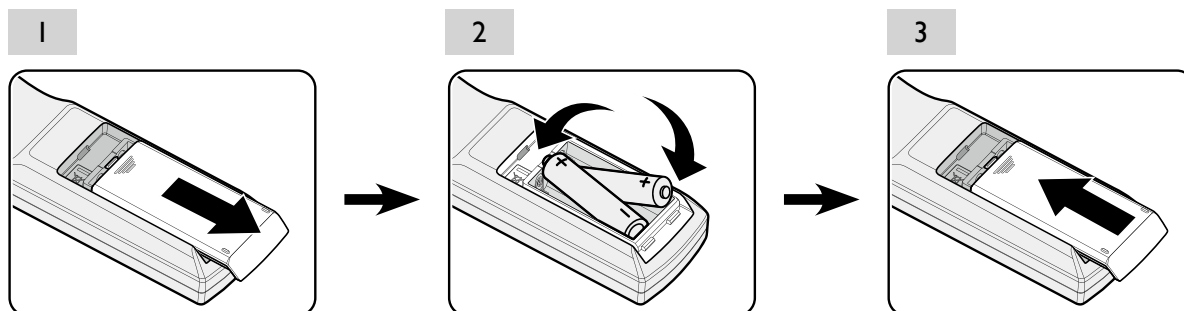

Caution:

- Avoid excessive heat and humidity.
- There may be battery damage if the battery is incorrectly replaced.
- Replace only with the same or equivalent type recommended by the battery manufacturer.
- Dispose of the used battery according to the battery manufacturer's instructions.
- Never throw a battery into a fire. There may be danger of an explosion.
- If the battery is dead or if you will not be using the remote control for a long time, remove the battery to prevent damage to the remote control from possible battery leakage.

Installation

Evaluate for distance by image size

Obtaining a preferred projected image size

The distance from the projector lens to the screen, the zoom setting (if available), and the video format each factors in the projected image size.

Projection dimensions

Refer to "[Dimensions](#)" on [page 69](#) for the center of lens dimensions of this projector before calculating the appropriate position.

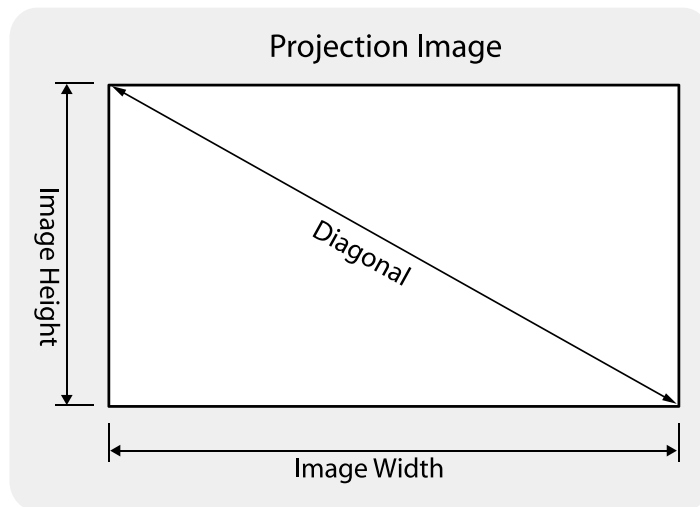

- **LU960UST**

The screen aspect ratio is 16:10 and the projected picture is 16:10.

 **Note:**

To optimize the projection quality, we suggest to project images in an area without grayscale.

Diagonal		Image Width		Image Height		Offset	Fix	Distance (mm)		Distance (mm)	
(Inch)	(mm)	(Inch)	(mm)	(Inch)	(mm)	Projector Top to Screen Bottom (A)		Center of Cover Glass to Screen (B)		Projector Front to Screen (C)	
(Inch)	(mm)	(Inch)	(mm)	(Inch)	(mm)	(Inch)	(mm)	(Inch)	(mm)	(Inch)	(mm)
70	1778	59.4	1508	37.1	943	5.4	136	12.9	328	15.8	402
80	2032	67.8	1723	42.4	1077	6.4	163	15.0	382	17.9	456
87	2210	73.8	1874	46.1	1171	7.2	182	16.5	420	19.4	494
90	2286	76.3	1939	47.7	1212	7.5	190	17.2	436	20.1	510
100	2540	84.8	2154	53.0	1346	8.6	217	19.3	491	22.2	565
120	3048	101.8	2585	63.6	1616	10.7	271	23.6	599	26.5	673
150	3810	127.2	3231	79.5	2019	13.9	352	30.0	762	32.9	836

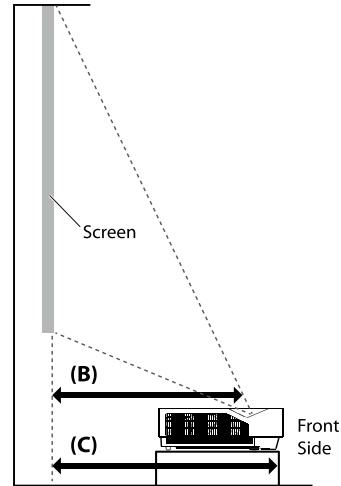
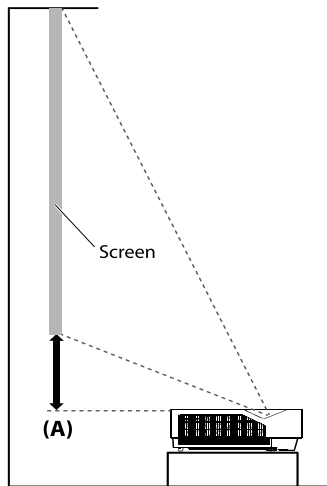

 **Note:**

There is 5% tolerance among these numbers due to optical component variations. BenQ recommends that if you intend to permanently install the projector, you should physically test the projection size and distance using the actual projector before you permanently install it, so as to make allowance for this projector's optical characteristics. This will help you determine the exact mounting position so that it best suits your installation location.

Connection

Before connecting

- Before connecting, carefully read the operating instructions for connecting the external device
- Turn off the power to all devices before connecting cables.
- Take note of the following before connecting cables. Failure to do so may result in malfunctions.
 - Before connecting a cable to the projector or to a device that is connected to the projector, touch any nearby metallic objects to remove any static electricity from your body.
 - Do not use unnecessarily long cables to connect the projector or a device to the projector. Using a longer cable that is wound makes it act like an antenna, making it more susceptible to noise.
 - When connecting cables, connect GND first and then insert the connecting terminal of the connecting device.
- Acquire any connection cables necessary to connect external devices to the system that are not supplied.
- The images on the screen may wobble if the video signal contains too much jitter. In this case, a time base corrector (TBC) must be connected.
- If synchronization signal outputs from computers or video equipment are disrupted due to changes in the video output settings or any other reasons, the colors of projected images may be temporarily disrupted.
- The projector accepts video signals, Y/C signals, YCBCR/YPBPR signals, analog RGB signals (synchronization signals are TTL level), and digital signals.
- Some computer models are not compatible with the projector.
- Use a cable compensator when you connect devices to the projector with long cables. If a cable compensator is not used, the image may not display properly.

PC

No.	Serial
1	R/PR
2	G/Y
3	B/PB
4	N.C.
5	GND
6	GND
7	GND
8	GND

No.	Serial
9	DDC 5V
10	GND
11	N.C.
12	DDC data
13	HSYNC
14	VSYNC
15	DDC clock

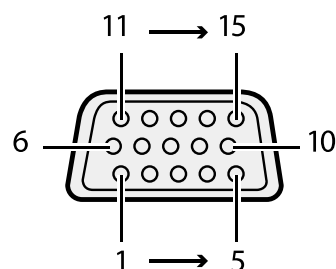

HDMI I

No.	Serial
1	TMDS Data2+
2	TMDS Data2 Shield
3	TMDS Data2-
4	TMDS Data1+
5	TMDS Data1 Shield
6	TMDS Data1-
7	TMDS Data0+
8	TMDS Data0 Shield
9	TMDS Data0-
10	TMDS Clock+

No.	Serial
11	TMDS Clock Shield
12	TMDS Clock-
13	CEC
14	Reserved (N.C. on device)
15	SCL
16	SDA
17	DDC/CEC Ground
18	+5 V Power (max 50 mA)
19	Hot Plug Detect

Even-numbered pins of 2 to 18

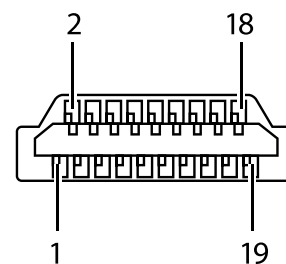

Odd-numbered pins of 1 to 19

Display Port

No.	Serial
1	ML_Lane 0 (p)
2	GND
3	ML_Lane 0 (n)
4	ML_Lane 1 (p)
5	GND
6	ML_Lane 1 (n)
7	ML_Lane 2 (p)
8	GND
9	ML_Lane 2 (n)
10	ML_Lane 3 (p)

No.	Serial
11	GND
12	ML_Lane 3 (n)
13	CONFIG1
14	CONFIG2
15	AUX CH (p)
16	GND
17	AUX CH (n)
18	Hot plug
19	Return
20	DP_PWR

Odd-numbered pins of 1 to 19

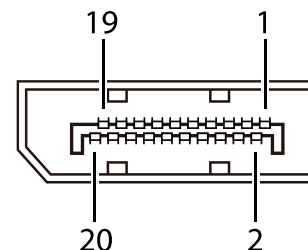

Even-numbered pins of 2 to 20

Connecting with AV equipment

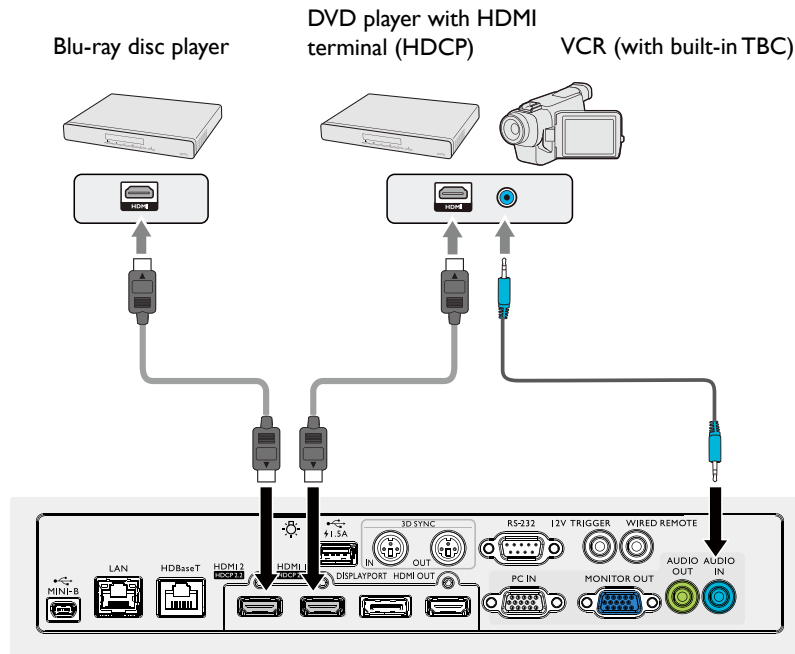

Connecting with computer

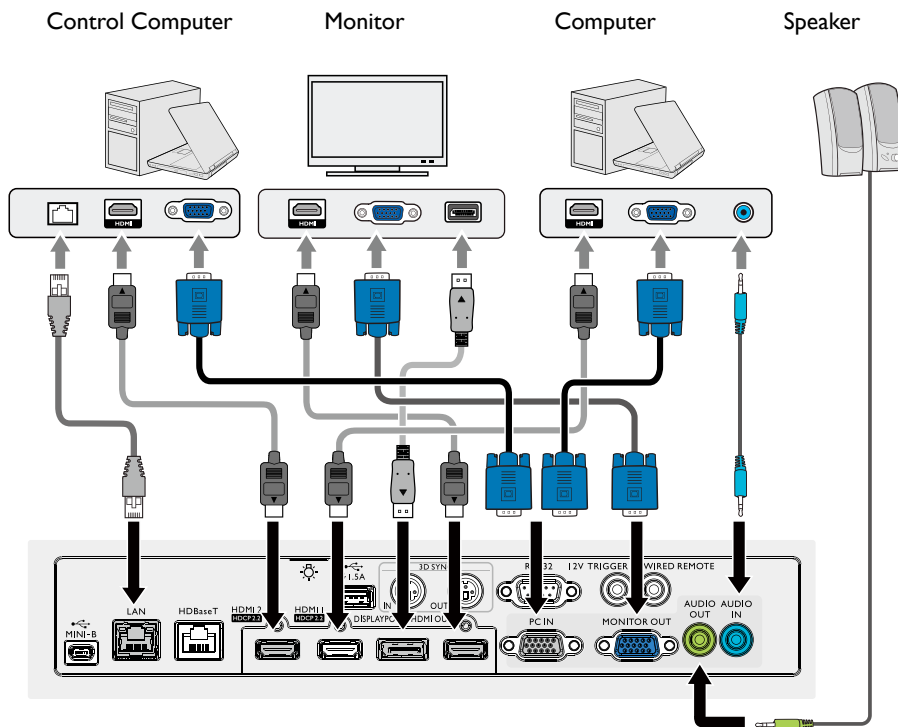

Connecting with HDBaseT transmitter

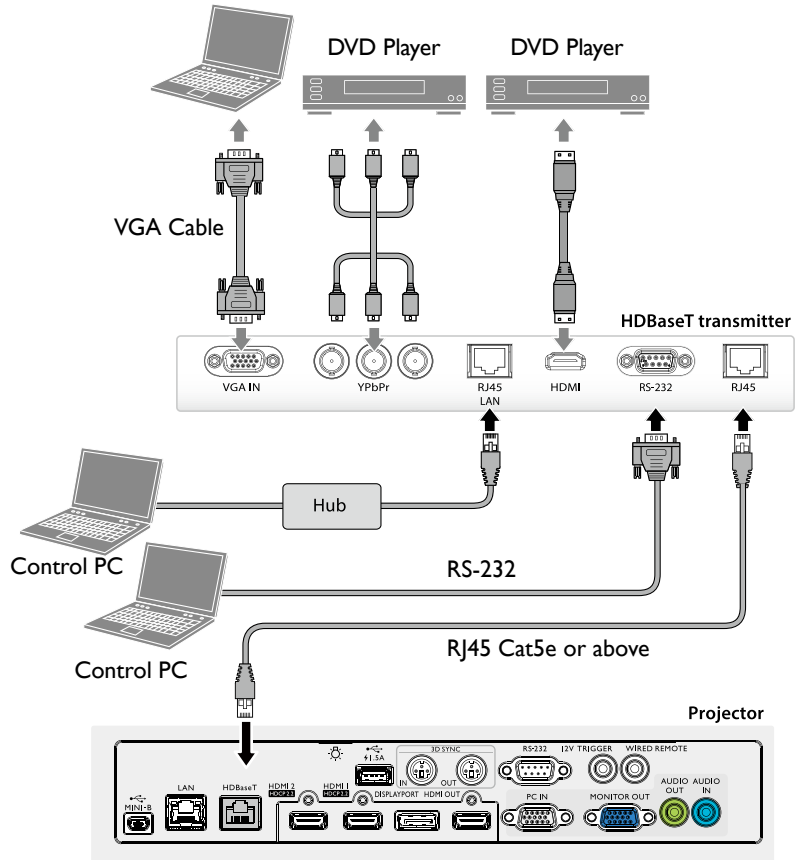

Connecting with LAN

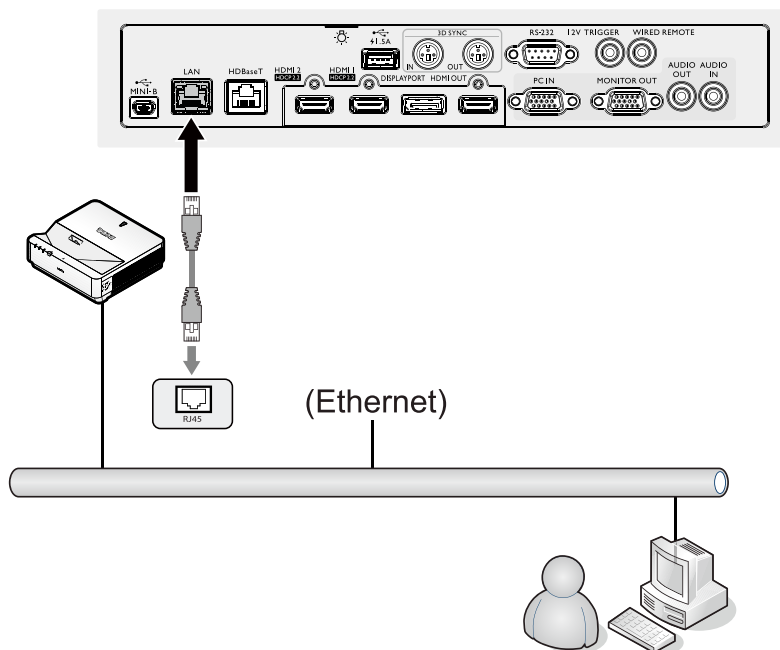

Operations

Switch on/off the projector

Connecting the power cord

Plug the power cord into the projector and into a wall socket. Turn on the wall socket switch (where fitted). Check that the POWER indicator light on the projector lights orange after power has been applied.

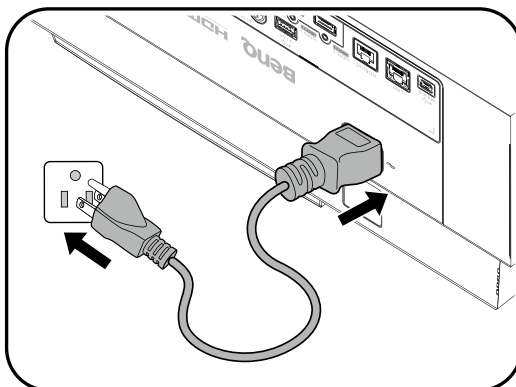

Caution:

Please use the original accessories (e.g. power cable) only with the device to avoid possible dangers such as electric shock and fire.

Power indicator

Power	Temp	Light	Filter	Status & Description
Orange	-	-	-	Stand-by
Green Flashing	-	-	-	Powering up
Green	-	-	-	Normal operation
Orange Flashing	-	-	-	Normal power down cooling

Switch on the projector

Press **POWER** on the projector or **ON** on the remote control to start the projector and a start up tone sounds. The **POWER** indicator light flashes green and stays green when the projector is on.

The start up procedure takes about 30 seconds. In the later stage of start up, a startup logo is projected.

(If necessary) Rotate the focus ring to adjust the image clearness.

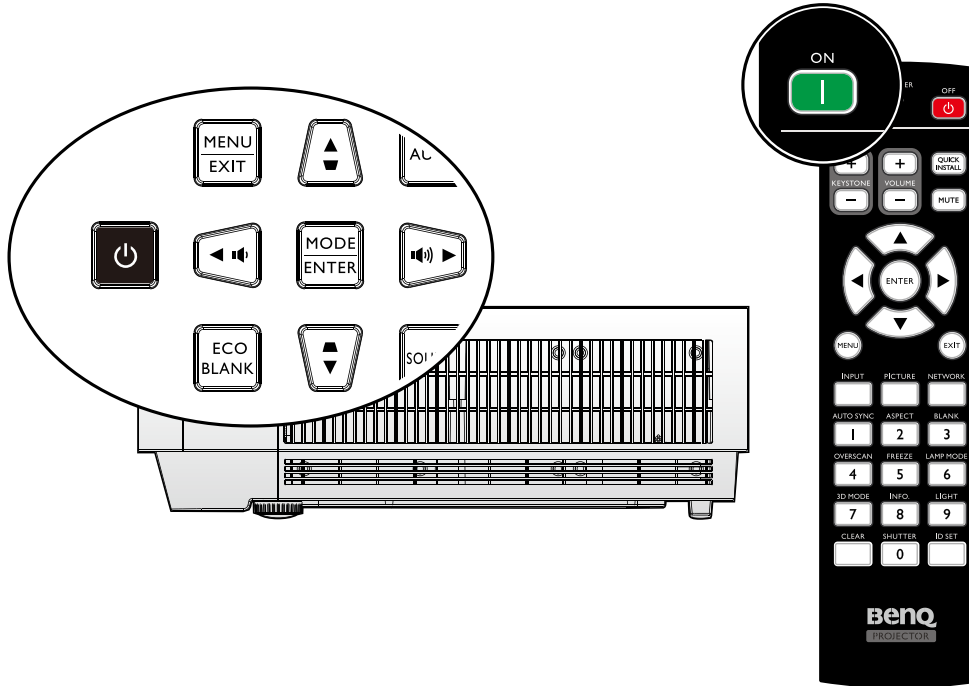

Select language

To use the OSD menus, please set them to your familiar language first.

Please Select Language			
English	한국어	Hrvatski	हिन्दी
Français	Svenska	Română	
Deutsch	Nederlands	Norsk	
Italiano	Türkçe	Dansk	
Español	Čeština	Български	
Русский	Português	suomi	
繁體中文	ไทย	Indonesian	
简体中文	Polski	Ελληνικά	
日本語	Magyar	العربية	
Press Enter to confirm, Exit to leave			

*After this process is done, this menu will not show up again after 1st time adjustment unless user presses **Reset All Settings**.

1. Press **ENTER** on the projector or remote control to turn the OSD menu on.

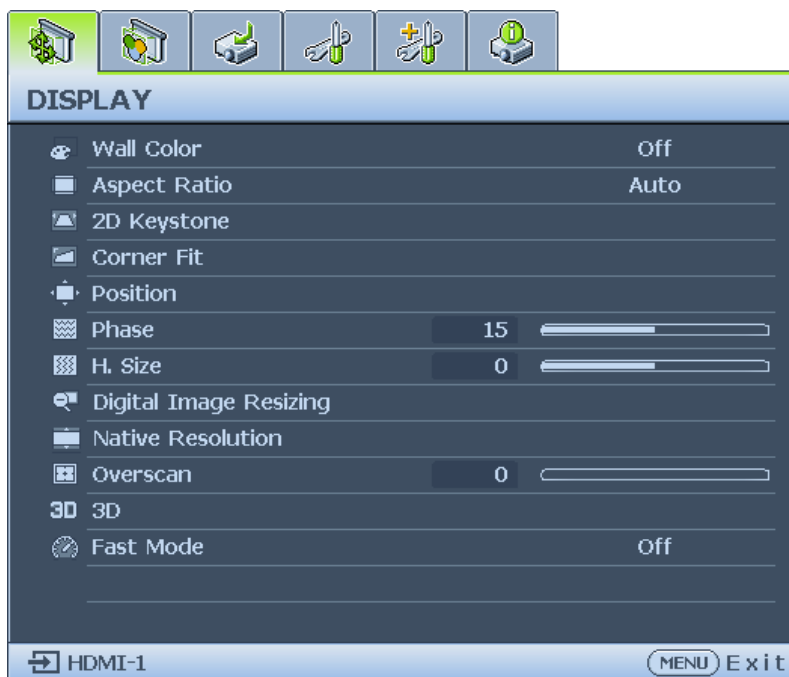

2. Use ◀/▶ to highlight the **System Setup: Basic** menu.

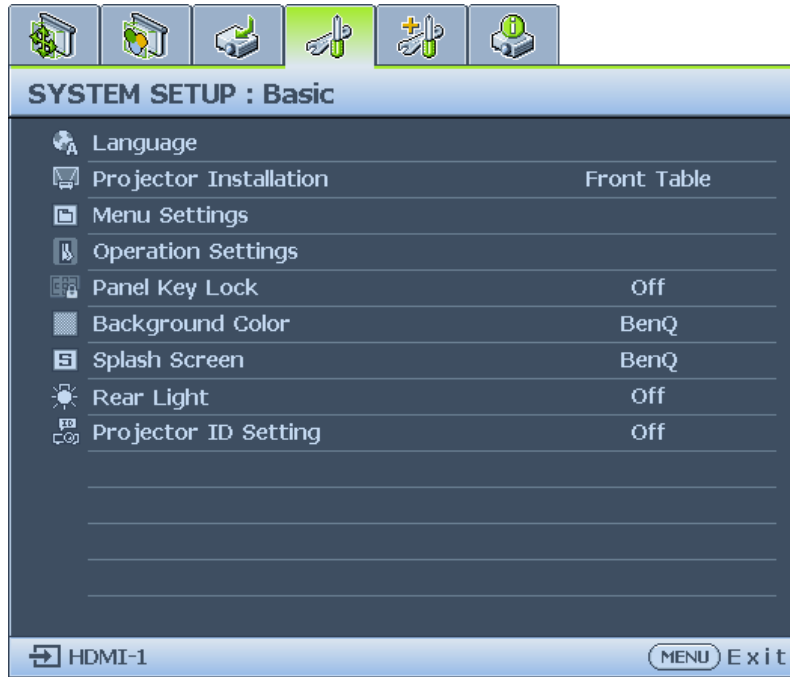

3. Press ▼ to highlight **Language** and press **ENTER** to select a preferred language.



4. Press **ENTER** twice* on the projector or remote control to leave and save the settings.
*The first press leads you back to the main menu and the second press closes the OSD menu.

Using the OSD

Choosing a location

Your projector is designed to be installed in one of four possible installation locations:

1. Front Table

Select this location with the projector placed on a table in front of the screen. This is the most common way to position the projector for quick setup and portability.

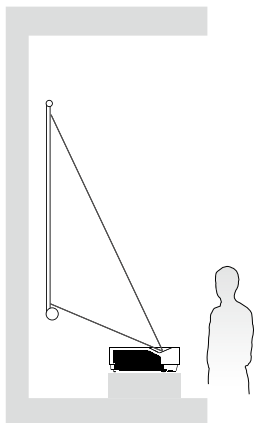

2. Rear Table

Select this location with the projector placed on a table behind the screen. Note that a special rear projection screen is required.

*Set **Rear Table** in the **SYSTEM SETUP: Basic > Projector Installation** menu after you turn the projector on.

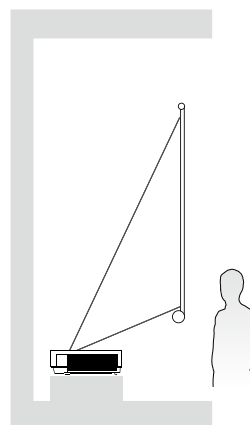

3. Front Ceiling

Select this location with the projector suspended upside-down from the ceiling in front of the screen.

Purchase the BenQ Projector Ceiling Mounting Kit from your dealer to mount your projector on the ceiling.

*Set **Front Ceiling** in the **SYSTEM SETUP: Basic > Projector Installation** menu after you turn the projector on.

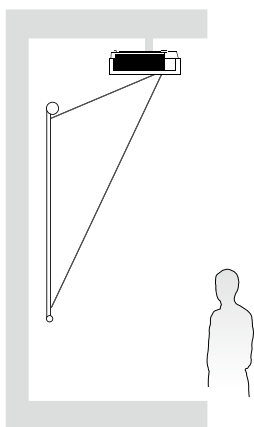

4. Rear Ceiling

Select this location with the projector suspended upside-down from the ceiling behind the screen.

Note that a special rear projection screen and the BenQ Projector Ceiling Mounting Kit are required for this installation location.

*Set **Rear Ceiling** in the **SYSTEM SETUP: Basic > Projector Installation** menu after you turn the projector on.

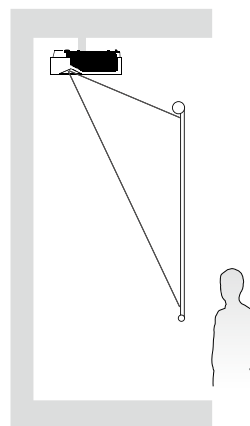

Your room layout or personal preference will dictate which installation location you select. Take into consideration the size and position of your screen, the location of a suitable power outlet, as well as the location and distance between the projector and the rest of your equipment.

Using test pattern

The projector is capable of displaying the grid test pattern. It can be used to assist you with the adjustment of image size and focus, ensuring that the projected image is free from distortion. To display the test pattern, open the OSD menu and go to the **System Setup: Advanced > Test Pattern** and press ◀/▶ to select On.

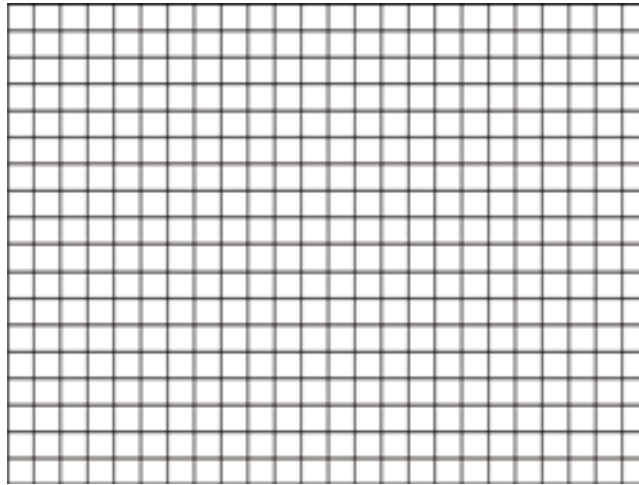

Adjusting by corner fit

Manually adjust four corners of the image by setting the horizontal and vertical values. Using the OSD menu

1. Press **MENU** and then press ◀/▶ until the **Display** menu is highlighted.
2. Press ▼ to highlight **Corner Fit** and press **ENTER**. The **Corner Fit** page displays.

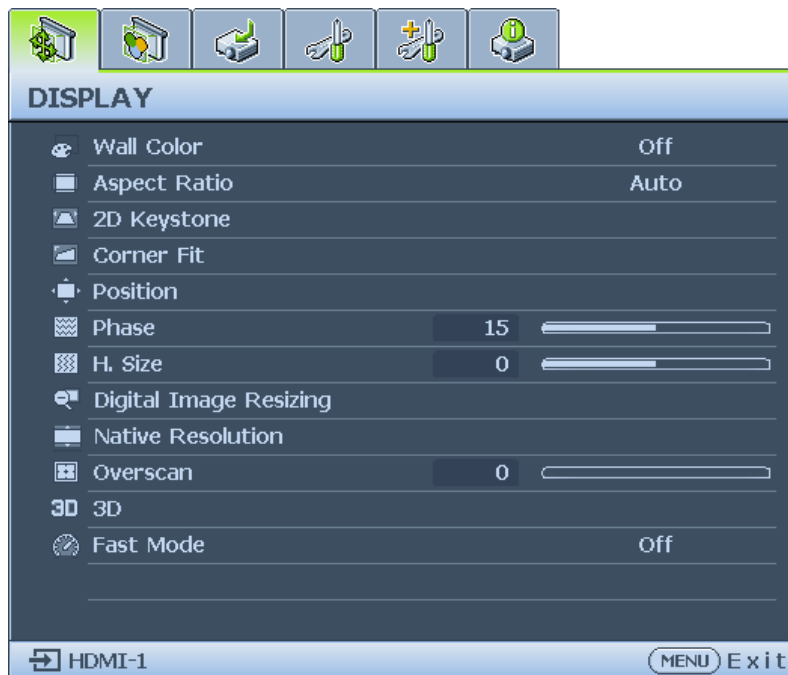

3. Press ▲/▼/◀/▶ to select one of the four corners and press **ENTER**.

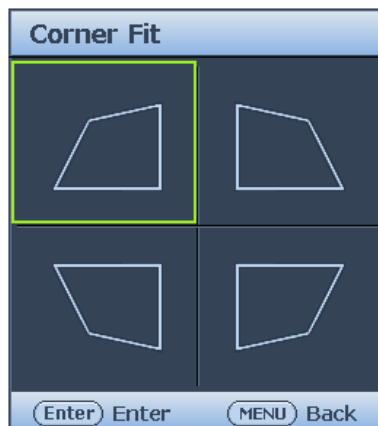

4. Press ▲/▼ to adjust vertical values.

5. Press ◀/▶ to adjust horizontal values.

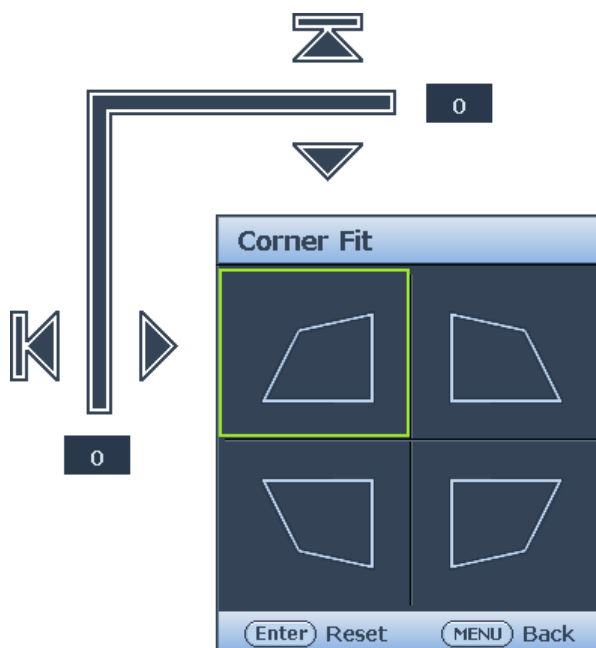

Auto adjusting the image

In some cases, you may need to optimize the picture quality. To do this, press **AUTO** on the projector or remote control. Within 3 seconds, the built-in Intelligent Auto Adjustment function will re-adjust the values of Frequency and Clock to provide the best picture quality.

The current source information will be displayed in the upper left corner of the screen for 3 seconds.

Note:

- The screen will be blank while AUTO is functioning.
- This function is only available when PC signal (analog RGB) is selected.

Fine tuning the image clarity

Sharpen the image by rotating the FOCUS ring.

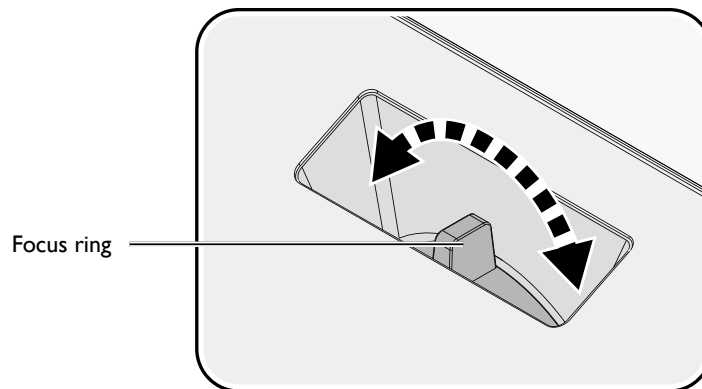

Switch off the projector

1. Press **POWER** or **OFF** and a confirmation message will appear prompting you. If you don't respond in a few seconds, the message will disappear.
2. Press **POWER** or **OFF** a second time. The **POWER** indicator light flashes orange, the projection light source shuts down.

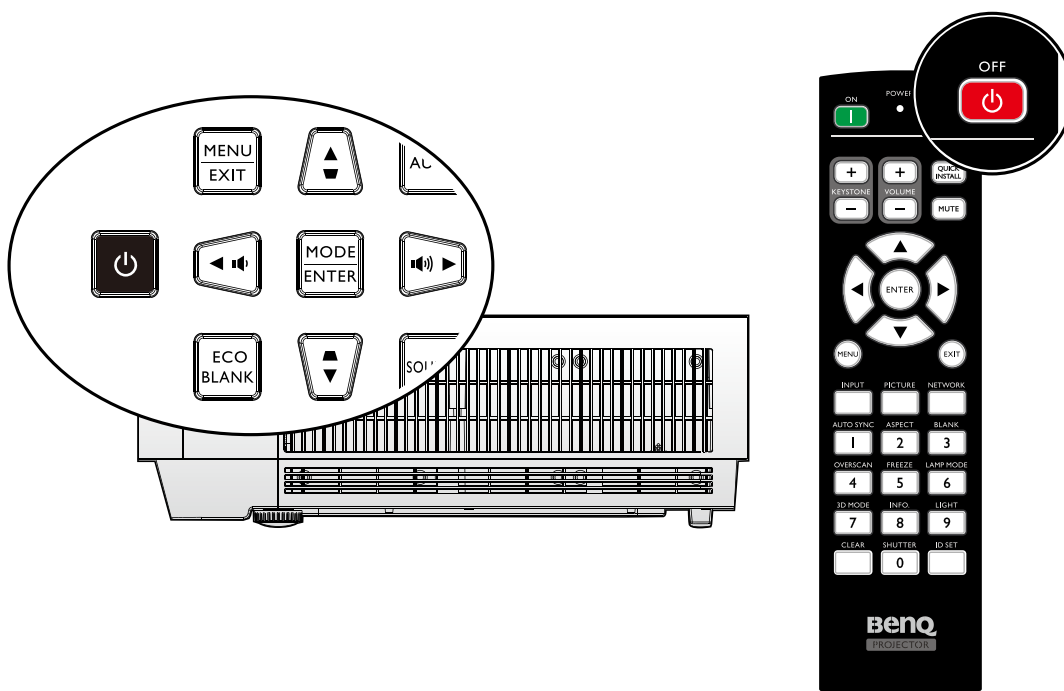

3. Once the cooling process finishes, a "**Power Off Ring Tone**" will be heard. The **POWER** indicator light is a steady orange and fans stop. Disconnect the power cord from the power outlet.

Caution:

- To protect the light source, the projector will not respond to any commands during the cooling process.
- Press **POWER** or **ON** again to start the projector after the **POWER** indicator light turns orange.

Using the menu

Main menu

The projector is equipped with On-Screen Display (OSD) menus for making various adjustments and settings.

Below is the overview of the OSD menu.

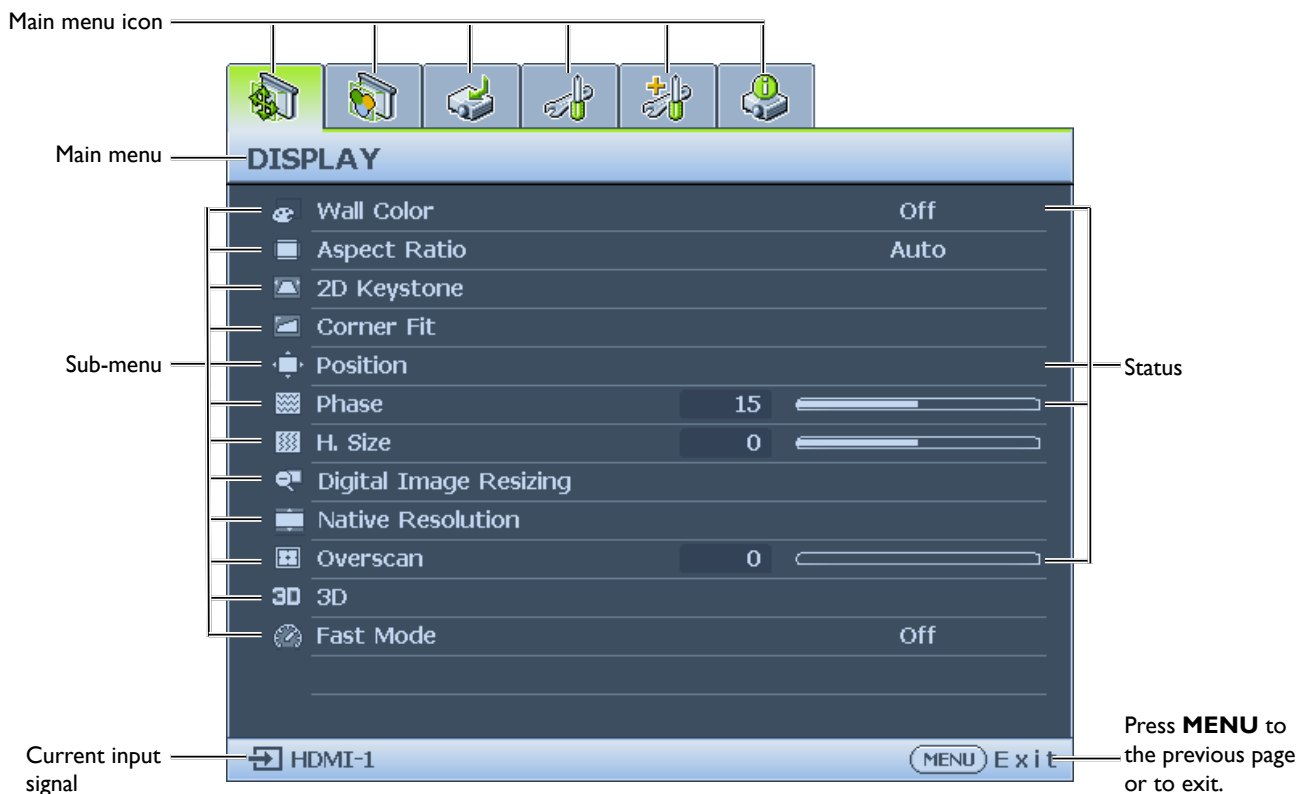

1. Display menu (see "[Display menu](#)" on page 36)
2. Picture menu (see "[Picture menu](#)" on page 41)
3. Source menu (see "[Source menu](#)" on page 45)
4. System Setup : Basic menu (see "[System Setup : Basic menu](#)" on page 47)
5. System Setup : Advanced menu (see "[System Setup : Advanced menu](#)" on page 50)
6. Information menu (see "[Information menu](#)" on page 55)

Available menu items may vary depending on the connected video sources or specified settings. Menu items that are not available will become grayed out.

- Use the arrow keys (▲/▼/◀/▶) on the projector or remote control to move through the menu items.
- Use **ENTER** to confirm the selected menu item.

Display menu

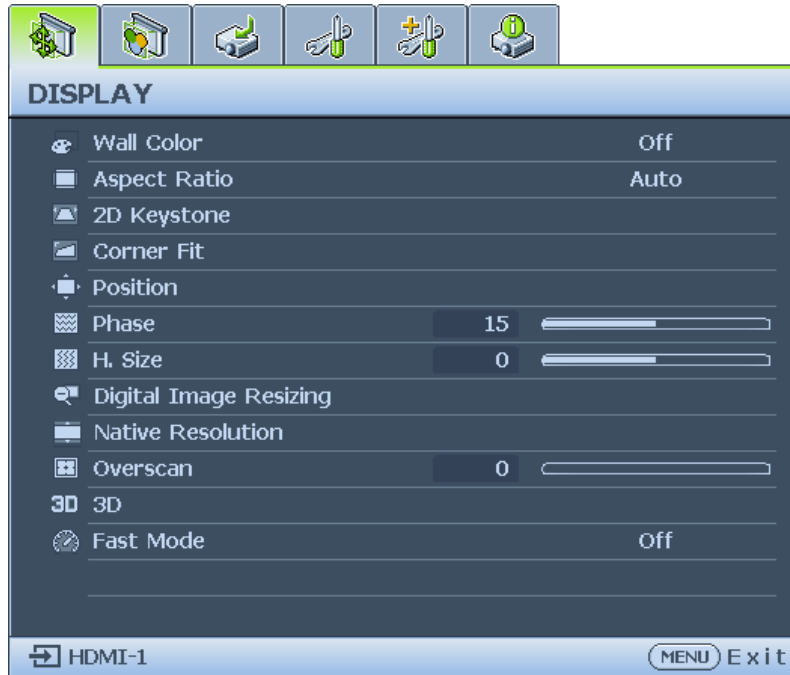

- **Wall Color**

Press ◀/▶ to correct the image color bias reflected by the wall. The options are Off, Light Yellow, Pink, Light Green, Blue and Blackboard.

- **Aspect Ratio**

Press ◀/▶ to adjust the aspect of the projected image. The options are Auto, Real, 4:3, 16:9, 16:10 and 2.4:1.

- Using the remote control

1. Press **ASPECT** to show the current setting.
2. Press **ASPECT** repeatedly to select an aspect ratio to suit the format of the video signal and your display requirements.

1. **Auto:** Scales an image proportionally to fit the projector's native resolution in its horizontal width. This is suitable for the incoming image which is neither in 4:3 nor 16:9 and you want to make most use of the screen without altering the image's aspect ratio.

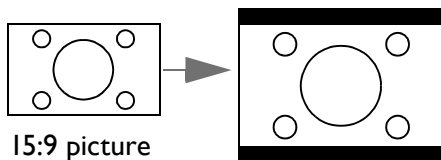

15:9 picture

2. **Real:** The image is projected as its original resolution, and resized to fit within the display area. For input signals with lower resolutions, the projected image will display smaller than if resized to full screen. You could adjust the zoom setting or move the projector away from the screen to increase the image size if necessary. You may also need to refocus the projector after making these adjustments.

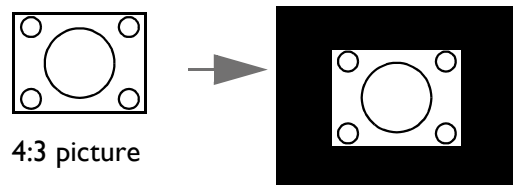

4:3 picture

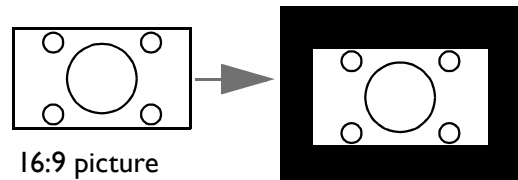

16:9 picture

3. **4:3:** Scales an image so that it is displayed in the center of the screen with a 4:3 aspect ratio. This is most suitable for 4:3 images like computer monitors, standard definition TV and 4:3 images aspect DVD movies, as it displays them without aspect alteration.
4. **16:9:** Scales an image so that it is displayed in the center of the screen with a 16:9 aspect ratio. This is most suitable for images which are already in a 16:9 aspect, like high definition TV, as it displays them without aspect alteration.

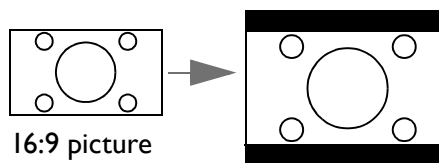
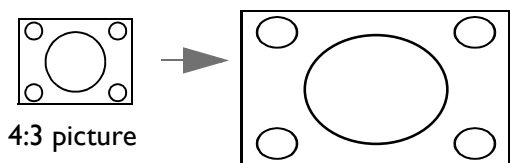

5. **16:10:** Scales an image so that it is displayed in the center of the screen with a 16:10 aspect ratio. This is most suitable for images which are already in a 16:10 aspect, as it displays them without aspect alteration.
6. **2.4:1:** Scales an image so that it is displayed in the center of the screen with a 2.4:1 aspect ratio. This is most suitable for widescreen cinemascope formats for movie theaters or images which already vary to 2.40 aspect, as it displays them without aspect alteration.

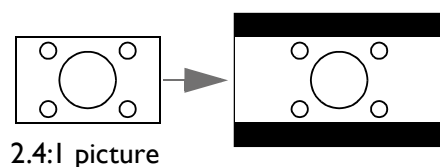
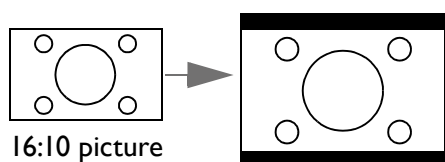

• **2D Keystone**

Press **ENTER** and press **▲/▼/◀/▶** to adjust horizontal or vertical distortion brought by the projection angle.

• **Corner Fit**

Press **ENTER** to enter the **Corner Fit** menu. See "[Corner Fit menu](#)" on page 38 for more details.

• **Position**

Press **ENTER** and press **▲/▼/◀/▶** to adjust the position of the projected picture.

• **Phase**

Press **◀/▶** to adjust Phase for the projected picture.

• **H. Size**

Press **◀/▶** to adjust H. Size for the projected picture.

• **Digital Image Resizing**

Press **ENTER** to enter the **Digital Image Resizing** menu. See "[Digital Image Resizing](#)" on page 38 for more details.

• **Native Resolution**

Press **ENTER** to enter the **Native Resolution** menu. See "[Native Resolution](#)" on page 39.

• **Overscan**

Press **◀/▶** to hide edge of the projected image to damage the noise.

• **3D**

Press **ENTER** to enter the **3D** menu. See "[3D menu](#)" on page 40 for more details.

• **Fast Mode**

Press **◀/▶** to enable or disable **Fast Mode**.

Corner Fit menu

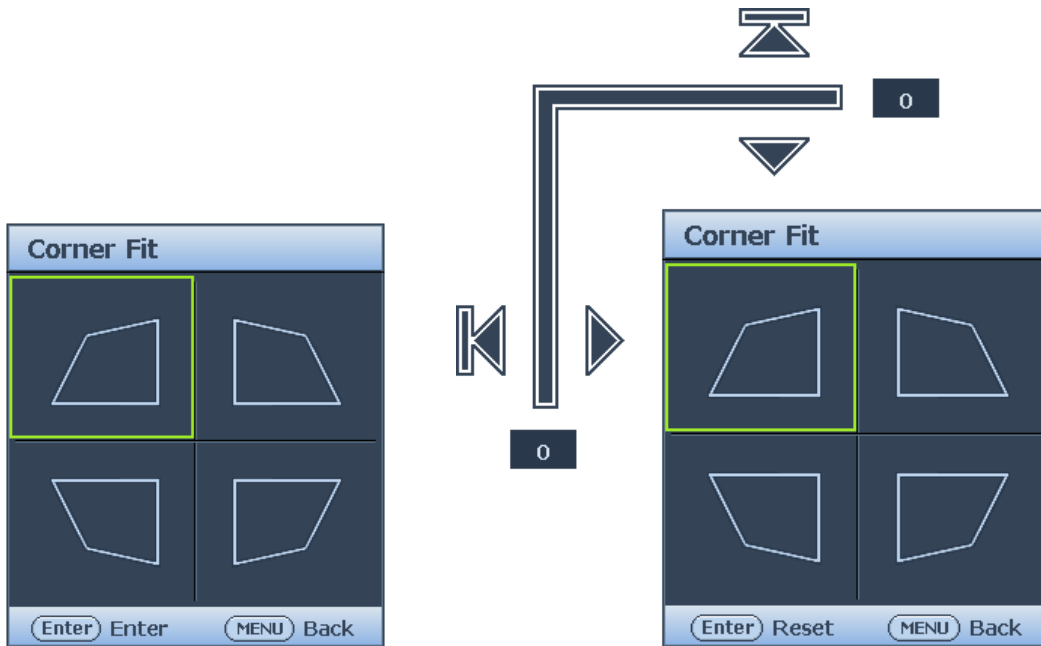

- **Top Left**
Press **ENTER** and press ▲/▼/◀/▶ to correct the top left corner.
- **Top Right**
Press **ENTER** and press ▲/▼/◀/▶ to correct the top right corner.
- **Bottom Left**
Press **ENTER** and press ▲/▼/◀/▶ to correct the bottom left corner.
- **Bottom Right**
Press **ENTER** and press ▲/▼/◀/▶ to correct the bottom right corner.

Digital Image Resizing



- **Digital Zoom**
Press **ENTER** and press ◀/▶ to reduce the image to a desired size. Press **AUTO** to restore the picture to its original size.
- **Digital Shrink**
Press **ENTER** and press ◀/▶ to reduce the image to a desired size. Press **AUTO** to restore the picture to its original size.
- **Digital Image Shift**
Press **ENTER** and press ▲/▼/◀/▶ to shift the image. Press **AUTO** to restore the picture to its original position.
- **Blanking**
Press **ENTER** to enter the **Blanking** menu. See "[Blanking menu](#)" on page 39 for more details.

Blanking menu

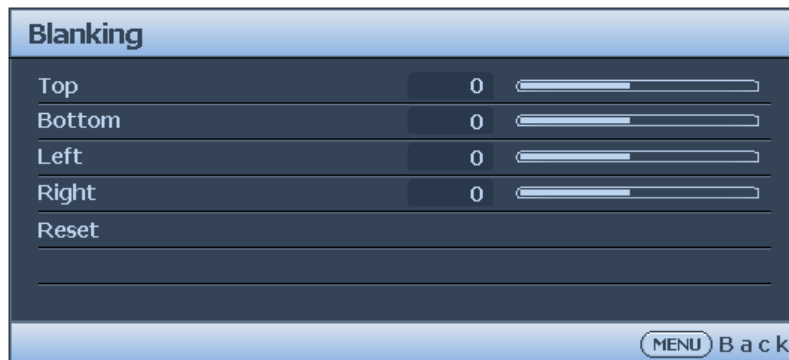

- **Top**
Press ◀/▶ to adjust the top blanking area on the projected picture.
- **Bottom**
Press ◀/▶ to adjust the bottom blanking area on the projected picture.
- **Left**
Press ◀/▶ to adjust the left blanking area on the projected picture.
- **Right**
Press ◀/▶ to adjust the right blanking area on the projected picture.
- **Reset**
Press **ENTER** to set up all Blanking settings to default.

Native Resolution



- **Display Resolution**
Select the native resolution of this projector between **WUXGA** and **1080P**.
- **Digital Lens Shift**
After the **Digital Lens Shift** page displays, press ▲/▼ to shift the projected image.

Note:

This function is not available in the following situations: **Picture Moder** is **3D**; **Native Resolution** is **WUXGA**

3D menu

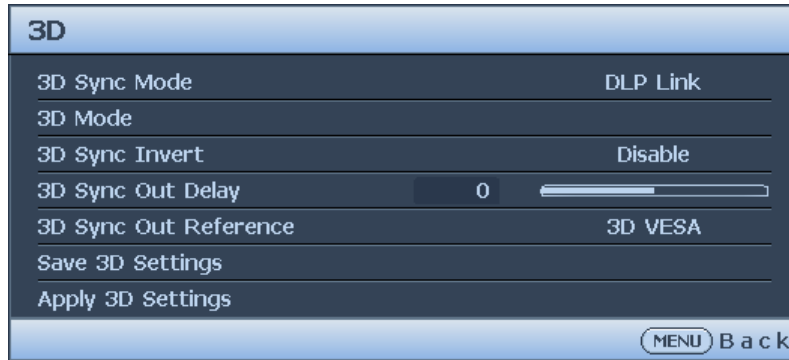

- **3D Sync Mode**
Press ◀/▶ to select the 3D sync mode. The options are DLP Link and VESA 3D.
- **3D Mode**
Press **ENTER** to enter the **3D Mode** menu. Press ▲/▼ to select the 3D format. The options are Auto, Top-Bottom, Frame Sequential, Frame Packing, Side-By-Side and Off.
- **3D Sync Invert**
Press ◀/▶ to enable or disable 3D Sync Invert.
- **3D Sync Out Delay**
Press ◀/▶ to adjust 3D sync out signal delay.
- **3D Sync Out Reference**
Press ◀/▶ to select the 3D sync out behavior. The options are 3D VESA and Bypass to another projector.
- **Save 3D Settings**
Press **ENTER** to enter the **Save 3D Settings** menu. Press ▲/▼ and **ENTER** to save the current 3D settings.
- **Apply 3D Settings**
Press **ENTER** to enter the **Apply 3D Settings** menu. Press ▲/▼ and **ENTER** to apply the saved 3D settings.

Fast Mode

Minimizing the response time (one frame) between the source input and the image output, this mode will enhance the controlling experience.

When using **Fast Mode**:

- In order to have minimized response time, Keystone, Aspect Ratio, 2D Keystone, Corner Fit, Digital Zoom, Digital Shrink, Digital Image Shift, Blanking, Overscan, Display Resolution should be reset to factory preset value.
- Recommend timings are 1920x1200 60Hz. See "[Timing table](#)" on page 70 for more details.

Picture menu



- **Picture Mode**

Press ◀/▶ to select a picture mode. The options are Bright / Presentation / sRGB/Infographic / Video / DICOM SIM / (3D)/(HDMI0) / (HLG) / User 1 / User 2.

- **Bright mode:** Maximizes the brightness of the projected image. This mode is suitable for environments where extra-high brightness is required, such as using the projector in well lit rooms.
- **Presentation mode:** Is designed for presentation. The brightness is emphasized in this mode to match PC and notebook coloring.
- **sRGB mode:** Maximizes the purity of RGB colors to provide true-to-life images regardless of brightness setting. It is most suitable for viewing photos taken with an sRGB compatible and properly calibrated camera, and for viewing PC graphic and drawing applications such as AutoCAD.
- **Infographic:** Is perfect for presentations with the mixture of text and graphics due to its high color brightness and better color gradation to see the details clearly.
- **Video:** Is suitable for playing videos in an environment where there is ambient light. Dynamic color details are preserved by BenQ enhancement technology.
- **DICOM SIM:** This display mode simulates the grayscale/gamma performance of equipment used for “Digital Imaging and Communications in Medicine” (DICOM).
Important: This mode should NEVER be used for medical diagnosis, it is for education/training purposes only.
- **3D mode:** Is appropriate for playing 3D images and 3D video clips. This mode is only available when 3D function is enabled and 3D content is detected.
- **HDMI0 mode:** Only available when detecting HDMI0 content, other picture mode can't be selected
- **HLG mode:** Only available when detecting HLG content, other picture mode can't be selected
- **User 1/User 2 mode:** Recalls the settings customized based on the current available picture modes.

- **Reference Mode**

Press ◀/▶ to select a reference mode. The options are Bright, Presentation, sRGB, Cinema, Vivid and DICOM SIM.



- **Brightness**

Press ◀/▶ to adjust the brightness of the projected image.

The higher the value, the brighter the image. And lower the setting, darker the image. Adjust this control so the black areas of the image appear just as black and that detail in the dark areas is visible.



- **Contrast**

Press ◀/▶ to adjust the contrast of the projected image.

The higher the value, the greater the contrast. Use this to set the peak white level after you have previously adjusted the Brightness setting to suit your selected input and viewing environment.

- **Color**

Press ◀/▶ to adjust the color saturation.

Lower setting produces less saturated colors. If the setting is too high, colors on the image will be overpowering, which makes the image unrealistic.

- **Tint**

Press ◀/▶ to adjust the tint of the projected image.

The higher the value, the more reddish the picture becomes. The lower the value, the more greenish the picture becomes.

- **Sharpness**

Press ◀/▶ to adjust the display sharpness of the projected image.

The higher the value, the sharper the picture becomes. The lower the value, the softer the picture becomes.

- **Brilliant Color**

Press ◀/▶ to adjust the brilliant color of the projected image.

This feature utilizes a new color-processing algorithm and system level enhancements to enable higher brightness while providing truer, more vibrant colors in picture. It enables a greater than 50% brightness increase in mid-tone images, which are common in video and natural scenes, so the projector reproduces images in realistic and true colors. If you prefer images with that quality, select a desired level.

When **0** is selected, the **Color Temperature** function is not available.

- **Gamma Selection**

Gamma refers to the relationship between input source and picture brightness.

- **1.8/2.0/2.1/BenQ/DICOM:** Select these values according to your preference.
- **2.2/2.3:** Increases the average brightness of the picture. Best for a lit environment, meeting room or family room.
- **2.4:** Best for viewing movies in a dark environment.
- **2.6:** Best for viewing movies which are mostly composed of dark scenes.

- **HDR Brightness**

Press ◀/▶ to adjust the HDR brightness.

- **Color Temperature**

Press ◀/▶ to adjust the color temperature. The options are Cool, Normal and Warm.

- **Cool:** makes the image appear bluish white.
- **Normal:** Maintains normal colorings for white.
- **Warm:** Makes images appear reddish white.

- **Color Temperature Fine Tuning**
Press **ENTER** to enter the **Color Temperature Fine Tuning** menu. See "[Color Temperature Fine Tuning menu](#)" on page 43 for more details.
- **3D Color Management**
Press **ENTER** to enter the **3D Color Management** menu. See "[3D Color Management menu](#)" on page 44 for more details.
- **Reset Picture Settings**
Press **ENTER** to enter the **Reset Picture Settings** menu. Press **▲/▼** and press **ENTER** to set to the default value.
 - **Current:** Returns current picture mode to the factory preset settings.
 - **All:** Returns all settings, except User 1/User 2 in the Picture menu to the factory preset settings.

Color Temperature Fine Tuning menu



- **R Gain**
Press **◀/▶** to adjust the Red Gain.
- **G Gain**
Press **◀/▶** to adjust the Green Gain.
- **B Gain**
Press **◀/▶** to adjust the Blue Gain.
- **R Offset**
Press **◀/▶** to adjust the Red Offset.
- **G Offset**
Press **◀/▶** to adjust the Green Offset.
- **B Offset**
Press **◀/▶** to adjust the Blue Offset.

To set a preferred color temperature:

1. Highlight **Color Temperature** and select **Warm, Normal** or **Cool** by pressing **◀/▶** on the projector or remote control.
2. Press **▼** to highlight **Color Temperature Fine Tuning** and press **ENTER**. The Color Temperature Fine Tuning page appears.
3. Press **▲/▼** to highlight the item you want to change and adjust the values by pressing **◀/▶**.
 - **R Gain/G Gain/B Gain:** Adjusts the contrast levels of Red, Green, and Blue.
 - **R Offset/G Offset/B Offset:** Adjusts the brightness levels of Red, Green, and Blue.
4. Press **MENU** to exit and save the settings.

3D Color Management menu

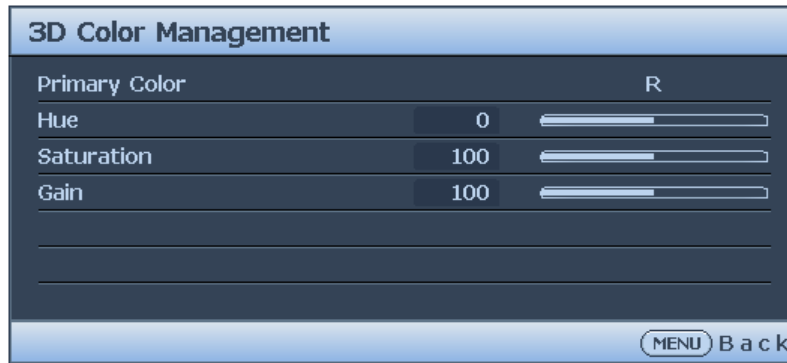

- **Primary Color**
Press **ENTER** to enter the **Primary Color** menu. Press **▲/▼** to select the primary color. The options are R, G, B, C, M, Y, and W.
- When **Primary Color** select R, G, B, C, M and Y, Adjusting Hue, Saturation and Gain.
 - **Hue**
Press **ENTER** to enter the **Hue** menu. Press **▲/▼/◀/▶** to adjust settings.
 - **Saturation**
Press **ENTER** to enter the **Saturation** menu. Press **▲/▼/◀/▶** to adjust settings.
 - **Gain**
Press **ENTER** to enter the **Gain** menu. Press **▲/▼/◀/▶** to adjust settings.
- When **Primary Color** Select White, Adjusting Red Gain/Green Gain/Blue Gain.

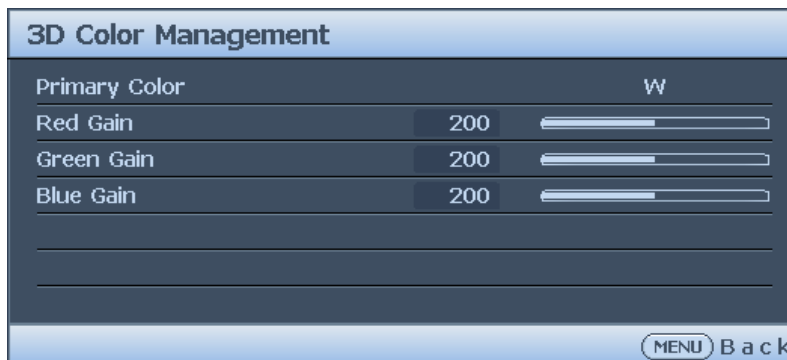

3D Color Management

In most installation situations, color management will not be necessary, such as in classroom, meeting room, or lounge room situations where lights remain on, or where building external windows allow daylight into the room.

Only in permanent installations with controlled lighting levels such as boardrooms, lecture theaters, or home theaters, should color management be considered. Color management provides fine color control adjustment to allow for more accurate color reproduction, should you require it.

Proper color management can only be achieved under controlled and reproducible viewing conditions. You will need to use a colorimeter (color light meter), and provide a set of suitable source images to measure color reproduction. These tools are not provided with the projector, however, your projector supplier should be able to provide you with suitable guidance, or even an experienced professional installer.

The Color Management provides seven sets (RGBCMYW) of colors to be adjusted. When you select each color, you can independently adjust its range and saturation according to your preference.

If you have purchased a test disc which contains various color test patterns and can be used to test the color presentation on monitors, TVs, projectors, etc. You can project any image from the disc on the screen and enter the 3D Color Management menu to make adjustments. To adjust the settings:

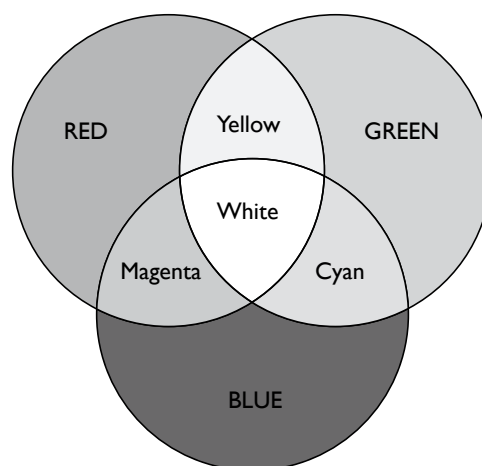

1. Go to the **Picture** menu and highlight **3D Color Management**.
2. Press **ENTER** and the 3D Color Management page displays.
3. Highlight **Primary color** and press **◀/▶** to select a color from among Red, Green, Blue, Cyan, Magenta, Yellow.
4. Press **▼** to highlight **Hue** and press **◀/▶** to select its range. Increase in the range will include colors consisted of more proportions of its two adjacent colors. Please refer to the illustration to the right for how the colors relate to each other. For example, if you select Red and set its range at 0, only pure red in the projected picture will be selected. Increasing its range will include red close to yellow and red close to magenta.
5. Press **▼** to highlight **Saturation** and adjust its values to your preference by press **◀/▶**. Every adjustment made will reflect to the image immediately. For example, if you select Red and set its value at 0, only the saturation of pure red will be affected.
6. Adjusting the **RGB Gain** to get an accurate white point. For example, if you want to correct a reddish white, you can decrease the R gain value. .

Source menu



- **Quick Auto Search**
Press **◀/▶** to enable or disable search the input source automatically.
- **HDR**
Press **◀/▶** to select a suitable HDR setting. The options are Auto, SDR, HDR 10 and HLG.

- **HDMI Format**

Press ◀/▶ to select a suitable color format to optimize display quality. The options are Auto, RGB Limited, RGB Full, YUV Limited and YUV Full.

- **Auto:** Automatically selects a suitable color space and gray level for the incoming HDMI signal.
- **RGB Limited:** Utilizes the Limited range RGB 16-235.
- **RGB Full:** Utilizes the Full range RGB 0-255.
- **YUV Limited:** Utilizes the Limited range YUV 16-235.
- **YUV Full:** Utilizes the Full range YUV 0-255.

- **HDMI EDID**

Press **ENTER** to enter the **HDMI EDID** menu. Press ▲/▼ and press **ENTER** to select the HDMI. Press ◀/▶ to set to the default value.

- **Enhance:** Enhanced mode can switch to HDMI 2.0 EDID.
- **Standard:** Standard mode can switch to HDMI 1.4 EDID.

- **HDMI Equalizer**

Press **ENTER** to enter the **HDMI Equalizer** menu. Press ▲/▼ and press **ENTER** to select the HDMI. Press ◀/▶ to set to the default value.

- **Auto Sync**

Press ◀/▶ to enable or disable auto sync function.

System Setup : Basic menu

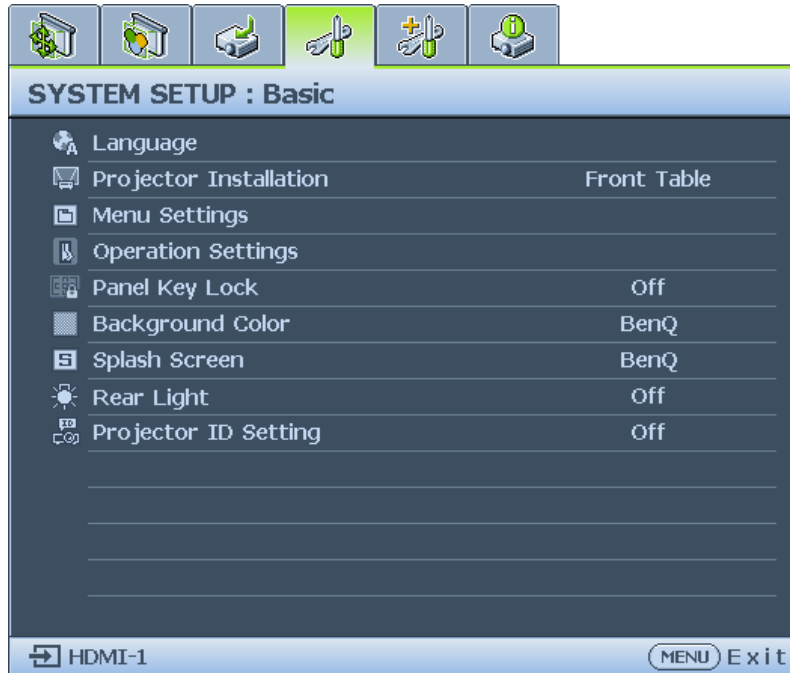

- Language**
 Press **ENTER** to enter the **Language** menu. Press **▲/▼/◀/▶** to select the language of OSD menu.
- Projector Installation**
 Press **◀/▶** to select the projector installation. The options are Front Table, Rear Table, Rear Ceiling and Front Ceiling.
- Menu Settings**
 Press **ENTER** to enter the **Menu Settings** menu. See "[Menu Settings menu](#)" on page 48 for more details.
- Operation Settings**
 Press **ENTER** to enter the **Operation Settings** menu. See "[Operation Settings menu](#)" on page 48 for more details.
- Panel Key Lock**
 Press **◀/▶** to enable or disable all panel key functions except **POWER** on the projector.
- Background Color**
 Press **◀/▶** to select the background color when no input signal. The options are BenQ, Black, Blue and Purple.
- Splash Screen**
 Press **◀/▶** to select the start up pattern when the projector turns on. The options are BenQ, Black and Blue.
- Rear Light**
 To enable or disable Rear LED light for Illumination on terminals.
- Projector ID Setting**
 To use the Left and Right keys to enable or disable the projector ID.

Menu Settings menu



- **Menu Display Time**
Press ◀/▶ to select the menu display time period. The options are 5 sec, 10 sec, 20 sec, 30 sec and Always.
- **Menu Position**
Press ◀/▶ to select the menu display position. The options are Center, Top-Left, Top-Right, Bottom-Right and Bottom-Left.
- **Reminder Message**
Press ◀/▶ to enable or disable reminder message displays.

Operation Settings menu



- **Direct Power On**
Press ◀/▶ to enable or disable automatically turning on the projector when the AC power is connected.
- **Signal Power On**
Press ◀/▶ to enable or disable automatically turning on the projector when an input signal is detected.
- **Auto Power Off**
Press ◀/▶ to enable or disable automatically turning off the projector when there is no input signal.
- **Blank Timer**
Press ◀/▶ to set the length of time the image is blanked. The options are Disable, 5 mins, 10 mins, 15 mins, 20 mins, 25 mins and 30 mins.
- **Sleep Timer**
Press ◀/▶ to set the length of time before the projector is turned off. The options are Disable, 30 mins, 1 hr, 2 hrs, 3 hrs, 4 hrs, 8 hrs and 12 hrs.
- **Filter Settings**
Press **ENTER** to enter the **Filter Settings** menu. See "[Filter Settings menu](#)" on page 49 for more details.

Filter Settings menu

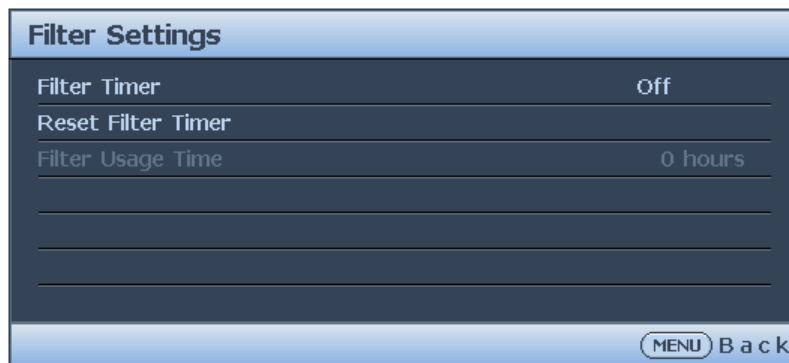

- **Filter Timer**
Press ◀/▶ to enable or disable filter timer.
- **Reset Filter Timer**
Press **ENTER** to reset the filter timer when the filter is replaced.
- **Filter Usage Time**
Displays the current number of hours the filter has been used.

System Setup :Advanced menu

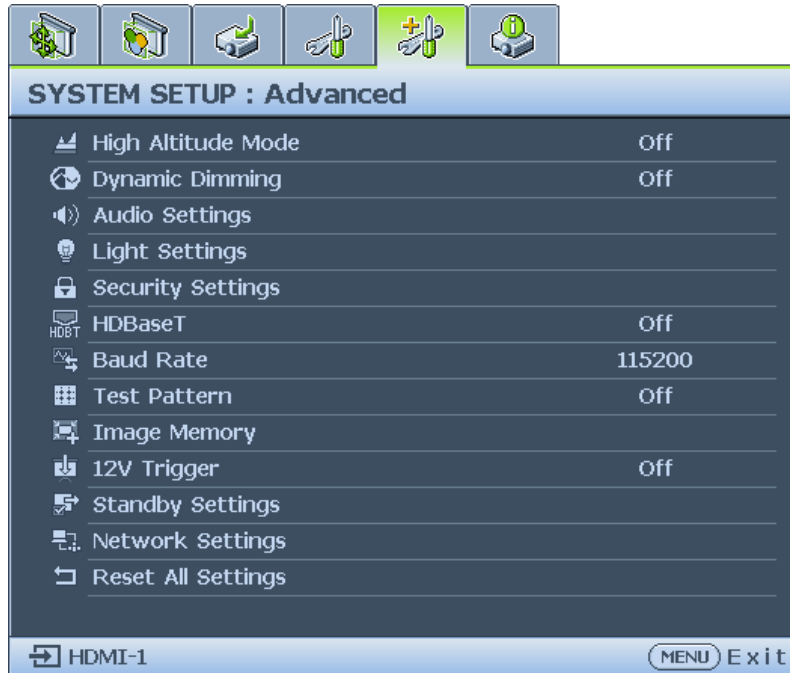

- **High Altitude Mode**
Press ◀/▶ to enable or disable High Altitude Mode. Enable this function when the operating altitude is higher than 1500m or the ambient temperature is over 40°C.
- **Dynamic Dimming**
Press ◀/▶ to enable or disable dynamic dimming function. Enable the function to automatically reduces the screen's brightness level when the displayed image contains a high proportion of bright areas.
When **3D Sync Mode** is **DLP Link**, the **Dynamic Dimming** function is not available.
- **Audio Settings**
Press **ENTER** to enter the **Audio Settings** menu. See "[Audio Settings menu](#)" on page 52 for more details.
- **Light Settings**
Press **ENTER** to enter the **Light Settings** menu. See "[Light Settings menu](#)" on page 53 for more details.
- **Security Settings**
Press **ENTER** to enter the **Security Settings** menu. See "[Security Settings menu](#)" on page 53 for more details.
- **HDBaseT**
Press ◀/▶ to enable or disable the HDBaseT.

Note:

- Turn on HDBaseT mode will disable internal LAN and RS232 control and switch to Normal power standby mode automatically.
- When high altitude mode on, power force to 85%.

HDBaseT control function table

Control Side	Function	Standby Mode			Remark
		Eco (< 0.5W)	Network (<2W)	Normal (>2W)	
Projector	Front-IR (Wireless)	○	○	○ (Can disable by OSD)	
	Rear-IR (Wireless)	○	○	○ (Can disable by OSD)	
	RS-232	○	○	X	
	RJ45/LAN	X	○	X	
	Wired Remote	○	○	○	
HDBaseT TX Box	HDBT-IR (Wireless)	X	X	○	
	RS-232	X	X	○	
	RJ45/LAN	X	X	○	
	Wired Remote	X	X	○	User can connect wired remote at HDBaseT TX side to get the wired function.

○: Enable X: Disable

- **Baud Rate**

Press ◀/▶ to select RS-232 baud rate. The rate is fixed at 9600 for HDBaseT mode. The baud-rate option is only available when a 9-pin RS-232 connector is in use.

- **Test Pattern**

Press ◀/▶ to select the test pattern. The options are Off, Grid, White, Red, Green, Blue, Black, RGB Ramps, Color Bar, Step Bars, CheckBoard, Horizontal Lines, Vertical Lines, Diagonal Lines, Horizontal Ramp and Vertical Ramps.

- **Image Memory**

To enable users to save and apply a set of image settings customized for regularly used circumstance by source and timing

- **I2V Trigger**

Press ◀/▶ to enable or disable I2V trigger function.

- **Standby Settings**

Press **ENTER** to enter the **Standby Settings** menu. See "[Standby Settings menu](#)" on [page 54](#) for more details.

- **Network Settings**

Press **ENTER** to enter the **Network Settings** menu. See "[Network Settings menu](#)" on [page 55](#) for more details.

- **Reset All Settings**

Press **ENTER** to reset all settings to default value.

Audio Settings menu

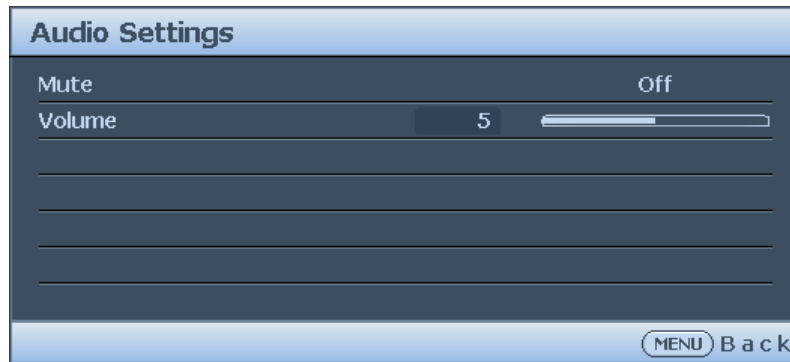

- **Mute**

Press ◀/▶ to enable or disable the mute function.

- Using the remote control

Press **MUTE** to temporarily turn off the sound. While the sound is off, the screen will display in the upper right corner of the screen.

To restore the sound, press **MUTE** again.

- Using the OSD menu

1. Press **MENU** and then press ◀/▶ until the **System Setup: Advanced** menu is highlighted.
2. Press ▼ to highlight **Audio Settings** and press **ENTER**. The Audio Settings page displays.
3. Highlight **Mute** and press ◀/▶ to select **On**.
4. To restore the sound, repeat steps 1-3 and press ◀/▶ to select **Off**.

- **Volume**

Press ◀/▶ to adjust the volume of the projector.

- Using the remote control

Press **VOLUME+/VOLUME-** to select a desired sound level.

- Using the OSD menu

1. Press **MENU** and then press ◀/▶ until the **System Setup: Advanced** menu is highlighted.
2. Press ▼ to highlight **Audio Settings** and press **ENTER**. The Audio Settings page displays.
3. Press ▼ to highlight **Volume** and press ◀/▶ to select a desired sound level.

Light Settings menu

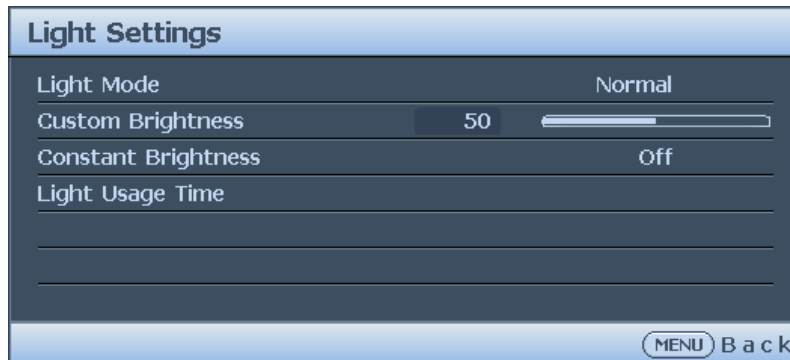

- **Light Mode**
Press ◀/▶ to select the light mode. The options are Normal, Economic, Dimming and Custom.
- **Custom Brightness**
Press ◀/▶ to adjust the brightness of the projector.
- **Constant Brightness**
Press ◀/▶ to enable or disable the function to maintain the brightness at similar level.
- **Light Usage Time**
Press **ENTER** to enter the **Light Source Information** menu.

Security Settings menu



- **Change Password**
Press **ENTER** to change the password.
- **Change Security Settings**
Press **ENTER** to change the security settings.
- **Power On Lock**
Press ◀/▶ to enable or disable the power on lock function. If the function is enabled, you must enter the password every time the projector is turned on.

Standby Settings menu



- **Standby Mode**
Press ◀/▶ to select the standby mode. The options are Eco, Network and Normal.
- **Auto Disable Network Standby Mode**
Press ◀/▶ to enable or disable the auto switch from network standby mode to non-network standby mode after a period of time.
- **Audio Pass Through**
Press ◀/▶ to enable the audio line-out function when the projector is in standby mode. The options are Audio In, HDMI 1, HDMI 2 and Off.

Network Settings menu



- **Wired LAN**
Press **ENTER** to enter the **Wired LAN** menu to setup the IP address, subnet mask, default gateway, DNS server and DHCP.
- **AMX Device Discovery**
Press **◀/▶** to enable or disable the AMX device discovery function. When the function is enabled, the projector can be detected by an AMX controller.
- **Mac Address**
Displays the current MAC address of the projector.

Information menu

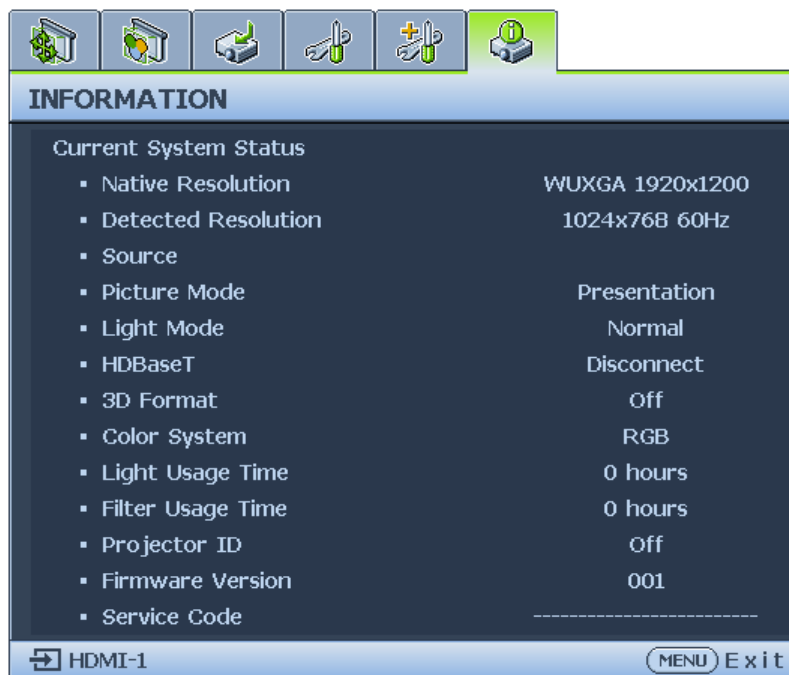

- **Native Resolution**
Displays the native resolution of the model.
- **Detected Resolution**
Displays the detected timing.
- **Source**
Displays the current signal source.
- **Picture Mode**
Displays the current picture mode.

- **Light Mode**
Displays the current light mode.
- **HDBaseT**
Displays the current HDBaseT status.
- **3D Format**
Displays the current 3D mode. Only available when 3D Mode is enabled.
- **Color System**
Displays the input system format.
- **Light Usage Time**
Displays the number of hours the light has been used.
- **Filter Usage Time**
Displays the number of hours the filter has been used.
- **Projector ID**
Displays the current projector ID.
- **Firmware Version**
Displays the firmware version of your projector.
- **Service Code**
Displays the serial number of your projector.

Menu structure

Main menu	Sub-menu	Options	
Display	Wall Color	Off / Light Yellow / Pink / Light Green / Blue / Blackboard	
	Aspect Ratio	Auto / Real / 4 : 3 / 16 : 9 / 16 : 10 / 2.4 : 1	
	2D Keystone	H: -15~0~15 / V: -15~0~15	
	Corner Fit	Top Left / Top Right / Bottom Left / Bottom Right	
	Position	H: -5~0~5 / V: -5~0~5	
	Phase	0~AUTO~31	
	H.size	-15~0~15	
	Digital Image Resizing	Digital Zoom	PC:1.0X~2.0X Video : 1.0~1.8X
		Digital Shrink	0.8X~1.0X
		Digital Image Shift	Digital Image Shift
		Blanking	Top/ Bottom / Left / Right / Reset
	Native Resolution	Display Resolution	WUXGA / 1080P
		Digital Lens Shift	
	Overscan		Composite / S-Video : 0- 3 others : 0-3
	3D	3D Sync Mode	DLP Link / VESA 3D
		3D Mode	Auto / Frame Sequential/ Frame Packing / Top-Bottom/ Side-By-Side / Off
		3D Sync Invert	Disable / Invert
		3D Sync Out Delay	0~359
		3D Sync Out Reference	3D VESA / Bypass
		Save 3D Settings	3D Settings 1 / 3D Settings 2 / 3D Settings 3
Apply 3D Settings		3D Settings 1 / 3D Settings 2 / 3D Settings 3 / Off	
Fast Mode		On / Off	

Main menu	Sub-menu	Options
Picture	Picture Mode	Bright / Presentation / sRGB / Infographic / Video / DICOM SIM / (3D) / (HDR10) / (HLG) / User 1 / User 2
	Reference Mode	Bright / Presentation / sRGB / Infographic / Video / DICOM SIM / 3D / HDR 10 / HLG
	Brightness	0 ~50~100
	Contrast	-50~0~50
	Color	-50~0~50
	Tint	-50~0~50
	Sharpness	0~15~31
	Brilliant Color	0~10
	Gamma Selection	1.8 / 2.0 / 2.1 / 2.2 / 2.3 / 2.4 / 2.6 / DICOM / BenQ
	HDR Brightness	-2/ -1 / 0 / 1 / 2
	Color Temperature	Cool / Normal / Warm
	Color Temperature Fine Tuning	R Gain / G Gain / B Gain / R Offset / G Offset / B Offset
	3D Color Management	Primary Color (R / G / B / C / M / Y) Primary Color (W)
	Reset Picture Settings	HUE / Saturation / Gain Red Gain / Green Gain / Blue Gain Current / All / Cancel
Source	Quick Auto Search	On / Off
	HDR	Auto / SDR / HDR 10 / HLG
	HDMI Format	Auto / RGB Limited / RGB Full / YUV Limited / YUV Full
	HDMI EDID	Enhanced/ Standard
	HDMI Equalizer	HDMI-1 Auto / Lower / Low / Middle / High / Higher
		HDMI-2 Auto / Lower / Low / Middle / High / Higher
	Auto Sync	On / Off
System Setup: Basic	Language	English / Français / Deutsch / Italiano / Español / Русский / 繁體中文 / 简体中文 / 日本語 / 한국어 / Svenska / Nederlands / Türkçe / Čeština / Português / ਪੰਜਾਬੀ / Polski / Magyar / Hrvatski / Română / Norsk / Dansk / Български / Suomi / Indonesian / Ελληνικά / العربية / हिन्दी
	Projector Installation	Front Table / Rear Table / Rear Ceiling / Front Ceiling

Main menu	Sub-menu	Options	
System Setup: Basic	Menu Settings	Menu Display Time	5 sec / 10 sec / 20 sec / 30 sec / Always
		Menu Position	Center / Top-Left / Top-Right / Bottom-Right / Bottom-Left
		Reminder Message	On / Off
	Operation Settings	Direct Power On	On / Off
		Signal Power On	Computer: On / Off HDMI-I: On / Off
		Auto Power Off	Disable / 3 mins / 10 mins / 15 mins / 20 mins / 25 mins / 30 mins
		Blank Timer	Disable / 5 min / 10 min / 15 min / 20 min / 25 min / 30 min
		Sleep Timer	Disable / 30 min / 1 hr / 2 hr / 3 hr / 4 hr / 8 hr / 12 hr
		Filter Settings	Filter Timer: On / Off Reset Filter Timer: Reset / Cancel Filter Usage Time
		Panel Key Lock	On / Off
	Background Color	BenQ / Black / Blue / Purple / Gray	
	Splash Screen	BenQ / Black / Blue	
	Rear Light	On / Off	
	Projector ID Setting	Off / 01 / 02 / ... / 99	
	System Setup: Advanced	High Altitude Mode	On / Off
Dynamic Dimming		On / Off	
Audio Settings		Mute	On / Off
		Volume	
Light Settings		Light Mode	Normal / Economic / Dimming / Custom
		Custom Brightness	25%-100%
		Constant Brightness	On / Off
		Light Usage Time	Light Usage Time / Normal Mode / ECO Mode / Dimming Mode / Custom Mode
Security Settings		Change Password	
		Change Security Settings	
		Power On Lock	On / Off
HDBaseT			On / Off
Baud Rate			2400 / 4800 / 9600 / 14400 / 19200 / 38400 / 57600 / 115200
Test Pattern			Off / Grid / White / Red / Green / Blue / Black / RGB Ramps / Color Bar / Step Bars / CheckBoard / Horizontal Lines / Vertical Lines / Diagonal Lines / Horizontal Ramp / Vertical Ramps

Main menu	Sub-menu		Options	
System Setup: Advanced	Image Memory	Save Image Memory	Memory-1 / Memory-2 / Memory-3 / Memory-4 / Memory-5	
		Apply Image Memory	Memory-1 / Memory-2 / Memory-3 / Memory-4 / Memory-5	
	12V Trigger		On / Off	
	Standby Settings	Standby Mode		Eco/ Network / Normal
		Auto Disable Network Standby Mode		Never / 20 min / 1 hr / 3 hr / 6 hr
		Audio Pass Through		Off / Audio In / HDMI 1/ HDMI 2 / DISPLAY PORT / HDBaseT
	Network Settings	Wired LAN		Status
				DHCP
				IP Address
				Subnet Mask
			Default Gateway	
		DNS Server		
		Apply		
		AMX Device Discovery	On / Off	
		Mac Address		
	Reset All Settings		Reset / Cancel	
Information	Current System Status	Native Resolution	WUXGA 1920x1200 1080p 1920x1080	
		Detected Resolution		
		Source		
		Picture Mode		
		Light Mode		
		HDBaseT	Connect / Disconnect	
		3D Format		
		Color System		
		Light Usage Time		
		Filter Usage Time	Appears when Filter Timer On	
		Projector ID		
		Firmware Version		
		Service Code	SN	

Maintenance

Before maintaining the projector

- Make sure to turn off the power before maintaining the projector.
- When switching off the projector, make sure to follow the procedures in "[Switch off the projector](#)" on page 34.

Care of the projector

Your projector needs little maintenance. The only thing you need to do on a regular basis is to keep the lens clean.

Never remove any parts of the projector. Contact your dealer if other parts need replacing.

Clean the lens front surface

Clean the lens whenever you notice dirt or dust on the surface.

- Use a canister of compressed air to remove dust.
- If there is dirt or smears, use lens-cleaning paper or moisten a soft cloth with lens cleaner and gently wipe the lens surface.



Caution:

Never use any type of abrasive pad, alkaline/acid cleaner, scouring powder, or volatile solvent, such as alcohol, benzene, thinner or insecticide. Using such materials or maintaining prolonged contact with rubber or vinyl materials may result in damage to the projector surface and cabinet material.

Clean the projector case

Before you clean the case, turn the projector off using the proper shutdown procedure as described in "[Switch off the projector](#)" on page 34 and unplug the power cord.

- To remove dirt or dust, wipe the case with a soft, lint-free cloth.
- To remove stubborn dirt or stains, moisten a soft cloth with water and a neutral pH detergent. Then wipe the case.



Caution:

Never use wax, alcohol, benzene, thinner or other chemical detergents. These can damage the case.

Filter maintenance

Cleaning the filter

The air filter prevents dust from accumulating on the surface of the optical elements inside the projector. If the filter is dirty or clogged, your projector may overheat or degrading the projected image quality.

1. Turn off the projector, and unplug the AC power cord from the AC outlet.
2. Cleaning the filter with a vacuum cleaner.

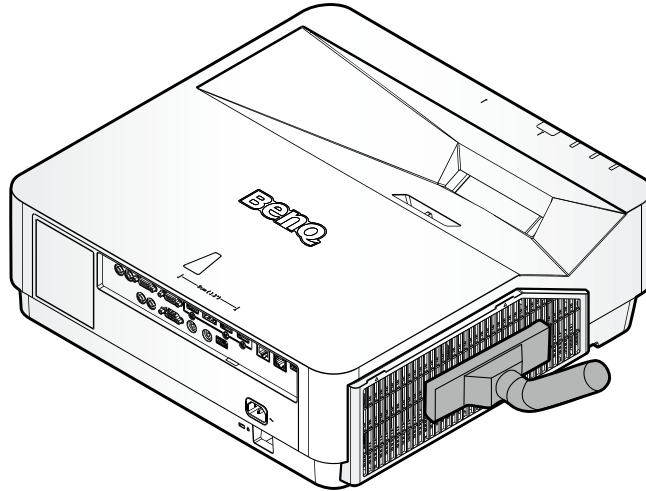

Caution:

Recommend avoiding dusty or smoky environments when you operate the projector; it may cause poor image quality. If the filter is heavily clogged and unable to clean, replace a new filter.

Note:

Using a ladder is recommended to access the filter. Do not remove the projector from the wall mount.

Replacing the filter

1. Turn off the projector and unplug the power cord from the outlet. Remove any dust on the projector and around the air vents.
Loosen the two hooks that secure the filter module.
2. Remove the filter module from the projector.

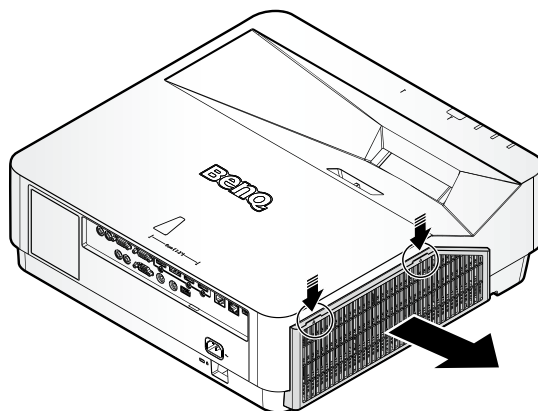

3. Replace the filter module with the new filter.
4. Replace the filter module onto the projector by pushing gently in the direction shown, make sure the two hooks that secure the filter module.

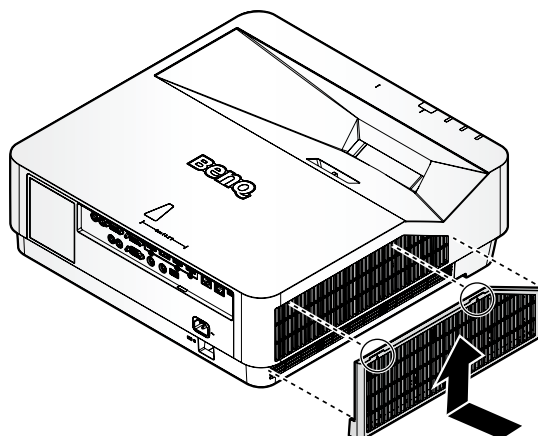

Note:

Do not wash the filter with the water or other liquid matter.

LED indicator

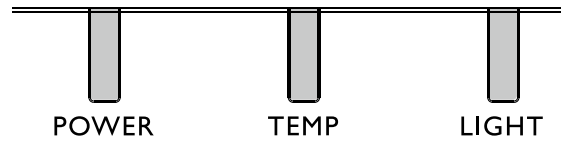

LED Usage

LED Name	Detailed Description
Power LED	Display the power on/off sequence status Orange : Power Off (Green + Red) Green : Power On Blink : Warming up/Shutting Down & Cooling / Error Code
Temperature Status LED	Display the Thermal status (Fan Fail, Over Temperature, etc.) Red : Thermal Over Temperature Blink : Error Code
Lamp Status LED	Display the Lamp status (Lamp fail, Lamp spoil etc.) Red : Lamp Fail Blink : Error Code

System message

Power	Temp	Light	Status & Description
Orange	-	-	Stand-by
Green Flashing	-	-	Powering up
Green	-	-	Normal operation
Orange Flashing	-	-	Normal power-down cooling
Red Flashing	Red Flashing	Red Flashing	Download
Green	-	Red	CW start fail
Green	-	Red Flashing	Phosphor Wheel start fail
Red Flashing	-	-	Scaler shutdown fail(data aboard)
Red	-	Red	Scaler reset fail(video projector only)
-	Red	-	LAN download fail
-	Green	-	LAN download processing
Orange	-	Green Flashing	Light source life exhausted
Orange	-	Green	Lens release

Power	Temp	Light	Status & Description
Orange	-	Red	Case open
Orange	-	Red Flashing	Filter replace warning
Orange	Green Flashing	-	Thermal break sensor error

Burn-In Messages

Power	Temp	Light	Status & Description
Green	-	-	Burn-in ON
Green	Green	Green	Burn-in OFF

Lamp Error Messages

Power	Temp	Light	Status & Description
-	-	Red	Lamp1 error in normal operation
-	-	-	Lamp2 error in normal operation
-	-	Red	Both Lamp fail
-	-	Red Flashing	Lamp is not lit up

Thermal Error Messages

Power	Temp	Light	Status & Description
Red	Red	-	Fan 1 error (the actual fan speed is outside the desired speed)
Red	Red Flashing	-	Fan 2 error (the actual fan speed is outside the desired speed)
Red	Green	-	Fan 3 error(the actual fan speed is outside the desired speed)eed)
Red	Green Flashing	-	Fan 4 error (the actual fan speed is outside the desired speed)
Red Flashing	Red	-	Fan 5 error (the actual fan speed is outside the desired speed)
Red Flashing	Red Flashing	-	Fan 6 error (the actual fan speed is outside the desired speed)
Red Flashing	Green	-	Fan 7 error (the actual fan speed is outside the desired speed)
Red Flashing	Green Flashing	-	Fan 8 error (the actual fan speed is outside the desired speed)
Red	Green	Red Flashing	Fan 9 error (the actual fan speed is outside the desired speed)
Red	Green	Red	Fan 10 error (the actual fan speed is outside the desired speed)

Power	Temp	Light	Status & Description
Red	Green Flashing	Red Flashing	Fan I1 error (the actual fan speed is outside the desired speed)
Red	Green Flashing	Red	Fan I2 error (the actual fan speed is outside the desired speed)
Green	Red	-	Temperature 1 error (over limited temperature)
Green	Red Flashing	-	Thermal Sensor 1 open error
Green	Green	-	Thermal Sensor 1 short error
Green	Green Flashing	-	Thermal IC #1 I2C Connection error
Green Flashing	Red	-	Temperature 2 error (over limited temperature)
Green Flashing	Red Flashing	-	Thermal Sensor 2 open error
Green Flashing	Green	-	Thermal Sensor 2 short error
Green Flashing	Green Flashing	-	Thermal IC #2 I2C Connection error
Green	Red	Red	Temperature 3 error (over limited temperature)
Green	Red	Red Flashing	Thermal Sensor 3 open error
Green	Red	Green	Thermal Sensor 3 short error
Green	Red	Green Flashing	Thermal IC #3 I2C Connection error
Green	Red Flashing	Red	Temperature 4 error (over limited temperature)
Green	Red Flashing	Red Flashing	Thermal Sensor 4 open error
Green	Red Flashing	Green	Thermal Sensor 4 short error
Green	Red Flashing	Green Flashing	Thermal IC #4 I2C Connection error
Orange	Red	Red	Temperature 5 error (over limited temperature)
Orange	Red	Red Flashing	Thermal Sensor 5 open error
Orange	Red	Green	Thermal Sensor 5 short error
Orange	Red	Green Flashing	Thermal IC #5 I2C Connection error

Troubleshooting

Troubleshooting

The projector does not turn on.

Cause	Remedy
There is no power from the power cable.	Plug the power cord into the AC inlet on the projector, and plug the power cord into the power outlet. If the power outlet has a switch, make sure that it is switched on.
Attempting to turn the projector on again during the cooling process.	Wait until the cooling down process has completed.

No picture.

Cause	Remedy
The video source is not turned on or connected correctly.	Turn the video source on and check that the signal cable is connected correctly.
The projector is not correctly connected to the input signal device.	Check the connection.
The input signal has not been correctly selected.	Select the correct input signal with the SOURCE key on the projector or remote control.

Blurred image.

Cause	Remedy
The projection lens is not correctly focused.	Adjust the focus of the lens using the focus ring.
The projector and the screen are not aligned properly.	Adjust the projection angle and direction as well as the height of the unit if necessary.

Remote control does not work.

Cause	Remedy
The battery is out of power.	Replace the battery with new one.
There is an obstacle between the remote control and the projector.	Remove the obstacle.
You are too far away from the projector.	Stand within 7 meters (23 feet) of the projector.

The password is incorrect.

Cause	Remedy
You do not remember the password.	<ol style="list-style-type: none"> 1. Press and hold AUTO on the projector or remote control for 3 seconds. The projector will display a coded number on the screen. 2. Write down the number and turn off your projector. 3. Seek help from the local BenQ service center to decode the number. You may be required to provide proof of purchase documentation to verify that you are an authorized user of the projector.

Specifications

Specifications

Optical

Resolution

LU960UST
1920 x 1200

Display system

Single-chip DLP™ system

Light source

Laser diodes

Electrical

Power supply

AC100-240V
50/60 Hz (Automatic)
7.0A

Power consumption

450W (Max); < 0.5W (Standby)

Mechanical

Weight

26.4 lbs (12 Kg) (without lens)

Dimension

480x157.4x473 mm (18.90"x6.20"x18.62")

Output terminals

Speaker

10 watt x 1 (RMS)

Audio signal output

PC audio jack x 1

Monitor Out

D-Sub 15-pin (female) x1

USB

TYPE-A (5V/1.5A)

HDMI OUT x 1

3D SYNC OUT x 1

Control

USB

Mini USB x1 (for service)

RS-232 serial control

9 pin x 1 (In)

IR receiver x 1

12V TRIGGER

12VDC (Max. 0.2 A) x 1

LAN control

RJ45 x 1 (10/100Mbps)

Wired Remote

PC audio jack x 1

Input terminals

Computer input

Digital input

15-pin VGA port x 1

Video signal input

COMPONENT

Share 15 pin VGA port

SD/HDTV signal input

Digital - HDMI x 1

HDMI 2 x 1

RJ45 x1 (HDBaseT)

Audio signal input

Audio in

PC audio jack x 1

Environmental Requirements

Operating temperature

0°C–40°C at sea level (>35°C, power force to 80%)

Operating relative humidity

10%–90% (without condensation)

Operating altitude

0–1499 m at 0°C–35°C

1500–3000 m at 0°C–30°C (with High

Altitude Mode on and power force to 85%)

Storage temperature

-20°C–60°C

Storage humidity

10%–90% RH (without condensation)

Note:

All specifications are subject to change without notice.

Dimensions

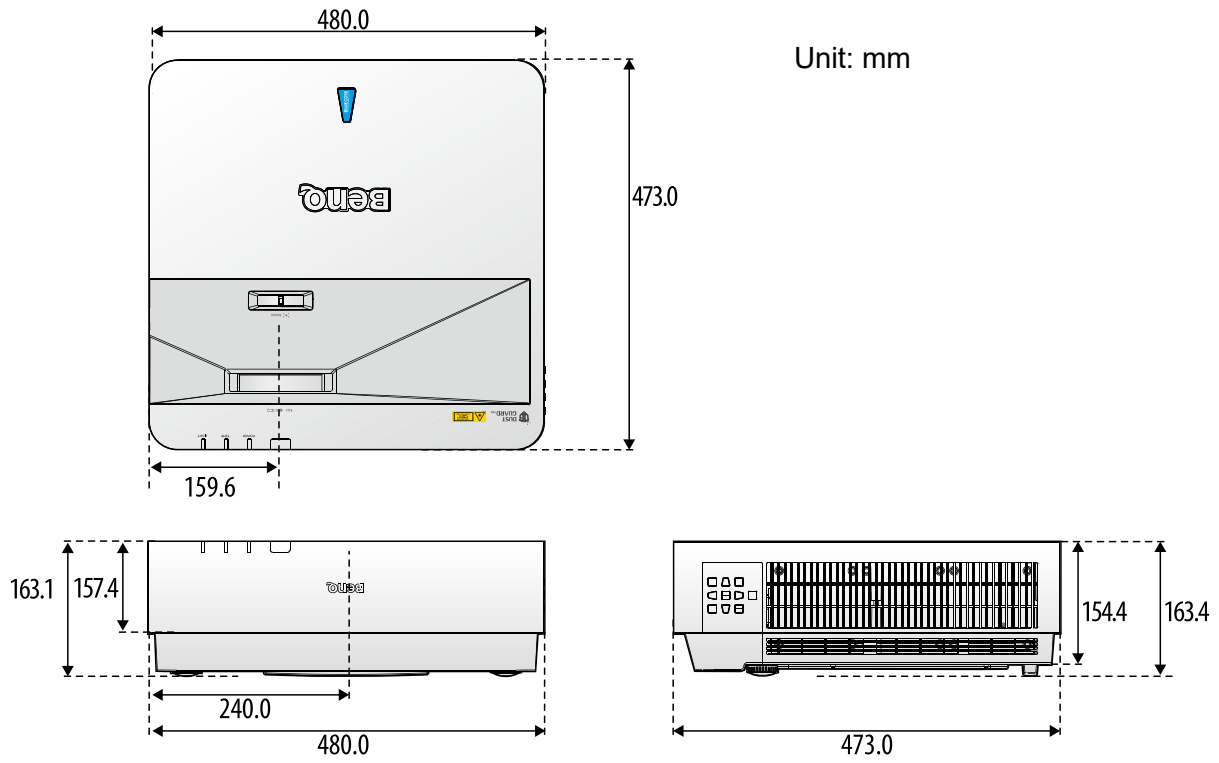

Attaching for ceiling mount

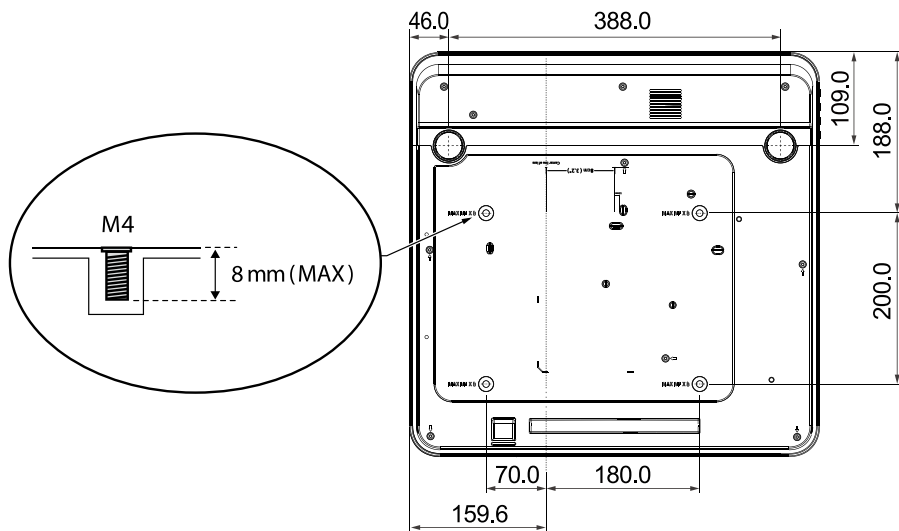

Appendix

Timing table

Support video timing for HDMI input

Timing	Resolution	H-frequency (kHz)	V-frequency (Hz)	Dot Clock Frequency (MHz)	User Manual Supported	3D Field	3D frame packing	3D over-under	3D side-by-side
480i	720(1440) x 480	15.73	59.94	27	Yes	⊙			
480p	720 x 480	31.47	59.94	27	Yes	⊙			
576i	720(1440) x 576	15.63	50	27	Yes				
576p	720 x 576	31.25	50	27	Yes				
720/50p	1280 x 720	37.5	50	74.25	Yes		⊙	⊙	⊙
720/60p	1280 x 720	45	60	74.25	Yes	⊙	⊙	⊙	⊙
1080/24P	1920 x 1080	27	24	74.25	Yes		⊙	⊙	⊙
1080/25P	1920 x 1080	28.13	25	74.25	Yes				
1080/30P	1920 x 1080	33.75	30	74.25	Yes				
1080/50i	1920 x 1080	28.13	50	74.25	Yes				⊙
1080/60i	1920 x 1080	33.75	60	74.25	Yes				⊙
1080/50P	1920 x 1080	56.25	50	148.5	Yes			⊙	⊙
1080/60P	1920 x 1080	67.5	60	148.5	Yes			⊙	⊙
2160/24P	3840 x 2160	54	24	297	Yes				
2160/25P	3840 x 2160	56.25	25	297	Yes				
2160/30P	3840 x 2160	67.5	30	297	Yes				
2160/50P	3840 x 2160	112.5	50	594	Yes				
2160/60P	3840 x 2160	135	60	594	Yes				

Support PC timing for HDMI input

Resolution	Mode	Refresh rate (Hz)	H-frequency (kHz)	Clock (MHz)	User Manual Supported	3D Field	3D over-under	3D side-by-side
640 x 480	VGA_60	59.94	31.469	25.175	Yes	⊙	⊙	⊙
	VGA_72	72.809	37.861	31.5	Yes			
	VGA_75	75	37.5	31.5	Yes			
	VGA_85	85.008	43.269	36	Yes			
	VGA_120**	119.518	61.91	52.5	Yes			
720 x 400	720x400_70	70.087	31.469	28.3221	Yes			

Resolution	Mode	Refresh rate (Hz)	H-frequency (kHz)	Clock (MHz)	User Manual Supported	3D Field	3D over-under	3D side-by-side
800 x 600	SVGA_60	60.317	37.879	40	Yes	⊙	⊙	⊙
	SVGA_72	72.188	48.077	50	Yes			
	SVGA_75	75	46.875	49.5	Yes			
	SVGA_85	85.061	53.674	56.25	Yes			
	SVGA_120 (Reduce Blanking)	119.854	77.425	83	Yes	⊙		
1024 x 768	XGA_60	60.004	48.363	65	Yes	⊙	⊙	⊙
	XGA_70	70.069	56.476	75	Yes			
	XGA_75	75.029	60.023	78.75	Yes			
	XGA_85	84.997	68.667	94.5	Yes			
	XGA_120 (Reduce Blanking)	119.989	97.551	115.5	Yes	⊙		
1152 x 864	1152 x 864_75	75	67.5	108	Yes			
1024x576	BenQ Notebook Timing	60	35.82	46.996	Yes			
1024x600	BenQ Notebook Timing	64.995	41.467	51.419	Yes			
1280x720	1280 x 720_60	60	45	74.25	Yes	⊙	⊙	⊙
	1280x720_120	120	90	148.5	No	⊙		
1280 x 768	1280 x 768_60 (Reduce Blanking)	60	47.396	68.25	No	⊙	⊙	⊙
	1280 x 768_60	59.87	47.776	79.5	Yes	⊙	⊙	⊙
1280 x 800	WXGA_60	59.81	49.702	83.5	Yes	⊙	⊙	⊙
	WXGA_75	74.934	62.795	106.5	Yes			
	WXGA_85	84.88	71.554	122.5	Yes			
	WXGA_120 (Reduce Blanking)	119.909	101.563	146.25	Yes	⊙		
1280 x 1024	SXGA_60	60.02	63.981	108	Yes		⊙	⊙
	SXGA_75	75.025	79.976	135	Yes			
	SXGA_85	85.024	91.146	157.5	Yes			
1280 x 960	1280 x 960_60	60	60	108	Yes		⊙	⊙
	1280 x 960_85	85.002	85.938	148.5	Yes			
1360 x 768	1360 x 768_60	60.015	47.712	85.5	Yes		⊙	⊙
1440 x 900	WXGA+_60 (Reduce Blanking)	60	55.469	88.75	No		⊙	⊙
	WXGA+_60	59.887	55.935	106.5	Yes		⊙	⊙
1400X1050	SXGA+_60	59.978	65.317	121.75	Yes		⊙	⊙
1600x1200	UXGA	60	75	162	Yes		⊙	

Resolution	Mode	Refresh rate (Hz)	H-frequency (kHz)	Clock (MHz)	User Manual Supported	3D Field	3D over-under	3D side-by-side
1680x1050	1680x1050_60 (Reduce Blanking)	59.883	64.674	119	No		⊙	⊙
	1680x1050_60	59.954	65.29	146.25	Yes		⊙	⊙
640x480 @67Hz	MACI3	66.667	35	30.24	Yes			
832x624 @75Hz	MACI6	74.546	49.722	57.28	Yes			
1024x768 @75Hz	MACI9	75.02	60.241	80	Yes			
1152x870 @75Hz	MAC21	75.06	68.68	100	Yes			
1920x1080 @60HZ	1920X1080_60 (Reduce Blanking)	60	67.5	148.5	Yes	⊙	⊙	⊙
1920x1200 @60HZ	1920X1200_60 (Reduce Blanking)	59.95	74.038	154	Yes	⊙	⊙	⊙
1920X1080 (VESA)	1920X1080_60 (for Auditorium model)	59.963	67.158	173	No			
"1920x1080 @120Hz"	1920X1080_120	120	135	297	Yes	⊙		
"1920x1200 @120Hz"	1920X1200_120 (Reduce Blanking)	119.909	152.404	317	Yes	⊙		
3840x2160	3840X2160_30 (Reduce Blanking)	29.97	65.66	257.404	Yes			
3840x2160	3840X2160_60 (Reduce Blanking)	59.94	133.187	522.092	Yes			
3840x2160	3840X2160_30	30	67.5	297	Yes			
3840x2160	3840X2160_60	60	135	594	Yes			

Support PC timing for PC input

Resolution	Mode	Refresh rate (Hz)	H-frequency (kHz)	Clock (MHz)	User Manual Supported	3D Field	3D over-under	3D side-by-side
720 x 400	720x400_70	70.087	31.469	28.3221	Yes			
640 x 480	VGA_60	59.94	31.469	25.175	Yes	⊙	⊙	⊙
	VGA_72	72.809	37.861	31.5	Yes			
	VGA_75	75	37.5	31.5	Yes			
	VGA_85	85.008	43.269	36	Yes			
800 x 600	SVGA_56	56.25	35.156	36	Yes			
	SVGA_60	60.317	37.879	40	Yes	⊙	⊙	⊙
	SVGA_72	72.188	48.077	50	Yes			
	SVGA_75	75	46.875	49.5	Yes			
	SVGA_85	85.061	53.674	56.25	Yes			
	SVGA_120 (Reduce Blanking)	119.854	77.425	83	Yes	⊙		
1024 x 768	XGA_60	60.004	48.363	65	Yes	⊙	⊙	⊙
	XGA_70	70.069	56.476	75	Yes			
	XGA_75	75.029	60.023	78.75	Yes			
	XGA_85	84.997	68.667	94.5	Yes			
	XGA_120 (Reduce Blanking)	119.989	97.551	115.5	Yes	⊙		
1152 x 864	1152 x 864_75	75	67.5	108	Yes			
1024 x 576	BenQ NB Timing	60	35.82	46.966	Yes			
1024 x 600	BenQ NB Timing	64.995	41.467	51.419	Yes			
1280x720	1280 x 720_60	60	45	74.25	Yes	⊙	⊙	⊙
	1280x720_120	120	90	148.5	No	⊙		
1280 x 768	1280 x 768_60 (Reduce Blanking)	60	47.396	68.25	No	⊙	⊙	⊙
	1280 x 768_60	59.87	47.776	79.5	Yes	⊙	⊙	⊙
1280 x 800	WXGA_60	59.81	49.702	83.5	Yes	⊙	⊙	⊙
	WXGA_75	74.934	62.795	106.5	Yes			
	WXGA_85	84.88	71.554	122.5	Yes			
	WXGA_120	119.909	101.563	146.25	Yes	⊙		
1280 x 1024	SXGA_60	60.02	63.981	108	Yes		⊙	⊙
	SXGA_75	75.025	79.976	135	Yes			
	SXGA_85	85.024	91.146	157.5	Yes			
1280 x 960	1280 x 960_60	60	60	108	Yes		⊙	⊙
	1280 x 960_85	85.002	85.938	148.5	Yes			
1360 x 768	1360 x 768_60	60.015	47.712	85.5	Yes		⊙	⊙

Resolution	Mode	Refresh rate (Hz)	H-frequency (kHz)	Clock (MHz)	User Manual Supported	3D Field	3D over-under	3D side-by-side
1440 x 900	WXGA+_60 (Reduce Blanking)	60	55.469	88.75	No		⊙	⊙
	WXGA+_60	59.887	55.935	106.5	Yes		⊙	⊙
1400X1050	SXGA+_60	59.978	65.317	121.75	Yes		⊙	⊙
1600x1200	UXGA	60	75	162	Yes		⊙	⊙
1680 x 1050	1680x1050_60 (Reduce Blanking)	59.883	64.674	119	No		⊙	⊙
	1680x1050_60	59.954	65.29	146.25	Yes		⊙	⊙
640x480 @67Hz	MAC13	66.667	35	30.24	Yes			
832x624 @75Hz	MAC16	74.546	49.722	57.28	Yes			
1024x768 @75Hz	MAC19	74.93	60.241	80	Yes			
1152x870 @75Hz	MAC21	75.06	68.68	100	Yes			
1920x1080 @60HZ	1920X1080_60	60	67.5	148.5	Yes	⊙	⊙	⊙
1920x1200 @60HZ	1920X1200_60	59.95	74.038	154	Yes	⊙	⊙	⊙
1920X1080 (VESA)	1920X1080_60	59.963	67.158	173	No			

 **Note:**

- There timing showing depend the EDID file and VGA graphic card limitation. It is possible that user cannot choose the above timings on VGA display card.

True 3D Video Compatibility table

Input Resolutions	HDMI I.4a 3D Input	Input timing		
		1280 X 720P @ 50Hz	Top - and - Bottom	
1280 X 720P @ 60Hz	Top - and - Bottom			
1280 X 720P @ 50Hz	Frame packing			
1280 X 720P @ 60Hz	Frame packing			
1920 X 1080i @50 Hz	Side- by-Side (Half)			
1920 X 1080i @60 Hz	Side- by-Side (Half)			
1920 X 1080P @24 Hz	Top - and – Bottom			
1920 X 1080P @24 Hz	Frame packing			
HDMI I.3	1920 x 1080i @ 50Hz	Side-by-Side(Half)	SBS mode is on	
	1920 x1080i @ 60Hz			
	1280 x 720P @50Hz			
	1280 x 720P @60Hz			
	1920 x 1080i @ 50Hz	Top-and-Bottom	TAB mode is on	
	1920 x1080i @ 60Hz			
	1280 x 720P @50Hz			
	1280 x 720P @60Hz			
	480i	HQFS	3D format is Frame sequential	

*When testing 3D, please confirm that the glasses must support up to 144Hz

Support HDMI-1 / HDMI-2 timing for HDBaseT input (Rexton 4K timing)

Timing Name	VHz	RGB						YCbCr422			YCbCr422			YCbCr422		
		Limit range			Full range			Limit range								
		8 Bit	10 Bit	12 Bit	8 Bit	10 Bit	12 Bit	8 Bit	10 Bit	12 Bit	8 Bit	10 Bit	12 Bit	8 Bit	10 Bit	12 Bit
3840p	23.98	⊙			⊙			⊙	⊙	⊙	⊙			⊙		
3840p	24	⊙			⊙			⊙	⊙	⊙	⊙			⊙		
3840p	25	⊙			⊙			⊙	⊙	⊙	⊙			⊙		
3840p	29.97	⊙			⊙			⊙	⊙	⊙	⊙			⊙		
3840p	30	⊙			⊙			⊙	⊙	⊙	⊙			⊙		

RS232 command control

Function	Type	Operation	ASCII
Power	Write	Power On	<CR>*pow=on#<CR>
	Write	Power off	<CR>*pow=off#<CR>
	Read	Power Status	<CR>*pow=?#<CR>
Source Selection	Write	COMPUTER/YPbPr	<CR>*sour=RGB#<CR>
	Write	COMPUTER 2/YPbPr2	<CR>*sour=RGB2#<CR>
	Write	DVI-D	<CR>*sour=dvid#<CR>
	Write	HDMI (MHL)	<CR>*sour=hdmi#<CR>
	Write	HDMI 2 (MHL2)	<CR>*sour=hdmi2#<CR>
	Write	Composite	<CR>*sour=vid#<CR>
	Write	HDBaseT	<CR>*sour=hdbaset#<CR>
	Read	Current source	<CR>*sour=?#<CR>
Audio Control	Write	Mute On	<CR>*mute=on#<CR>
	Write	Mute Off	<CR>*mute=off#<CR>
	Read	Mute Status	<CR>*mute=?#<CR>
	Write	Volume +	<CR>*vol=+#<CR>
	Write	Volume -	<CR>*vol=-#<CR>
	Write	Volume level for customer	<CR>*vol=value#<CR>
	Read	Volume Status	<CR>*vol=?#<CR>
Audio Source Select	Write	Audio pass Through off	<CR>*audiosour=off#<CR>
	Write	Audio-ComputerI	<CR>*audiosour=RGB#<CR>
	Write	Audio-Video/S-Video	<CR>*audiosour=vid#<CR>
	Write	Audio-HDMI	<CR>*audiosour=hdmi#<CR>
	Write	Audio-HDMI2	<CR>*audiosour=hdmi2#<CR>
	Read	Audio pass Status	<CR>*audiosour=?#<CR>
Picture Mode	Write	Presentation	<CR>*appmod=preset#<CR>
	Write	sRGB	<CR>*appmod=srgb#<CR>
	Write	Bright	<CR>*appmod=bright#<CR>
	Write	Cinema (Rec. 709)	<CR>*appmod=cine#<CR>
	Write	DICOM	<CR>*appmod=dicom#<CR>
	Write	Vivid	<CR>*appmod=vivid#<CR>
	Write	User1	<CR>*appmod=user1#<CR>
	Write	User2	<CR>*appmod=user2#<CR>
	Write	3D	<CR>*appmod=threed#<CR>
	Write	HDR10	<CR>*appmod=hdr<CR>
	Write	HLG	<CR>*appmod=hlg<CR>
	Write	Video	<CR>*appmod=video<CR>
	Read	Picture Mode	<CR>*appmod=?#<CR>

Function	Type	Operation	ASCII
Picture Setting	Write	Contrast +	<CR>*con=+#<CR>
	Write	Contrast -	<CR>*con=-#<CR>
	Write	Set Contrast value	<CR>*con=5#<CR>
	Read	Contrast value	<CR>*con=?#<CR>
	Write	Brightness +	<CR>*bri=+#<CR>
	Write	Brightness -	<CR>*bri=-#<CR>
	Write	Set Brightness value	<CR>*bri=5#<CR>
	Read	Brightness value	<CR>*bri=?#<CR>
	Write	Color +	<CR>*color=+#<CR>
	Write	Color -	<CR>*color=-#<CR>
	Write	Set Color value	<CR>*color=5#<CR>
	Read	Color value	<CR>*color=?#<CR>
	Write	Sharpness +	<CR>*sharp=+#<CR>
	Write	Sharpness -	<CR>*sharp=-#<CR>
	Write	Set Sharpness value	<CR>*sharp=5#<CR>
	Read	Sharpness value	<CR>*sharp=?#<CR>
	Write	Color Temperature - Warm	<CR>*ct=warm#<CR>
	Write	Color Temperature - Normal	<CR>*ct=normal#<CR>
	Write	Color Temperature - Cool	<CR>*ct=cool#<CR>
	Read	Color Temperature Status	<CR>*ct=?#<CR>
	Write	Aspect 4:3	<CR>*asp=4:3#<CR>
	Write	Aspect 16:9	<CR>*asp=16:9#<CR>
	Write	Aspect 2.35:1	<CR>*asp=2.35#<CR>
	Write	Aspect 16:10	<CR>*asp=16:10#<CR>
	Write	Aspect Auto	<CR>*asp=AUTO#<CR>
	Write	Aspect Real	<CR>*asp=REAL#<CR>
	Read	Aspect Status	<CR>*asp=?#<CR>
	Write	Vertical Keystone +	<CR>*vkeystone=+#<CR>
	Write	Vertical Keystone -	<CR>*vkeystone=-#<CR>
	Read	Vertical Keystone value	<CR>*vkeystone=?#<CR>
	Write	Horizontal Keystone +	<CR>*hkeystone=+#<CR>
	Write	Horizontal Keystone -	<CR>*hkeystone=-#<CR>
Read	Horizontal Keystone value	<CR>*hkeystone=?#<CR>	
Write	Overscan Adjustment +	<CR>*overscan=+#<CR>	
Write	Overscan Adjustment -	<CR>*overscan=-#<CR>	
Read	Overscan Adjustment value	<CR>*overscan=?#<CR>	

Function	Type	Operation	ASCII
Picture Setting	Write	4 Corners Top-Left - X Decrease	<CR>*cornerfittlx=-#<CR>
	Write	4 Corners Top-Left - X Increase	<CR>*cornerfittlx=+#<CR>
	Read	4 Corners Top-Left - X Status	<CR>*cornerfittlx=?#<CR>
	Write	4 Corners Top-Left - Y Decrease	<CR>*cornerfittly=-#<CR>
	Write	4 Corners Top-Left - Y Increase	<CR>*cornerfittly=+#<CR>
	Read	4 Corners Top-Left - Y Status	<CR>*cornerfittly=?#<CR>
	Write	4 Corners Top-Right - X Decrease	<CR>*cornerfittrx=-#<CR>
	Write	4 Corners Top-Right - X Increase	<CR>*cornerfittrx=+#<CR>
	Read	4 Corners Top-Right - X Status	<CR>*cornerfittrx=?#<CR>
	Write	4 Corners Top-Right - Y Decrease	<CR>*cornerfittry=-#<CR>
	Write	4 Corners Top-Right - Y Increase	<CR>*cornerfittry=+#<CR>
	Read	4 Corners Top-Right - Y Status	<CR>*cornerfittry=?#<CR>
	Write	4 Corners Bottom-Left - X Decrease	<CR>*cornerfitblx=-#<CR>
	Write	4 Corners Bottom-Left - X Increase	<CR>*cornerfitblx=+#<CR>
	Read	4 Corners Bottom-Left - X Status	<CR>*cornerfitblx=?#<CR>
	Write	4 Corners Bottom-Left - Y Decrease	<CR>*cornerfitbly=-#<CR>
	Write	4 Corners Bottom-Left - Y Increase	<CR>*cornerfitbly=+#<CR>
	Read	4 Corners Bottom-Left - Y Status	<CR>*cornerfitbly=?#<CR>
	Write	4 Corners Bottom-Right - X Decrease	<CR>*cornerfitbrx=-#<CR>
	Write	4 Corners Bottom-Right - X Increase	<CR>*cornerfitbrx=+#<CR>
	Read	4 Corners Bottom-Right - X Status	<CR>*cornerfitbrx=?#<CR>
	Write	4 Corners Bottom-Right - Y Decrease	<CR>*cornerfitbry=-#<CR>
	Write	4 Corners Bottom-Right - Y Increase	<CR>*cornerfitbry=+#<CR>
	Read	4 Corners Bottom-Right - Y Status	<CR>*cornerfitbry=?#<CR>
	Write	Digital Zoom In	<CR>*zoomI#<CR>
	Write	Digital Zoom out	<CR>*zoomO#<CR>
	Write	Auto	<CR>*auto#<CR>
	Write	Brilliant color on	<CR>*BC=on#<CR>
	Write	Brilliant color off	<CR>*BC=off#<CR>
	Read	Brilliant color status	<CR>*BC=?#<CR>
	Write	Auto(HDR)	<CR>*hdr=auto#<CR>
	Write	SDR	<CR>*hdr=sdr#<CR>
Write	HDR10	<CR>*hdr=hdr#<CR>	
Write	HLG	<CR>*hdr=hlg#<CR>	
Write	Reset current picture settings	<CR>*rstcurpicsetting#<CR>	
Write	Reset all picture settings	<CR>*rstallpicsetting#<CR>	

Function	Type	Operation	ASCII
Operation Settings	Write	Projector Position-Front Table	<CR>*pp=FT#<CR>
	Write	Projector Position-Rear Table	<CR>*pp=RE#<CR>
	Write	Projector Position-Rear Ceiling	<CR>*pp=RC#<CR>
	Write	Projector Position-Front Ceiling	<CR>*pp=FC#<CR>
	Read	Projector Position Status	<CR>*pp=?#<CR>
	Write	Quick auto search	<CR>*QAS=on#<CR>
	Write	Quick auto search	<CR>*QAS=off#<CR>
	Read	Quick auto search status	<CR>*QAS=?#<CR>
	Write	Menu Position - Center	<CR>*menuposition=center#<CR>
	Write	Menu Position - Top - Left	<CR>*menuposition=tl#<CR>
	Write	Menu Position - Top - Right	<CR>*menuposition=tr#<CR>
	Write	Menu Position - Bottom - Right	<CR>*menuposition=br#<CR>
	Write	Menu Position - Bottom - Left	<CR>*menuposition=bl#<CR>
	Read	Menu Position Status	<CR>*menuposition=?#<CR>
	Write	Direct Power On - on	<CR>*directpower=on#<CR>
	Write	Direct Power On - off	<CR>*directpower=off#<CR>
	Read	Direct Power On - Status	<CR>*directpower=?#<CR>
	Write	Signal Power On - on	<CR>*autopower=on#<CR>
	Write	Signal Power On - off	<CR>*autopower=off#<CR>
	Read	Signal Power On - Status	<CR>*autopower=?#<CR>
Baud Rate	Write	2400	<CR>*baud=2400#<CR>
	Write	4800	<CR>*baud=4800#<CR>
	Write	9600	<CR>*baud=9600#<CR>
	Write	14400	<CR>*baud=14400#<CR>
	Write	19200	<CR>*baud=19200#<CR>
	Write	38400	<CR>*baud=38400#<CR>
	Write	57600	<CR>*baud=57600#<CR>
	Write	115200	<CR>*baud=115200#<CR>
	Read	Current Baud Rate	<CR>*baud=?#<CR>
Lamp Control	Read	Lamp Hour	<CR>*ltime=?#<CR>
	Write	Normal mode	<CR>*lampm=lnor#<CR>
	Write	Eco mode	<CR>*lampm=eco#<CR>
	Write	Dimming mode	<CR>*lampm=dimming#<CR>
	Write	Custom mode	<CR>*lampm=custom#<CR>
	Write	Light level for custom mode	<CR>*lampcustom=value#<CR>
	Read	Light level status for custom mode	<CR>*lampcustom=?#<CR>
	Read	Lamp Mode Status	<CR>*lampm=?#<CR>

Function	Type	Operation	ASCII
Miscellaneous	Read	Model Name	<CR>*modelName=?#<CR>
	Read	System F/W Version	<CR>*sysfwversion=?#<CR>
	Read	Scaler F/W Version	<CR>*scalerfwversion=?#<CR>
	Read	Lan F/W Version	<CR>*lanfwversion=?#<CR>
	Read	MCU F/W Version	<CR>*mconfwversion=?#<CR>
	Write	Blank On	<CR>*blank=on#<CR>
	Write	Blank Off	<CR>*blank=off#<CR>
	Read	Blank Status	<CR>*blank=?#<CR>
	Write	Freeze On	<CR>*freeze=on#<CR>
	Write	Freeze Off	<CR>*freeze=off#<CR>
	Read	Freeze Status	<CR>*freeze=?#<CR>
	Write	Menu On	<CR>*menu=on#<CR>
	Write	Menu Off	<CR>*menu=off#<CR>
	Read	Menu Status	<CR>*menu=?#<CR>
	Write	Up	<CR>*up#<CR>
	Write	Down	<CR>*down#<CR>
	Write	Right	<CR>*right#<CR>
	Write	Left	<CR>*left#<CR>
	Write	Enter	<CR>*enter#<CR>
	Write	Back	<CR>*back#<CR>
	Write	Source Menu On	<CR>*sourmenu=on#<CR>
	Write	Source Menu Off	<CR>*sourmenu=off#<CR>
	Read	Source Menu Status	<CR>*sourmenu=?#<CR>
	Write	3D Sync Off	<CR>*3d=off#<CR>
	Write	3D Auto	<CR>*3d=auto#<CR>
	Write	3D Sync Top Bottom	<CR>*3d=tb#<CR>
	Write	3D Sync Frame Sequential	<CR>*3d=fs#<CR>
	Write	3D Frame packing	<CR>*3d=fp#<CR>
	Write	3D Side by side	<CR>*3d=sbs#<CR>
	Write	3D inverter disable	<CR>*3d=da#<CR>
	Write	3D inverter	<CR>*3d=iv#<CR>
	Write	3D nVIDIA	<CR>*3d=nvidia#<CR>
	Read	3D Sync Status	<CR>*3d=?#<CR>
	Write	Remote Receiver - front+rear	<CR>*rr=fr#<CR>
Write	Remote Receiver - front	<CR>*rr=f#<CR>	
Write	Remote Receiver - rear	<CR>*rr=r#<CR>	
Read	Remote Receiver Status	<CR>*rr=?#<CR>	

Function	Type	Operation	ASCII
Miscellaneous	Write	AMX Device Discovery - on	<CR>*amxdd=on#<CR>
	Write	AMX Device Discovery - off	<CR>*amxdd=off#<CR>
	Read	AMX Device Discovery Status	<CR>*amxdd=?#<CR>
	Read	Mac Address	<CR>*macaddr=?#<CR>
	Write	High Altitude mode on	<CR>*Highaltitude=on#<CR>
	Write	High Altitude mode off	<CR>*Highaltitude=off#<CR>
	Read	High Altitude mode status	<CR>*Highaltitude=?#<CR>
Color Calibration	Write	Tint +	<CR>*tint=+#<CR>
	Write	Tint -	<CR>*tint=-#<CR>
	Write	Set Tint value	<CR>*tint=value#<CR>
	Read	Get Tint value	<CR>*tint=?#<CR>
	Write	Set gamma value	<CR>*gamma=value#<CR>
	Read	Gamma value status	<CR>*gamma=?#<CR>
	Write	Set HDR Brightness value	<CR>*hdrbri=value#<CR>
	Read	Get HDR Brightness value	<CR>*hdbri=?#<CR>
	Write	Red Gain +	<CR>*RGain=+#<CR>
	Write	Red Gain -	<CR>*RGain=-#<CR>
	Write	Set Red Gain value	<CR>*RGain=value#<CR>
	Read	Get Red Gain value	<CR>*RGain=?#<CR>
	Write	Green Gain +	<CR>*GGain=+#<CR>
	Write	Green Gain -	<CR>*GGain=-#<CR>
	Write	Set Green Gain value	<CR>*GGain=value#<CR>
	Read	Get Green Gain value	<CR>*GGain=?#<CR>
	Write	Blue Gain +	<CR>*BGain=+#<CR>
	Write	Blue Gain -	<CR>*BGain=-#<CR>
	Write	Set Blue Gain value	<CR>*BGain=value#<CR>
	Read	Get Blue Gain value	<CR>*BGain=?#<CR>
	Write	Red Offset +	<CR>*ROffset=+#<CR>
	Write	Red Offset -	<CR>*ROffset=-#<CR>
	Write	Set Red Offset value	<CR>*ROffset=value#<CR>
	Read	Get Red Offset value	<CR>*ROffset=?#<CR>
	Write	Green Offset +	<CR>*GOffset=+#<CR>
	Write	Green Offset -	<CR>*GOffset=-#<CR>
	Write	Set Green Offset value	<CR>*GOffset=value#<CR>
	Read	Get Green Offset value	<CR>*GOffset=?#<CR>

Function	Type	Operation	ASCII
Color Calibration	Write	Blue Offset +	<CR>*BOffset=+#<CR>
	Write	Blue Offset -	<CR>*BOffset=-#<CR>
	Write	Set Blue Offset value	<CR>*BOffset=value#<CR>
	Read	Get Blue Offset value	<CR>*BOffset=?#<CR>
	Write	Primary Color	<CR>*primcr=value#<CR>
	Read	Primary Color Status	<CR>*primcr=?#<CR>
	Write	Hue +	<CR>*hue=+#<CR>
	Write	Hue -	<CR>*hue=-#<CR>
	Write	Set Hue value	<CR>*hue=value#<CR>
	Read	Get Hue value	<CR>*hue=?#<CR>
	Write	Saturation +	<CR>*saturation=+#<CR>
	Write	Saturation -	<CR>*saturation=-#<CR>
	Write	Set Saturation value	<CR>*saturation=value#<CR>
	Read	Get Saturation value	<CR>*saturation=?#<CR>
	Write	Gain +	<CR>*gain=+#<CR>
	Write	Gain -	<CR>*gain=-#<CR>
	Write	Set Gain value	<CR>*gain=value#<CR>
	Read	Get Gain value	<CR>*gain=?#<CR>
Service	Read	Error Code report	<CR>*error=report#<CR>
	Read	FAN 1 speed	<CR>*fan1=?#<CR>
	Read	FAN 2 speed	<CR>*fan2=?#<CR>
	Read	FAN 3 speed	<CR>*fan3=?#<CR>
	Read	FAN 4 speed	<CR>*fan4=?#<CR>
	Read	FAN 5 speed	<CR>*fan5=?#<CR>
	Read	FAN 6 speed	<CR>*fan6=?#<CR>
	Read	FAN 7 speed	<CR>*fan7=?#<CR>
	Read	FAN 8 speed	<CR>*fan8=?#<CR>
	Read	FAN 9 speed	<CR>*fan9=?#<CR>
	Read	FAN 10 speed	<CR>*fan10=?#<CR>
	Read	Temperature 1	<CR>*tmp1=?#<CR>
	Read	Temperature 2	<CR>*tmp2=?#<CR>
	Read	Temperature 3	<CR>*tmp3=?#<CR>
	Read	Temperature 4	<CR>*tmp4=?#<CR>
	Read	Temperature 5	<CR>*tmp5=?#<CR>
	Read	LED indicator	<CR>*led=?#<CR>

PJLink

PJLink protocol

The network function of this projector support the PJLink class I, and the PJLink protocol can be used to perform projector setting and projector status query operations from a computer.

Control commands

The following table lists the PJLink protocol commands that can be used to control the projector.

- x characters in table are non-specific characters.

Command	Control Details	Parameter/ Return String	Remark		
POWR	Power supply control	0	Standby		
		1	Power on		
POWR?	Power supply status query	0	Standby		
		1	Power on		
INPT	Input selection	11	PC1 / YPbPr1		
INPT?	Input status query	12	PC2 / YPbPr2		
		21	VIDEO		
		31	HDMI1		
		32	HDMI2		
		33	DVI-D		
		34	HDBaseT		
AVMT	Mute	11	Video mute On		
AVMT?	Mute query	10	Video mute Off		
		21	Audio mute On		
		20	Audio mute Off		
		31	Video & Audio mute On		
		30	Video & Audio mute Off		
ERST?	Error status query	xxxxxx	1st byte	Indicates fan errors, and returns 0 - 2	0 = No error is detected 1 = Warning 2 = Error
			2nd byte	Indicates light source errors, and returns 0 - 2	
			3rd byte	Indicates temperature errors, and returns 0 - 2	
			4th byte	Return 0	
			5th byte	Return 0	
			6th byte	Indicates other errors, and returns 0 - 2	
LAMP?	Light source status query	xxxxxxxxxxxx	1st number (1-5 digitals): Light source 1 runtime		

Command	Control Details	Parameter/ Return String	Remark
INST?	Input selection list query	11 12 21 31 32 33 34	LU960UST
NAME?	Projector name query	xxxxx	Returns the name set in [PROJECTOR NAME] of [NETWORK SETUP]
INFI?	Manufacturer name query	BenQ	Returns manufacturer name
INF2?	Model name query	LU960UST	Returns model name
INF0?	Other information queries	xxxxx	Returns information such as version number
CLASS?	Class information query	I	Returns class for PJLink