

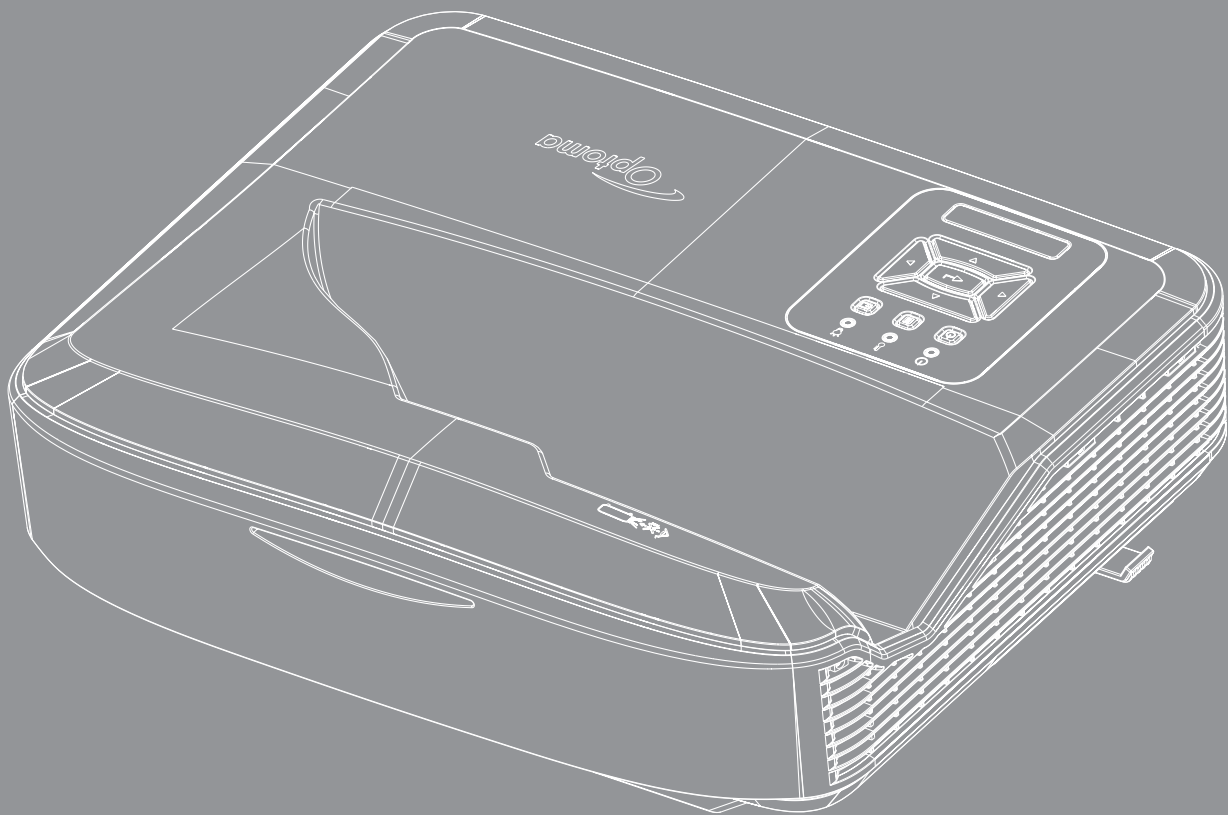

DLP® Projector



User's Manual



TABLE OF CONTENTS



SAFETY	4
<i>Important Safety Instructions.....</i>	<i>4</i>
<i>Cleaning the Lens.....</i>	<i>5</i>
<i>Laser Radiation Safety Information</i>	<i>6</i>
<i>Copyright.....</i>	<i>7</i>
<i>Disclaimer.....</i>	<i>7</i>
<i>Trademark Recognition</i>	<i>7</i>
<i>FCC</i>	<i>7</i>
<i>Declaration of Conformity for EU countries</i>	<i>8</i>
<i>WEEE.....</i>	<i>8</i>
INTRODUCTION.....	9
<i>Product Overview</i>	<i>10</i>
<i>Connections.....</i>	<i>11</i>
<i>Remote Control</i>	<i>13</i>
SETUP AND INSTALLATION.....	14
<i>Installing the projector</i>	<i>14</i>
<i>Connecting sources to the projector.....</i>	<i>16</i>
<i>Adjusting the projector image</i>	<i>17</i>
<i>Adjusting the projector focus</i>	<i>18</i>
<i>Remote setup</i>	<i>19</i>
USING THE PROJECTOR.....	21
<i>Powering on / off the projector.....</i>	<i>21</i>
<i>Selecting an input source</i>	<i>22</i>
<i>Menu navigation and features</i>	<i>23</i>
<i>OSD Menu tree.....</i>	<i>24</i>
<i>Display image settings menu.....</i>	<i>34</i>
<i>Display enhanced gaming menu</i>	<i>36</i>
<i>Display 3D menu</i>	<i>37</i>
<i>Display aspect ratio menu</i>	<i>38</i>
<i>Display edge mask menu</i>	<i>40</i>
<i>Display zoom menu.....</i>	<i>40</i>
<i>Display digital lens shift menu</i>	<i>40</i>
<i>Display image shift menu</i>	<i>40</i>
<i>Display geometric correction menu</i>	<i>40</i>
<i>Display reset menu.....</i>	<i>40</i>

- Audio audio settings menu* 41
- Audio mute menu* 41
- Audio mic menu*..... 41
- Audio volume menu*..... 41
- Audio mic volume menu* 41
- Setup projection menu*..... 42
- Setup screen type menu*..... 42
- Setup filter settings menu* 42
- Setup power settings menu* 43
- Setup security menu*..... 43
- Setup HDMI link settings menu* 44
- Setup test pattern menu* 44
- Setup remote settings menu*..... 44
- Setup projector ID menu*..... 45
- Setup options menu*..... 45
- Setup reset OSD menu* 47
- Network LAN menu* 47
- Network control menu*..... 48
- Setup network control settings menu* 49
- Info menu*..... 54

ADDITIONAL INFORMATION 55

- Compatible resolutions*..... 55
- RS232 Port Setting and Signals Connection*..... 60
- Adjusting Projection Image Size (Diagonal)* 61
- Projector dimensions and ceiling mount installation*..... 63
- IR remote codes*..... 64
- Troubleshooting*..... 66
- Warning indicators*..... 68
- Specifications* 69
- RS232 protocol function list*..... 70

SAFETY

	The lightning flash with arrow head within an equilateral triangle is intended to alert the user to the presence of uninsulated “dangerous voltage” within the product’s enclosure that may be of sufficient magnitude to constitute a risk of electric shock to persons.
	The exclamation point within an equilateral triangle is intended to alert the user to the presence of important operating and maintenance (servicing) instructions in the literature accompanying the appliance.

Please follow all warnings, precautions and maintenance as recommended in this user’s guide.

Important Safety Instructions



- Do not stare into the beam, RG2.
As with any bright source, do not stare into the direct beam, RG2 IEC 62471-5:2015.
- This projector is class 1 laser product of IEC 60825-1:2014 and risk group 2 with the requirements of IEC 62471-5:2015.
- Notice is given to supervise children and to never allow them to stare into the projector beam at any distance from the projector.
- Notice is given to use caution when using the remote control for starting the projector while in front of the projection lens.
- Notice is given to the user to avoid the use of optical aids such as binoculars or telescopes inside the beam.
- Do not block any ventilation openings. To ensure reliable operation of the projector and to protect from overheating, it is recommended to install the projector in a location that does not block ventilation. As an example, do not place the projector on a crowded surface. Do not put the projector in an enclosure such as a book case or a cabinet that restricts air flow.
- To reduce the risk of fire and/or electric shock, do not expose the projector to rain or moisture. Do not install near heat sources such as radiators, heaters, stoves or any other apparatus such as amplifiers that emits heat.
- Do not let objects or liquids enter the projector. They may touch dangerous voltage points and short out parts that could result in fire or electric shock.
- Do not use under the following conditions:
 - In extremely hot, cold or humid environments.
 - (i) Ensure that the ambient room temperature is within 5°C ~ 40°C (41°F ~ 104°F)
 - (ii) Relative humidity is 10% ~ 85%
 - In areas susceptible to excessive dust and dirt.
 - Near any appliance generating a strong magnetic field.
 - In direct sunlight.
- Do not use the unit if it has been physically damaged or abused. Physical damage/abuse would be (but not limited to):
 - Unit has been dropped.
 - Power supply cord or plug has been damaged.
 - Liquid has been spilled on to the projector.
 - Projector has been exposed to rain or moisture.
 - Something has fallen in the projector or something is loose inside.
- Do not place the projector on an unstable surface. The projector may fall over resulting in injury or the projector may become damaged.

SAFETY

- Do not block the light coming out of the projector lens when in operation. The light will heat the object and cause it to melt, burn or start a fire.
- Please do not open or disassemble the projector as this may cause electric shock.
- See projector enclosure for safety related markings.
- The unit should only be repaired by authorized service personnel.
- Only use attachments/accessories specified by the manufacturer.
- Do not look straight into the projector lens during operation. The bright light may harm your eyes.
- This projector will detect the life of the light source itself.
- Turn off and unplug the power plug from the AC outlet before cleaning the product.
- Use a soft dry cloth with mild detergent to clean the display housing. Do not use abrasive cleaners, waxes or solvents to clean the unit.
- Disconnect the power plug from the AC outlet if the product will not be used for a long period of time.
- Do not setup the projector in places where it might be subjected to vibration or shock.
- Do not touch the lens with bare hands.
- Remove battery/batteries from remote control before storage. If the battery/batteries are left in the remote for long periods, they may leak.
- Do not use or store the projector in places where smoke from oil or cigarettes may be present, as it can adversely affect the quality of the projector performance.
- Please follow the correct projector orientation installation as non standard installation may affect the projector performance.
- Use a power strip and/or surge protector. As power outages and brown-outs can KILL devices.

Cleaning the Lens

- Before cleaning the lens, be sure to turn off the projector and unplug the power cord to allow it to completely cool down.
- Use a compressed air tank to remove the dust.
- Use a special cloth for cleaning lens and gently wipe the lens. Do not touch the lens with your fingers.
- Do not use alkaline/acid detergents or volatile solvents such as alcohol for cleaning lens. If the lens is damaged due to the cleaning process, it is not covered by the warranty.



Warning: Do not use a spray containing flammable gases to remove dust or dirt from the lens. This may cause a fire due to excessive heat inside the projector.



Warning: Do not clean the lens if the projector is warming up as this may cause the lens' surface film to peel off.



Warning: Do not wipe or tap the lens with a hard object.

To avoid electric shock, the unit and its peripherals must be properly grounded (earthed).

This equipment is equipped with a three-pin grounding-type power plug. Do not remove the grounding pin on the power plug. This is a safety feature. If you are unable to insert the plug into the outlet, contact an electrician. Do not defeat the purpose of the grounding plug.

SAFETY

Laser Radiation Safety Information

- This product is classified as CLASS 1 LASER PRODUCT - RISK GROUP 2 of IEC60825-1 : 2014 and also complies with 21 CFR 1040.10 and 1040.11 as a Risk Group 2, LIP (Laser Illuminated Projector) as defined in IEC 62471-5:Ed. 1.0. For more information see Laser Notice No. 57, dated May 8, 2019.
- As with any bright source, do not stare into the direct beam, RG2 IEC 62471-5:2015

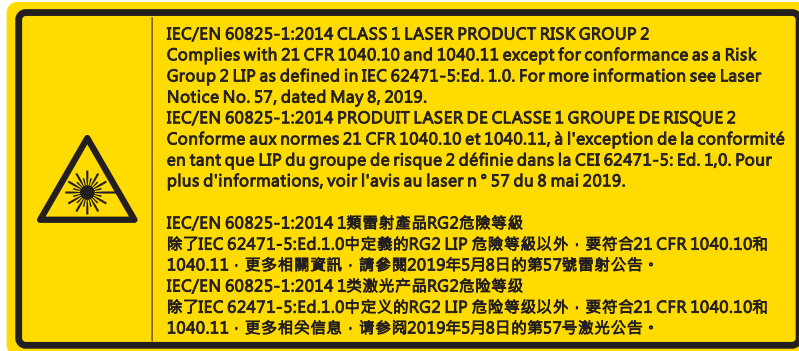

- When turning on the projector, make sure no one within projection range is looking at the lens.
- Keep any items (magnifying glass etc.) out of the light path of the projector. The light path being projected from the lens is extensive, therefore any kind of abnormal objects that can redirect light coming out of the lens, can cause an unpredictable outcome such as a fire or injury to the eyes.
- Any operation or adjustment not specifically instructed by the user's guide creates the risk of hazardous laser radiation exposure.
- Do not open or disassemble the projector as this may cause damage by the exposure of laser radiation.
- Do not stare into beam when the projector is on. The bright light may result in permanent eye damage.

Without following the control, adjustment or operation procedure may cause damage by the exposure of laser radiation

SAFETY

Copyright

This publication, including all photographs, illustrations and software, is protected under international copyright laws, with all rights reserved. Neither this manual, nor any of the material contained herein, may be reproduced without written consent of the author.

© Copyright 2021

Disclaimer

The information in this document is subject to change without notice. The manufacturer makes no representations or warranties with respect to the contents hereof and specifically disclaims any implied warranties of merchantability or fitness for any particular purpose. The manufacturer reserves the right to revise this publication and to make changes from time to time in the content hereof without obligation of the manufacturer to notify any person of such revision or changes.

Trademark Recognition

Kensington is a U.S. registered trademark of ACCO Brand Corporation with issued registrations and pending applications in other countries throughout the world.

HDMI, the HDMI Logo, and High-Definition Multimedia Interface are trademarks or registered trademarks of HDMI Licensing LLC in the United States and other countries.

DLP®, DLP Link and the DLP logo are registered trademarks of Texas Instruments and BrilliantColor™ is a trademark of Texas Instruments.

All other product names used in this manual are the properties of their respective owners and are Acknowledged.

FCC

This device has been tested and found to comply with the limits for a Class B digital device pursuant to Part 15 of the FCC rules. These limits are designed to provide reasonable protection against harmful interference in a residential installation. This device generates, uses and can radiate radio frequency energy and, if not installed and used in accordance with the instructions, may cause harmful interference to radio communications.

However, there is no guarantee that interference will not occur in a particular installation. If this device does cause harmful interference to radio or television reception, which can be determined by turning the device off and on is encouraged to try to correct the interference by one or more of the following measures:

- Reorient or relocate the receiving antenna.
- Increase the separation between the device and receiver.
- Connect the device into an outlet on a circuit different from that to which the receiver is connected.
- Consult the dealer or an experienced radio/television technician for help.

Notice: Shielded cables

All connections to other computing devices must be made using shielded cables to maintain compliance with FCC regulations.

Caution

Changes or modifications not expressly approved by the manufacturer could void the user's authority, which is granted by the Federal Communications Commission, to operate this projector.

Operation Conditions

This device complies with Part 15 of the FCC Rules. Operation is subject to the following two conditions:

1. This device may not cause harmful interference and
2. This device must accept any interference received, including interference that may cause undesired operation.

SAFETY

This Equipment has been tested and found to comply with the limits for a Class B digital device, pursuant to part 15 of the FCC Rules. These limits are designed to provide reasonable protection against harmful interference when the equipment is operated in a commercial environment. This equipment generates, uses, and can radiate radio frequency energy and, if not installed and used in accordance with the instruction manual, may cause harmful interference to radio communications.

Operation of this equipment in a residential area is likely to cause harmful interference in which case the user will be required to correct the interference at his own expense.

Notice: Canadian users

This Class B digital apparatus complies with Canadian ICES-003.

Remarque à l'intention des utilisateurs canadiens

Cet appareil numérique de la classe B est conforme à la norme NMB-003 du Canada.

Declaration of Conformity for EU countries

- EMC Directive 2014/30/EU (including amendments)
- Low Voltage Directive 2014/35/EU
- R & TTE Directive Directive 2014/53/EU (if product has RF function)

WEEE



Disposal instructions

Do not throw this electronic device into the trash when discarding. To minimize pollution and ensure utmost protection of the global environment, please recycle it.

CAUTION: This equipment is equipped with a three-pin grounding-type power plug. Do not remove the grounding pin on the power plug. This plug will only fit a grounding type power outlet. This is a safety feature. If you are unable to insert the plug into the outlet, contact an electrician. Do not defeat the purpose of the grounding plug.

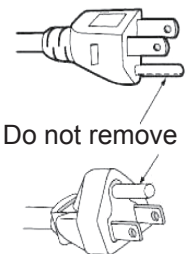

Warning: Do not remove the earthing pin on the mains plugs. This apparatus is equipped with a three prong earthing type mains plug. This plug will only fit an earthing-type mains socket. This is a safety feature. If you are unable to insert the plug into the mains socket, contact an electrician. Do not defeat the purpose of the earthing plug.

INTRODUCTION

Package Overview

Carefully unpack and verify that you have the items listed below under standard accessories. Some of the items under optional accessories may not be available depending on the model, specification and your region of purchase. Please check with your place of purchase. Some accessories may vary from region to region.

The warranty card is only supplied in some specific regions. Please consult your dealer for detailed information.

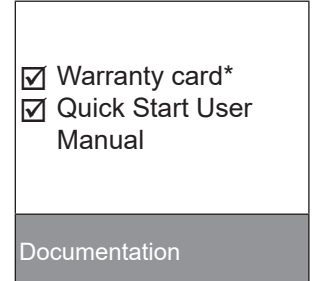
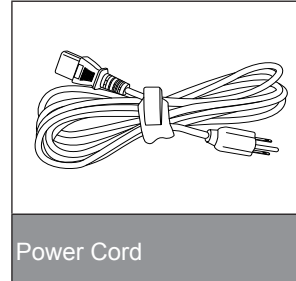
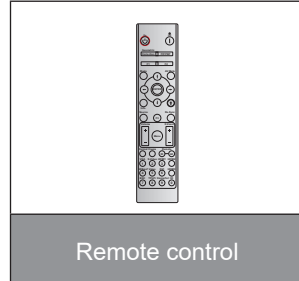

Note:

- *The remote control is shipped with the battery.*
- **For European warranty Information, please visit www.optoma.com.*



*Please scan the OPAM warranty QR code or visit the following URL:
<https://www.optoma.com/us/support/warranty-and-return-policy/>*



Please scan the Asia-Pacific QR code or visit the following URL: <https://www.optoma.com/support/download>

INTRODUCTION

Product Overview

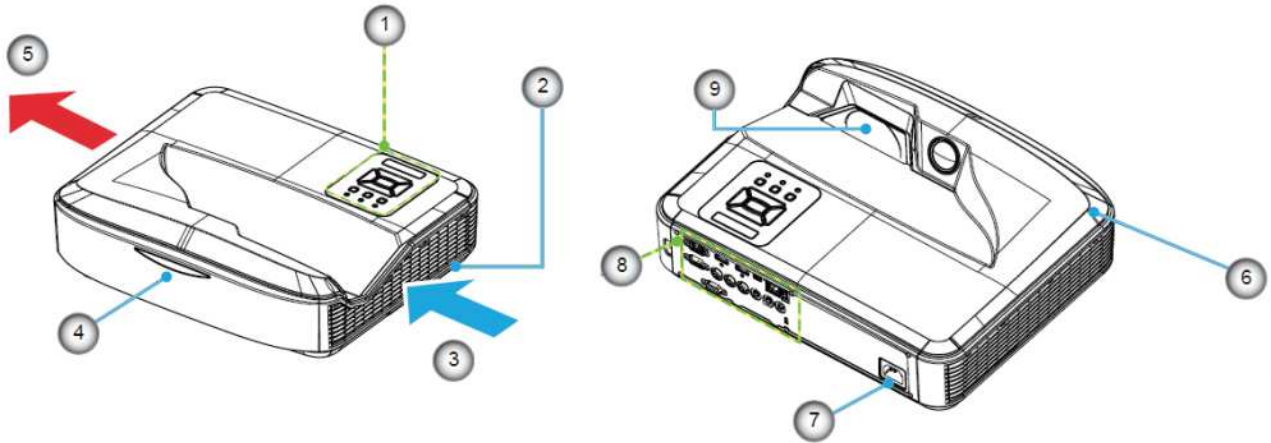

Note:

- Do not block projector intake and exhaust vents.
- When operating the projector in an enclosed space, allow at least 30 cm clearance around the intake and exhaust vents.

No	Item
1.	Control Panel
2.	Focus Switch
3.	Ventilation (inlet)
4.	IR Receiver
5.	Ventilation (outlet)

No	Item
6.	Speaker
7.	Power Socket
8.	Input / Output
9.	Lens

INTRODUCTION

Connections

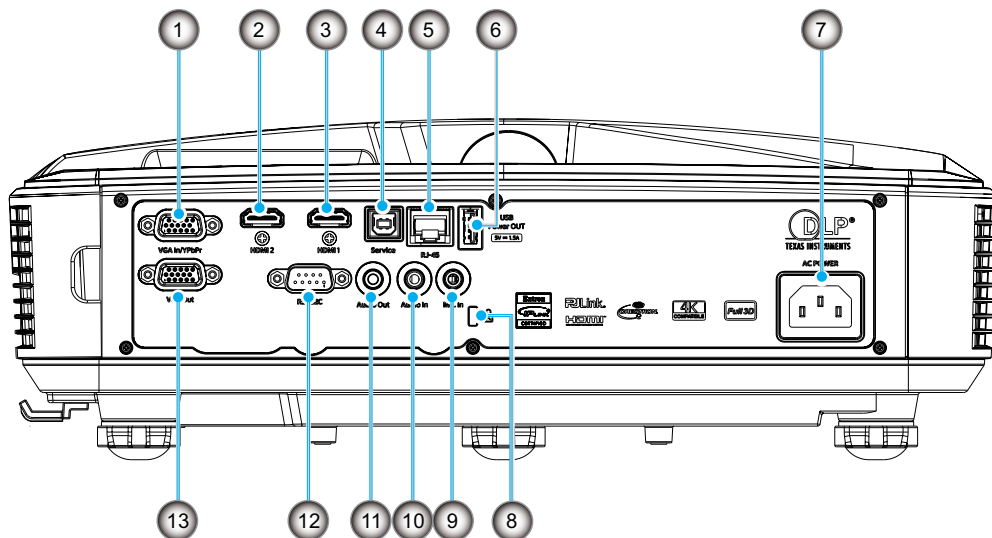

No	Item
1.	VGA In / YPbPr Connector
2.	HDMI 2 Connector
3.	HDMI 1 Connector
4.	USB Type B Connector
5.	RJ45 Connector
6.	USB Power Out (5V/1.5A) Connector

No	Item
7.	Power Socket
8.	Kensington™ Lock Port
9.	MIC In Connector
10.	Audio In Connector
11.	Audio Out Connector
12.	RS232 Connector
13.	VGA Out Connector

INTRODUCTION

Control Panel

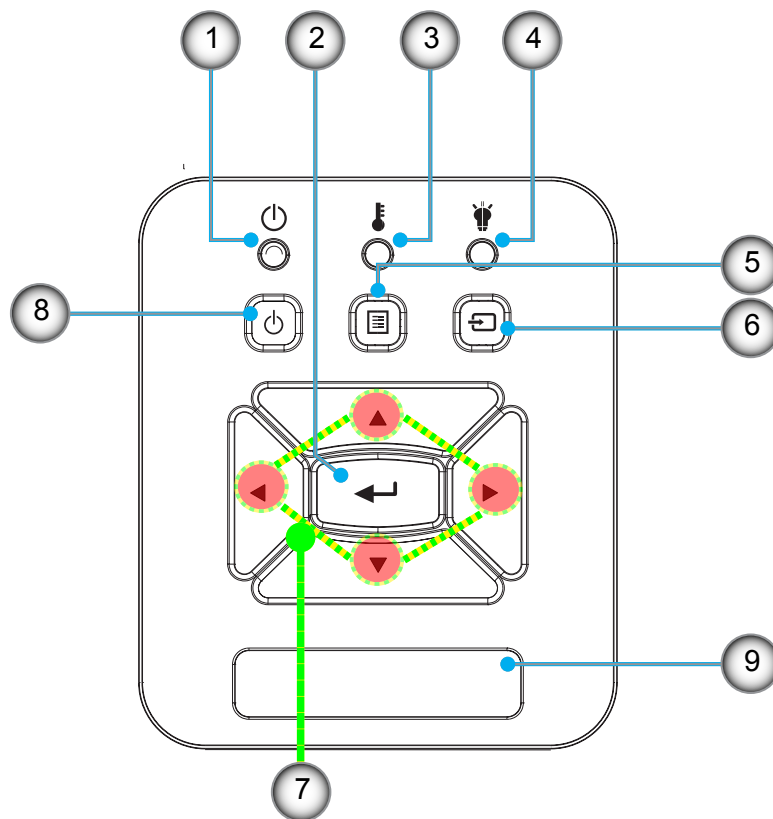

No	Item
1.	Power LED
2.	Enter
3.	Temp LED
4.	Lamp LED
5.	Menu

No	Item
6.	Input
7.	Four Directional Select Keys
8.	Power/Standby Button
9.	IR Receiver

INTRODUCTION

Remote Control

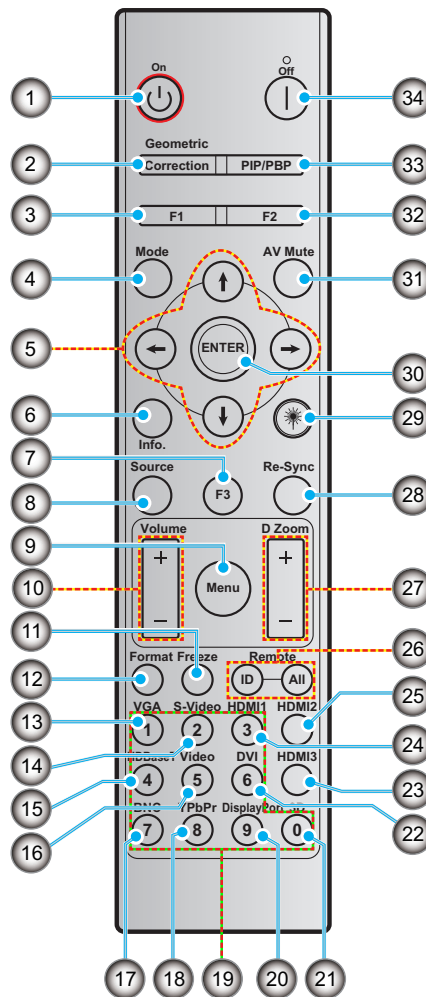

No	Item
1.	Power on
2.	Geometric Correction
3.	Function button (F1) (Assignable)
4.	Mode
5.	Four directional select keys
6.	Information
7.	Function button (F3) (Assignable)
8.	Source
9.	Menu
10.	Volume - / +
11.	Freeze
12.	Format (Aspect Ratio)
13.	VGA
14.	S-Video (not supported)
15.	HDBase-T (not supported)
16.	Video
17.	BNC (not supported)

No	Item
18.	YPbPr (not supported)
19.	Numeric keypad (0-9)
20.	Display port (not supported)
21.	3D
22.	DVI (not supported)
23.	HDMI3 (not supported)
24.	HDMI1
25.	HDMI2
26.	Remote ID / Remote all
27.	Digital Zoom - / +
28.	Re-sync
29.	Laser
30.	Enter
31.	AV Mute
32.	Function button (F2) (Assignable)
33.	PIP/PBP (not supported)
34.	Power off

Note:

- Some keys may have no function for models that do not support these features.
- Does not support Wired IR function.

SETUP AND INSTALLATION

Installing the projector

Your projector is designed to be installed in one of four possible positions.

Your room layout or personal preference will dictate which installation location you select. Take into consideration the size and position of your screen, the location of a suitable power outlet, as well as the location and distance between the projector and the rest of your equipment.

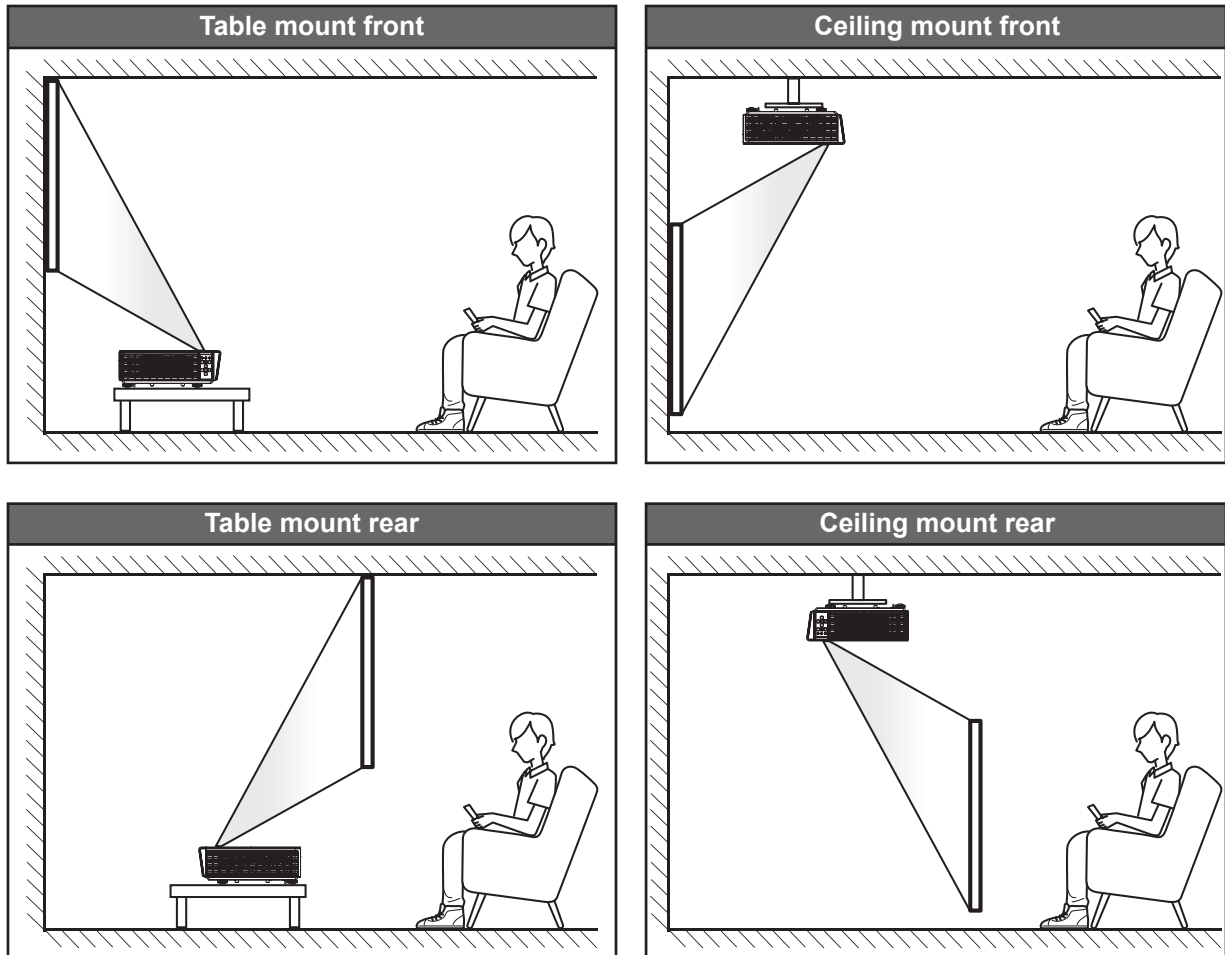

Projector should be placed flat on a surface and 90 degrees / perpendicular to the screen.

- How to determine projector location for a given screen size, please refer to distance table on page 61.
- How to determine screen size for a given distance, please refer to distance table on page 61.

Note: *The further away the projector is placed from the screen the projected image size increases and vertical offset also increases proportionally.*

SETUP AND INSTALLATION

Projector installation notice

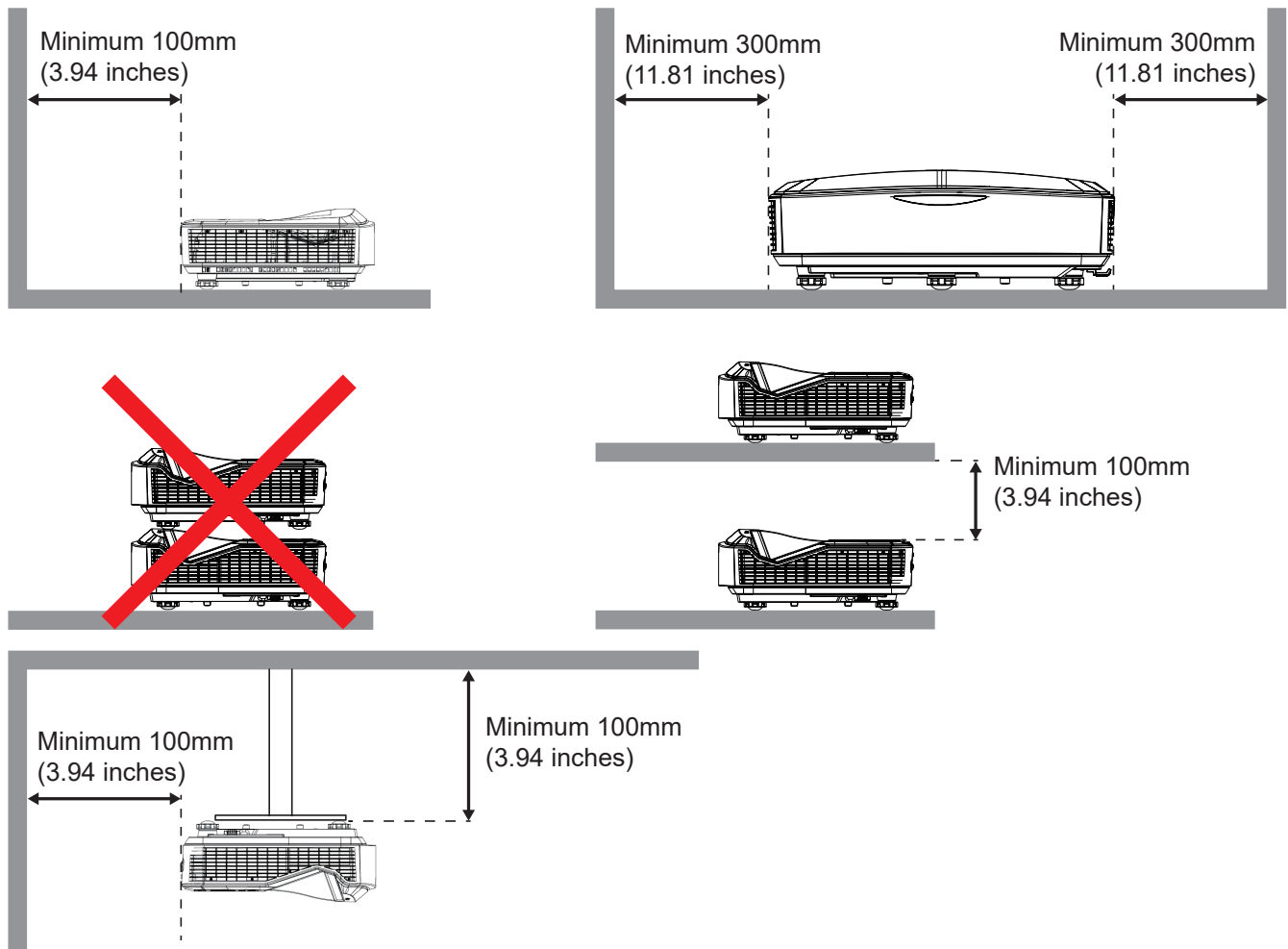

- Ensure that the intake vents do not recycle hot air from the exhaust vent.
- When operating the projector in an enclosed space, ensure that the surrounding air temperature within the enclosure does not exceed operation temperature while the projector is running, and the air intake and exhaust vents are unobstructed.
- All enclosures should pass a certified thermal evaluation to ensure that the projector does not recycle exhaust air, as this may cause the device to shutdown even if the enclosure temperature is within the acceptable operation temperature range.

Note:

- Supports front, ceiling, and downward projection.

SETUP AND INSTALLATION

Connecting sources to the projector

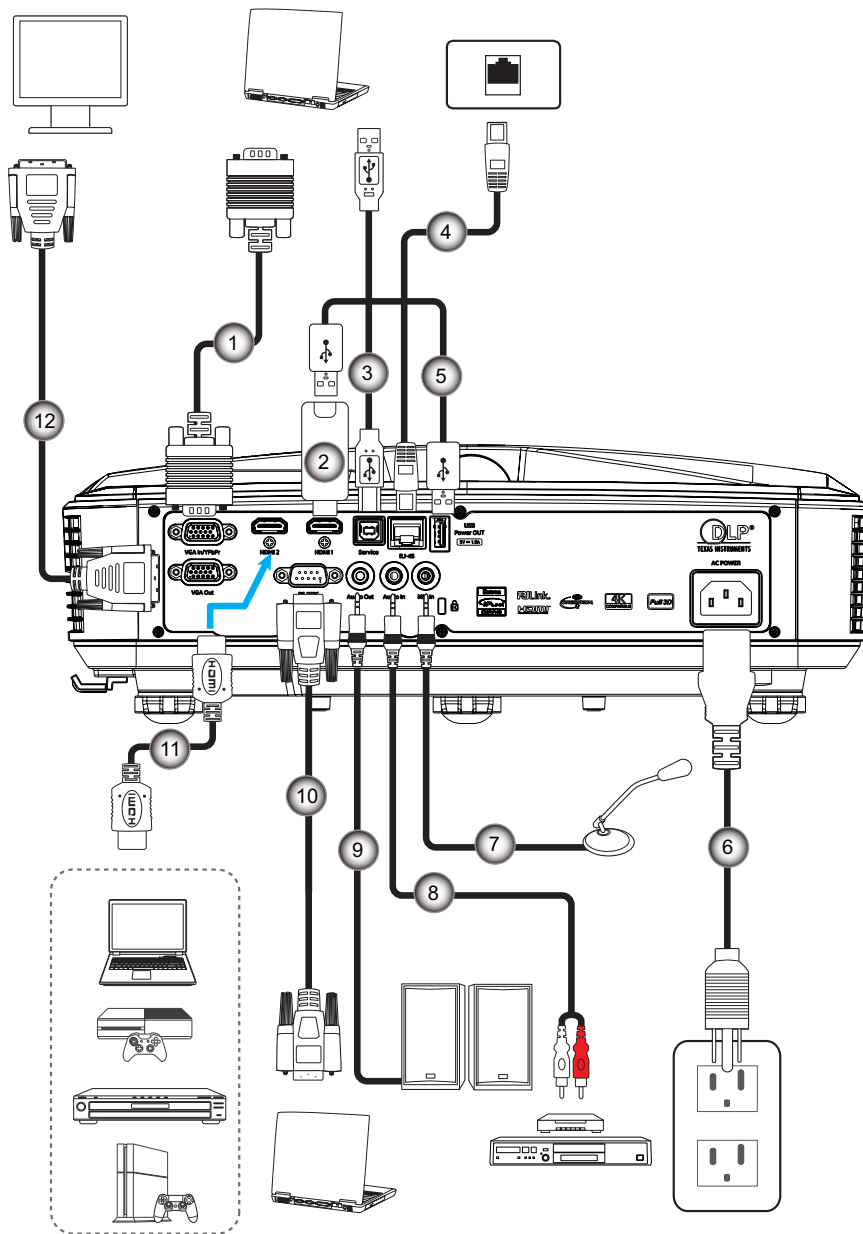

No	Item
1.	VGA Cable
2.	HDMI Dongle
3.	USB A to B Cable
4.	RJ45 Cable
5.	USB A to A Cable
6.	Power Cord

No	Item
7.	Microphone Cable
8.	Audio In Cable
9.	Audio Out Cable
10.	RS232 Cable
11.	HDMI Cable
12.	VGA Out Cable

SETUP AND INSTALLATION

Adjusting the projector image

Image height

The projector is equipped with elevator feet for adjusting the image height.

1. Locate the adjustable foot you wish to adjust on the underside of the projector.
2. Rotate the adjustable foot clockwise or counterclockwise to raise or lower the projector.

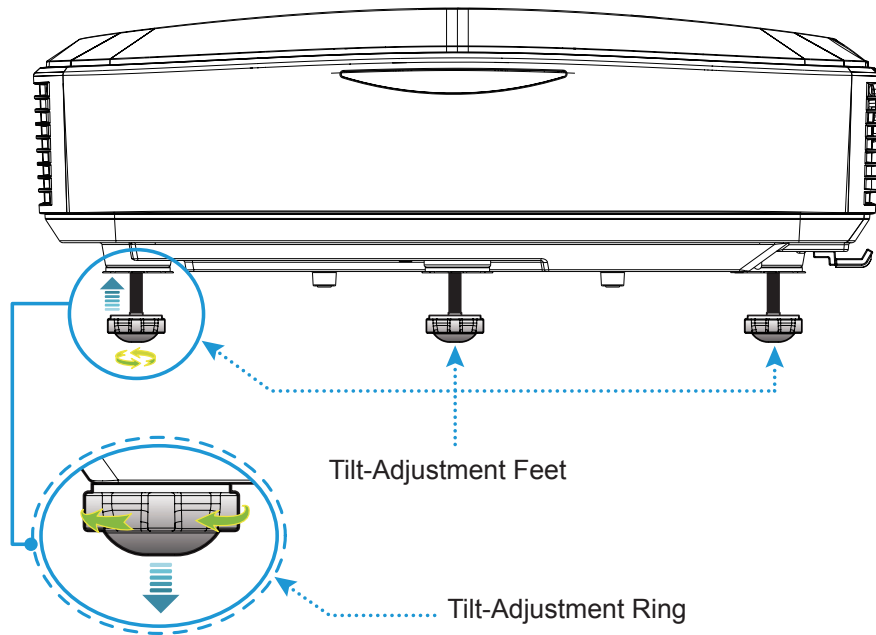

SETUP AND INSTALLATION

Adjusting the projector focus

To focus the image, slide the focus switch to left/right until the image is clear.

- The projector will focus at distances (Lens to wall) from 1.499 to 1.913 feet (0.457 to 0.583 meters).

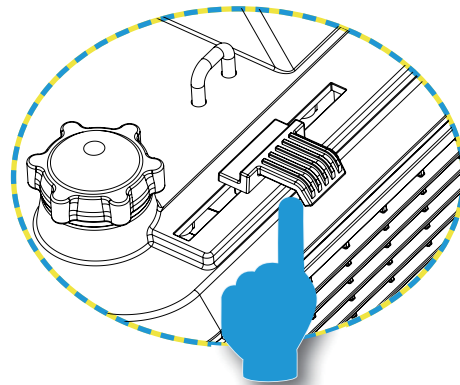

Focus Switch

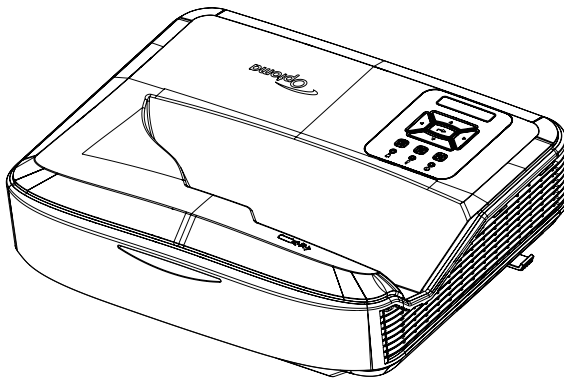

SETUP AND INSTALLATION

Remote setup

Installing / replacing the batteries

Two AAA size batteries are supplied for the remote control.

1. Remove the battery cover on the back of the remote control.
2. Insert AAA batteries in the battery compartment as illustrated.
3. Replace back cover on remote control.

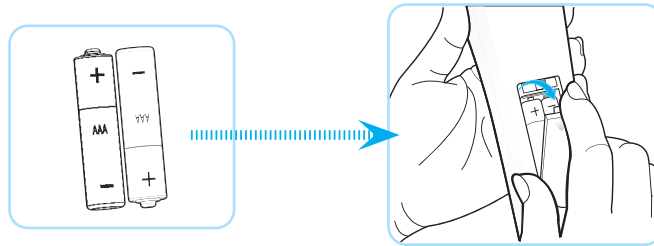

Note: Replace only with the same or equivalent type batteries.

CAUTION

Improper use of batteries can result in chemical leakage or explosion. Be sure to follow the instructions below.

- Do not mix batteries of different types. Different types of batteries have different characteristics.
- Do not mix old and new batteries. Mixing old and new batteries can shorten the life of new batteries or cause chemical leakage in old batteries.
- Remove batteries as soon as they are depleted. Chemicals that leak from batteries that come in contact with skin can cause a rash. If you find any chemical leakage, wipe thoroughly with a cloth.
- The batteries supplied with this product may have a shorter life expectancy due to storage conditions.
- If you will not be using the remote control for an extended period of time, remove the batteries.
- When you dispose of the batteries, you must obey the law in the relative area or country.

SETUP AND INSTALLATION

Effective range

Infra-Red (IR) remote control sensor is located on the top side of the projector. Ensure to hold the remote control at an angle within 60 degrees perpendicular to the projector's IR remote control sensor to function correctly. The distance between the remote control and the sensor should not be longer than 12 meters (39.4 feet).

- Make sure that there are no obstacles between the remote control and the IR sensor on the projector that might obstruct the infra-red beam.
- Make sure the IR transmitter of the remote control is not being shined by sunlight or fluorescent lamps directly.
- Please keep the remote controller away from fluorescent lamps for over 2 m or the remote controller might become malfunction.
- If the remote control is close to Inverter-Type fluorescent lamps, it might become ineffective from time to time.
- If the remote control and the projector are within a very short distance, the remote control might become ineffective.
- When you aim at the screen, the effective distance is less than 5 m from the remote control to the screen and reflecting the IR beams back to the projector. However, the effective range might change according to screens.

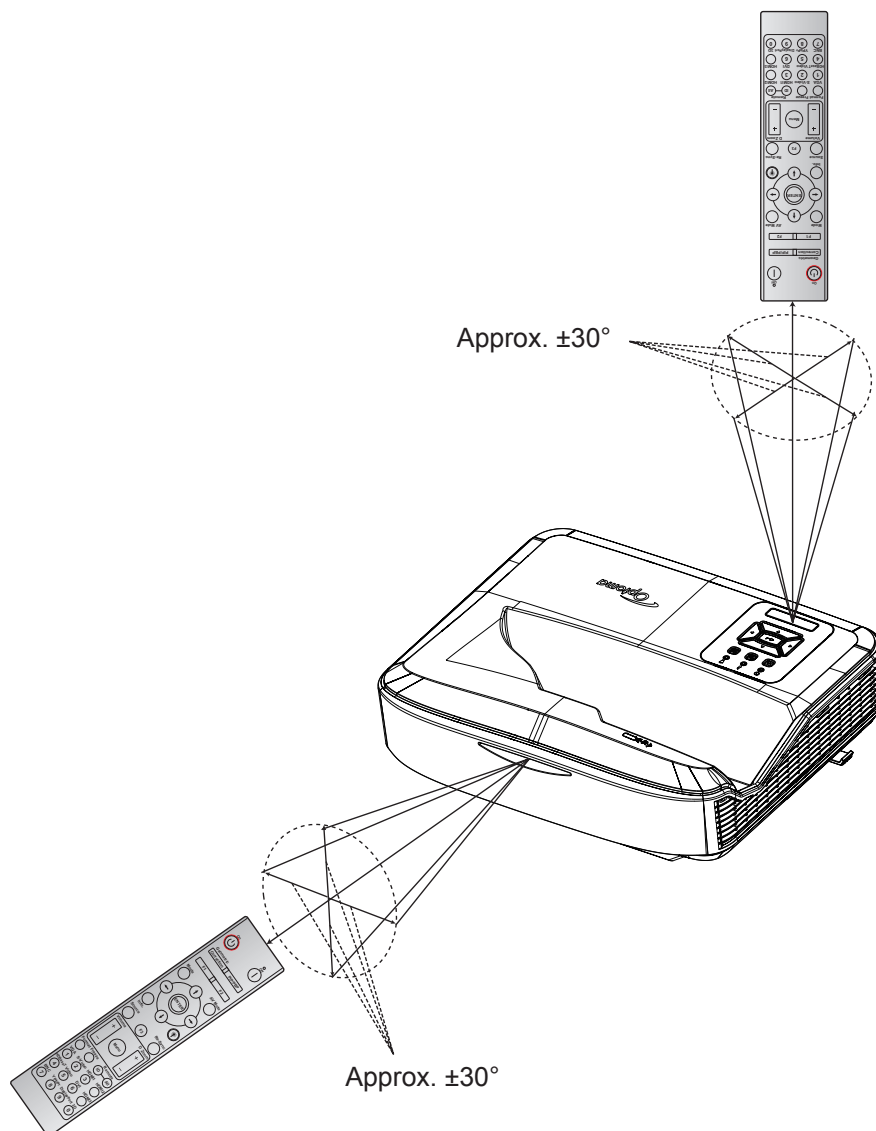

USING THE PROJECTOR

Powering on / off the projector

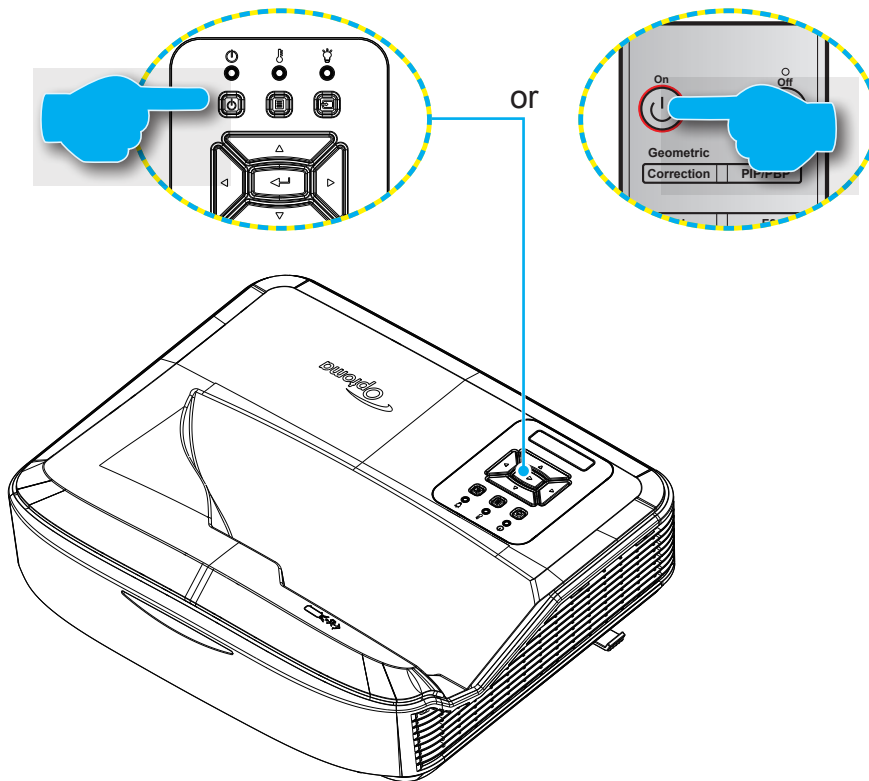



Powering on





1. Securely connect the power lead and signal/source cable. When connected, the Power LED will turn red.
2. Turn on the projector by pressing the  button on the projector keypad or remote control.
3. A start up screen will display in approximately 10 seconds and the Power LED will be flashing blue.

Note: The first time the projector is turned on, you will be prompted to select the preferred language, projection orientation, and other settings.

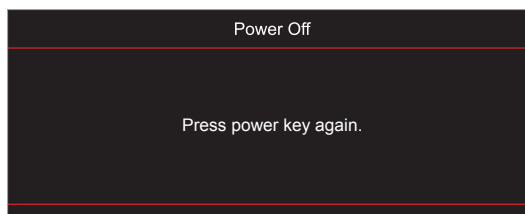
Powering off

1. Turn off the projector by pressing the  button on the projector keypad or the  button on the remote control.
2. The following message will be displayed:



3. Press the  or  button again to confirm, otherwise the message will disappear after 15 seconds. When you press the  or  button for the second time, the projector will shut down.
4. The cooling fans will continue to operate for about 10 seconds for the cooling cycle and the Power LED will flash blue. When the Power turns solid red, this indicates the projector has entered standby mode. If you wish to turn the projector back on, you must wait until the cooling cycle has finished and the projector has entered standby mode. When the projector is in standby mode, simply press the  button again to turn on the projector.
5. Disconnect the power lead from the electrical outlet and the projector.

Note: It is not recommended that the projector is turned on immediately, right after a power off procedure.

USING THE PROJECTOR

Selecting an input source

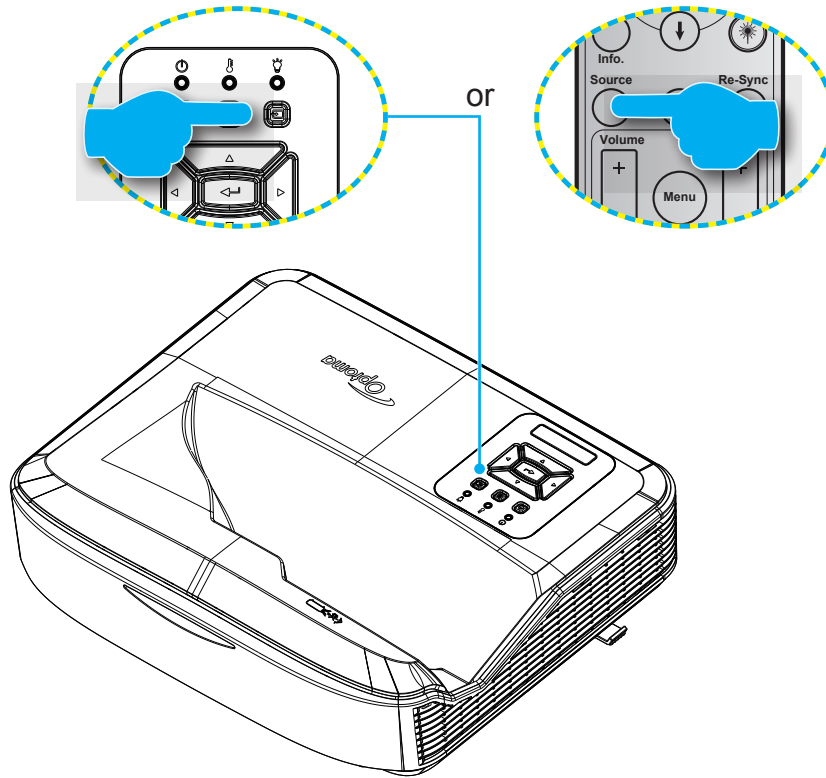

Turn on the connected source that you want to display on the screen, such as computer, notebook, video player, etc. The projector will automatically detect the source. If multiple sources are connected, press the  button on the projector keypad or the Source button on the remote control to select the desired input.



USING THE PROJECTOR

Menu navigation and features

The projector has multilingual on-screen display menus that allow you to make image adjustments and change a variety of settings. The projector will automatically detect the source.

1. To open the OSD menu, press the  button on the projector keypad or the **Menu** button on the remote control.
2. When OSD is displayed, use **▲▼** keys to select any item in the main menu. While making a selection on a particular page, press the **←** button on the projector keypad or the **Enter** button on the remote control to enter sub menu.
3. Use **▲▼** keys to select the desired item in the sub menu and then press the **←** or **Enter** button to view further settings. Adjust the settings by using **◀▶** keys.
4. Select the next item to be adjusted in the sub menu and adjust as described above.
5. Press the **←** or **Enter** button to confirm, and the screen will return to the main menu.
6. To exit, press the  or **Menu** button again. The OSD menu will close and the projector will automatically save the new settings.

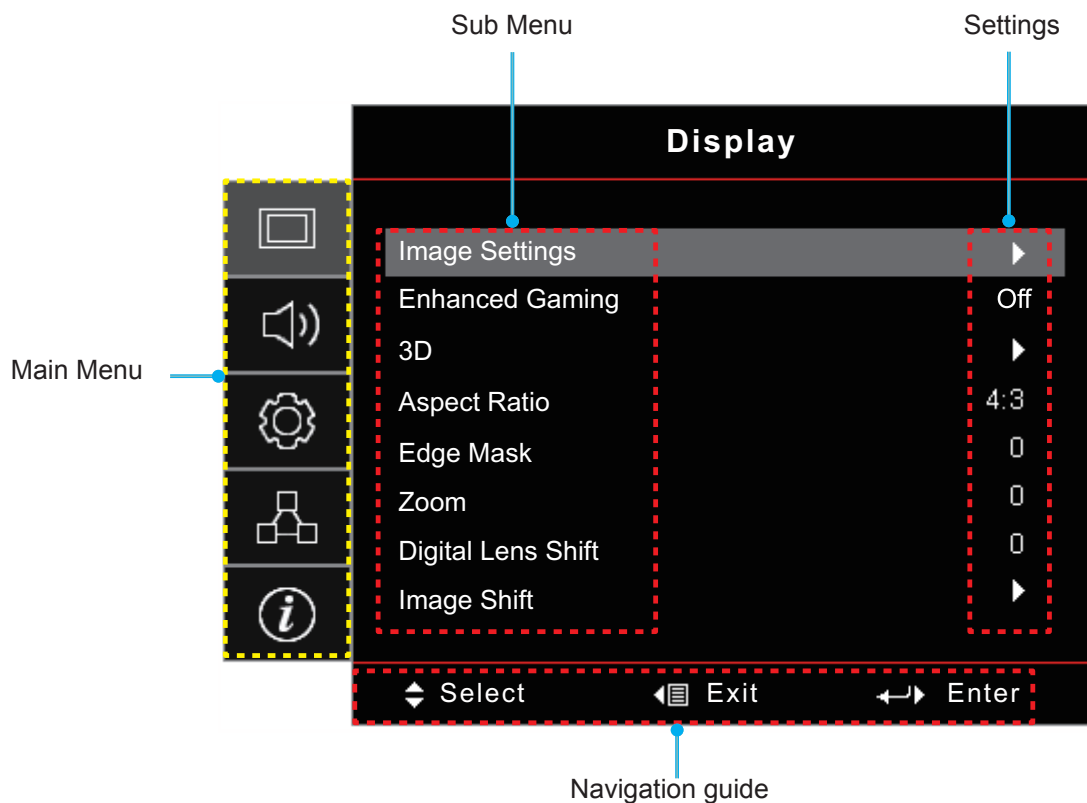

USING THE PROJECTOR

OSD Menu tree

Main Menu	Sub Menu	Sub Menu 2	Sub Menu 3	Sub Menu 4	Values		
Display	Image Settings	Display Mode			Presentation		
					Bright		
					HDR		
					HLG		
					Cinema		
					sRGB		
					DICOM SIM.		
					Blending		
					User		
				3D		Off [Default]	
			Wall Color			Blackboard	
						Light Yellow	
						Light Green	
						Light Blue	
						Pink	
						Gray	
			Dynamic Range	HDR/HLG			Off
							Auto [Default]
				HDR Picture Mode			Bright
							Standard [Default]
							Film
							Detail
				HLG Picture Mode			Bright
							Standard [Default]
							Film
						Detail	
				Brightness			-50 ~ 50
				Contrast			-50 ~ 50
				Sharpness			1 ~ 15
				Color			-50 ~ 50
				Tint			-50 ~ 50

USING THE PROJECTOR

Main Menu	Sub Menu	Sub Menu 2	Sub Menu 3	Sub Menu 4	Values	
Display	Image Settings	Gamma	Film			
			Video			
			Graphics			
			Standard(2.2)			
			1.8			
			2.0			
			2.4			
			2.6			
		Color Settings	BrilliantColor™			1 ~ 10
			Color Temperature			Warm
						Standard
						Cool
						Cold
			Color Matching	Color		R [Default]
						G
						B
						C
						Y
						M
						W
					Hue	-50 ~ 50 [Default: 0]
					Saturation	-50 ~ 50 [Default: 0]
					Gain	-50 ~ 50 [Default: 0]
			RGB Gain/Bias	Reset		Cancel [Default]
						Yes
				Exit		
				Red Gain		-50 ~ 50
				Green Gain		-50 ~ 50
				Blue Gain		-50 ~ 50
				Red Bias		-50 ~ 50
				Green Bias		-50 ~ 50
			Blue Bias		-50 ~ 50	
			Color Space [Not HDMI Input]	Reset		Cancel [Default]
						Yes
				Exit		
						Auto [Default]
					RGB	
					YUV	

USING THE PROJECTOR

Main Menu	Sub Menu	Sub Menu 2	Sub Menu 3	Sub Menu 4	Values
Display	Image Settings	Color Settings	Color Space [HDMI Input]		Auto [Default]
					RGB(0~255)
					RGB(16~235)
					YUV
		Signal	Automatic		Off
					On [Default]
				Frequency	-50 ~ 50 (depends on signal) [Default: 0]
				Phase	0~31 (depends on signal) [Default: 0]
				H. Position	-50 ~ 50 (depends on signal) [Default: 0]
		Brightness Mode	V. Position		-50 ~ 50 (depends on signal) [Default: 0]
				Dynamic Black	Off / On (0~70%)
				Eco.	
				Constant Power	100%~20%, 5% per step [Default: 100%]
		Reset	Constant Luminance		85%~30%, 5% per step
		Enhanced Gaming			On
					Off [Default]
		3D	3D Mode		Off
					On [Default]
	3D Tech			DLP-Link [Default]	
				Off	
	3D → 2D			3D [Default]	
				L	
	3D Format			R	
				Auto [Default]	
				SBS	
				Top and Bottom	
	3D Sync Invert			Frame Sequential	
				On	
	Reset			Off [Default]	
			Cancel [Default]		
	Aspect Ratio			Yes	
				4:3	
				16:9	
				16:10	
				LBX	
				Native	
			Auto [Default]		

USING THE PROJECTOR

Main Menu	Sub Menu	Sub Menu 2	Sub Menu 3	Sub Menu 4	Values	
Display	Edge Mask				0 ~ 10 [Default: 0]	
	Zoom				-5 ~ 25 [Default: 0]	
	Digital Lens Shift	V			-30 ~ 30 [Default: 0]	
	Image Shift	H			-100 ~ 100 [Default: 0]	
		V			-100 ~ 100 [Default: 0]	
	Geometric Correction	Four Corner Adjustment				
		H Keystone			-40 ~ 40 steps (-10~10 degree) [Default: 0]	
V Keystone				-40 ~ 40 steps (-10~10 degree) [Default: 0]		
Reset						
Audio	Audio Settings				Auto [Default]	
					Internal Speaker	
					Audio Out	
	Mute				Off [Default]	
					On	
	Mic				Off	
					On [Default]	
Volume				0 ~ 10 [Default: 5]		
Mic Volume				0 ~ 10 [Default: 5]		
Setup	Projection				Front  [Default]	
					Rear 	
					Ceiling-top 	
					Rear-top 	
	Screen Type				16:9	
					16:10 [Default]	
	Filter Settings	Filter Usage Hours				(read only)
		Optional Filter Installed				Yes
						No [Default]
		Filter Reminder				Off
						300hr
						500hr [Default]
						800hr
	Filter Reset				1000hr	
					Cancel [Default]	
Power Settings	Direct Power On				Yes	
					Off [Default]	
					On	

USING THE PROJECTOR

Main Menu	Sub Menu	Sub Menu 2	Sub Menu 3	Sub Menu 4	Values
Setup	Power Settings	Signal Power On			Off [Default] On
		Auto Power Off (min.)			0 ~ 180 (1 min increments) [Default: 20]
		Sleep Timer (min.)			0 ~ 990 (30 min increments) [Default: 0]
			Always On		No [Default] Yes
		Power Mode (Standby)			Active Eco
	Security	Security			Off [Default] On
		Security Timer	Month		
			Day		
			Hour		
	HDMI Link Settings	HDMI Link			Off On
		Inclusive of TV			No Yes
		Power On Link			Mutual PJ → Device Device → PJ
	Power Off Link			Off On	
	Test Pattern				Green Grid Magenta Grid White Grid White Off [Default]
	Remote Settings [depends on remote]	IR Function			On [Default] Off
		Remote Code			00~99

USING THE PROJECTOR

Main Menu	Sub Menu	Sub Menu 2	Sub Menu 3	Sub Menu 4	Values		
Setup	Remote Settings [depends on remote]	F1			Test Pattern		
					Brightness		
					Contrast		
					Sleep Timer		
					Color Matching		
					Color Temp		
					Gamma		
					Projection		
					Digital Lens Shift [Default]		
		F2			Test Pattern		
					Brightness [Default]		
					Contrast		
					Sleep Timer		
					Color Matching		
					Color Temp		
					Gamma		
					Projection		
					Digital Lens Shift		
		F3			Test Pattern		
					Brightness		
					Contrast		
					Sleep Timer [Default]		
					Color Matching		
					Color Temp		
					Gamma		
					Projection		
					Digital Lens Shift		
			Projector ID				00 ~ 99

USING THE PROJECTOR

Main Menu	Sub Menu	Sub Menu 2	Sub Menu 3	Sub Menu 4	Values		
Setup	Options	Language			English [Default]		
					Deutsch		
					Français		
					Italiano		
					Español		
					Português		
					Polski		
					Nederlands		
					Svenska		
					Norsk/Dansk		
					Suomi		
					ελληνικά		
					繁體中文		
					簡體中文		
					日本語		
					한국어		
					Русский		
					Magyar		
					Čeština		
					عربي		
				ไทย			
				Türkçe			
				فارسی			
				Tiếng Việt			
				Bahasa Indonesia			
				Română			
				Slovenčina			
			Menu Settings	Menu Location			Top left 
						Top right 	
						Center  [Default]	
						Bottom left 	
						Bottom right 	
			Menu Settings	Menu Timer			Off
		5sec					
		10sec [Default]					
	Auto Source				Off [Default]		
					On		

USING THE PROJECTOR

Main Menu	Sub Menu	Sub Menu 2	Sub Menu 3	Sub Menu 4	Values		
Setup	Options	Input Source			HDMI1		
					HDMI2		
					VGA		
		Input Name	HDMI1			Default [Default]	
						Custom	
			HDMI2			Default [Default]	
						Custom	
			VGA			Default [Default]	
						Custom	
		High Altitude				Off [Default]	
						On	
		Display Mode Lock				Off [Default]	
						On	
		Keypad Lock				Off [Default]	
						On	
		Information Hide				Off [Default]	
						On	
		Logo				Default [Default]	
						Neutral	
						User	
		Background Color				None	
						Blue [Default]	
						Red	
						Green	
						Gray	
						Logo	
		HDMI Settings	EDID Reminder			Off	
						On [Default]	
			HDMI 1 EDID				1.4 [Default]
							2.0
			HDMI 2 EDID				1.4
							2.0 [Default]
		Reset	Reset OSD				Cancel [Default]
							Yes
			Reset to Default				Cancel [Default]
							Yes

USING THE PROJECTOR

Main Menu	Sub Menu	Sub Menu 2	Sub Menu 3	Sub Menu 4	Values
Network	LAN	Network Status			(read only)
		MAC Address			(read only)
		DHCP			Off [Default]
					On
		IP Address			192.168.0.100 [Default]
		Subnet Mask			255.255.255.0 [Default]
		Gateway			192.168.0.254 [Default]
		DNS			192.168.0.51 [Default]
	Reset				
	Control	Crestron			Off
					On [Default] Note: Port 41794
		Extron			Off
					On [Default] Note: Port 2023
		PJ Link			Off
					On [Default] Note: Port 4352
		AMX Device Discovery			Off
				On [Default] Note: Port 9131	
Telnet			Off		
			On [Default] Note: Port 23		
HTTP			Off		
			On [Default] Note: Port 80		

USING THE PROJECTOR

Main Menu	Sub Menu	Sub Menu 2	Sub Menu 3	Sub Menu 4	Values
Info	Regulatory				
	Serial Number				
	Source				
	Resolution				00x00
	Refresh Rate				0.00Hz
	Display Mode				
	Power Mode (Standby)				
	Light Source Hours				
	Remote Code				00~99
	Remote Code(Active)				00~99
	Network Status				
	IP Address				
	Projector ID				00~99
	Filter Usage Hours				
	Brightness Mode				
	FW Version	System			
LAN					
MCU					

USING THE PROJECTOR

Display menu

Display image settings menu

Display Mode

There are many factory presets optimized for various types of images.

- **Presentation:** This mode is suitable for showing in front of public in connection to the PC.
- **Bright:** Maximum brightness from PC input.
- **HDR / HLG:** Decodes High Dynamic Range (HDR) / Hybrid Log Gamma (HLG) content. This mode will be automatically enabled if HDR/HLG is set to Auto (and HDR/HLG Content is sent to projector – 4K UHD Blu-ray, 1080p/4K UHD HDR/HLG Games, 4K UHD Streaming Video). While HDR/HLG mode is active, other display modes (Cinema, Reference, etc.) cannot be selected as HDR/HLG delivers color that is highly accurate, exceeding the color performance of the other display modes.

Note: *When EDID 2.0 is selected, HDMI 1/2 can support HDR / HLG format.*

- **Cinema:** Provides the best colors for watching movies.
- **sRGB:** Standardized accurate color.
- **DICOM SIM.:** This mode can project a monochrome medical image such as an X ray radiography, MRI, etc.
- **Blending:** A video mode which is appropriate for blending application.
- **User:** Memorize user's settings.
- **3D:** To experience the 3D effect, you need to have 3D glasses, make sure your PC/portable device has a 120 Hz signal output quad buffered graphics card and have a 3D Player installed.

Wall Color

Use this function to obtain an optimized screen image according to the wall color. Select between off, blackboard, light yellow, light green, light blue, pink, and gray.

Dynamic Range

Configure the High Dynamic Range (HDR) / Hybrid Log Gamma(HLG) setting and its effect when displaying video from 4K Blu-ray players and streaming devices.

Note: *Only HDMI supports the Dynamic Range function.*

➤ **HDR/HLG**

- **Off:** Turn off HDR/HLG Processing. When set to Off, the projector will NOT decode HDR/HLG content.
- **Auto:** Auto detect HDR/HLG signal.

➤ **HDR Picture Mode / HLG Picture Mode**

- **Bright:** Choose this mode for brighter more saturated colors.
- **Standard:** Choose this mode for natural looking colors with a balance of warm and cool tones.
- **Film:** Choose this mode for improved detail and image sharpness.
- **Details:** The signal comes from OETF conversion to achieve the best color matching.

Note:

- *The **HDR Picture Mode** adjusts the HDR rendering effect when the input signal is HDR. Similarly, the **HLG Picture Mode** adjusts the HLG rendering effect when the input signal is HLG.*
- ***HDR Picture Mode** option is only available when the input signal is HDR, and **HLG Picture Mode** option will be grayed out and vice versa.*

Brightness

Adjust the brightness of the image.

USING THE PROJECTOR

Contrast

The contrast controls the degree of difference between the lightest and darkest parts of the picture.

Sharpness

Adjust the sharpness of the image.

Color

Adjust a video image from black and white to fully saturated color.

Tint

Adjust the color balance of red and green.

Gamma

Set up gamma curve type. After the initial setup and fine tuning is completed, utilize the Gamma Adjustment steps to optimize your image output.

- **Film:** For home theater.
- **Video:** For video or TV source.
- **Graphics:** For PC / Photo source.
- **Standard(2.2):** For standardized setting.
- **1.8 / 2.0 / 2.4 / 2.6:** For specific PC / Photo source.

Note: *These options are only available if:*

- *the 3D mode function is disabled.*
- *the **Wall Color** setting is not set to **Blackboard**.*
- *the **Display Mode** setting is not set to **DICOM SIM.**, **HDR**, or **HLG**.*

Color Settings

Configure the color settings.

- **BrilliantColor™:** This adjustable item utilizes a new color-processing algorithm and enhancements to enable higher brightness while providing true, more vibrant colors in picture.
- **Color Temperature:** Select a color temperature from Warm, Standard, Cool, or Cold.
- **Color Matching:** Select the following options:
 - Color: Adjust the red (R), green (G), black (B), cyan (C), yellow (Y), magenta (M), and white (W) level of the image.
 - Hue: Adjust the color balance of red and green.
 - Saturation: Adjust a video image from black and white to fully saturated color.
 - Gain: Adjust the image brightness.
 - Reset: Return the factory default settings for color matching.
 - Exit: Exit the “Color Matching” menu.
- **RGB Gain/Bias:** This settings allows to configure the brightness (gain) and contrast (bias) of an image.
 - Reset: Return the factory default settings for RGB gain/bias.
 - Exit: Exit the “RGB Gain/Bias” menu.
- **Color Space (non-HDMI input only):** Select an appropriate color matrix type from the following: AUTO, RGB, or YUV.
- **Color Space (HDMI input only):** select an appropriate color matrix type from the following: Auto, RGB(0-255), RGB(16-235), and YUV.

USING THE PROJECTOR

Signal

Adjust the signal options.

- **Automatic:** Configure automatically the signal (the frequency and phase items are grayed out). If automatic is disabled, the frequency and phase items will appear for tuning and saving the settings.
- **Frequency:** Change the display data frequency to match the frequency of your computer's graphic card. Use this function only if the image appears to flicker vertically.
- **Phase:** Synchronize the signal timing of the display with the graphic card. If the image appears to be unstable or flickers, use this function to correct it.
- **H. Position:** Adjust the horizontal positioning of the image.
- **V. Position:** Adjust the vertical positioning of the image.

Note: *This menu is only available if the input source is RGB/Component.*

Brightness Mode

Adjust the brightness mode settings.

- **DynamicBlack:** Use to automatically adjust the picture brightness in order to give optimum contrast performance.
- **Eco.:** Choose "Eco." to dim the projector light source which will lower power consumption and extend the light source life.
- **Constant Power:** Choose the power percentage for brightness mode.
- **Constant Luminance:** Constant Luminance varies the strength of LD luminance such that the brightness maintains consistent with time.

Reset

Return the factory default settings for color settings.

Display enhanced gaming menu

Enhanced Gaming

Use this function to enable/disable the system to reduce response times (input latency) during gaming.

- **On:** Reduce the latency of image that can display image simultaneously.
- **Off:** Without reduce the latency.

Note: *When the Enhanced Gaming function is turned on, the Keystone, 4-corner, Aspect Ratio, Zoom, 3D, and Screen Type will be unavailable.*

USING THE PROJECTOR

Display 3D menu

Note:

- *This projector is a 3D ready projector with DLP-Link 3D solution.*
- *Please make sure your 3D glasses are use for DLP-Link 3D before enjoy your video.*
- *This projector supports frame sequential (page-flip) 3D via HDMI1/HDMI2/VGA ports.*
- *To enable 3D mode, the input frame rate should be set to 60Hz only, lower or higher frame rate is not supported.*
- *To reach the best performance, resolution 1920x1080 is recommended, please be noted that 4K (3840x2160) resolution is not supported in 3D mode.*

3D Mode

Use this option to disable or enable the 3D function.

- **Off:** Select “Off” to turn off 3D mode.
- **On:** Select “On” to turn on 3D mode.

3D Tech

Use this option to select 3D technology.

- **DLP-Link:** Select to use optimized settings for DLP 3D Glasses.
- **Off:** Turn off the DLP-Link function.

3D → 2D

Use this option to specify how the 3D content should appear on the screen.

- **3D:** Display 3D signal.
- **L (Left):** Display the left frame of 3D content.
- **R (Right):** Display the right frame of 3D content.

3D Format

Use this option to select the appropriate 3D format content.

- **Auto:** When a 3D identification signal is detected, the 3D format is selected automatically.
- **SBS:** Display 3D signal in “Side-by-Side” format.
- **Top and Bottom:** Display 3D signal in “Top and Bottom” format.
- **Frame Sequential:** Display 3D signal in “Frame Sequential” format.

3D Sync Invert

Use this option to enable/disable the 3D sync invert function.

Reset

Return the factory default setting for 3D settings.

- **Cancel:** Select to cancel Reset.
- **Yes:** Select to return the factory default settings for 3D.

USING THE PROJECTOR

Display aspect ratio menu

Aspect Ratio

Select the aspect ratio of the displayed image between the following options:

- **4:3**: This format is for 4:3 input sources.
- **16:9**: This format is for 16:9 input sources, like HDTV and DVD enhanced for Wide screen TV.
- **16:10** (for WUXGA model only): This format is for 16:10 input sources, like widescreen laptops.
- **LBX**: This format is for non-16x9, letterbox source and if you use external 16x9 lens to display 2.35:1 aspect ratio in full resolution.
- **Native**: This format displays the original image without any scaling.
- **Auto**: Automatically selects the appropriate display format.

Note:

- Detailed informations about LBX mode:
 - Some Letter-Box Format DVDs are not enhanced for 16x9 TVs. In this situation, the image will not look right when displaying image in 16:9 mode. In this situation, please try to use the 4:3 mode to view the DVD. If the content is not 4:3, there will be black bars around the image in 16:9 display. For this type of content, you can use LBX mode to fill the image on the 16:9 display.
 - If you use an external anamorphic lens, this LBX mode also allows you to watch a 2.35:1 content (include Anamorphic DVD and HDTV film source) that supports anamorphic wide is enhanced for 16x9 Display in a wide 2.35:1 image. In this case, there are no black bars. Light source power and vertical resolution are fully utilized.

WUXGA scaling table for 1920 x 1200 DMD (screen type 16:10):

Note:

- Supported screen type 16:10 (1920 x 1200), 16:9 (1920x1080).
- When screen type is 16:9, the 16x10 format becomes unavailable.
- When screen type is 16:10, the 16x9 format becomes unavailable.
- If you select auto option then the display mode will be also automatically changed.

16 : 10 screen	480i/p	576i/p	1080i/p	720p	PC
4x3	Scale to 1600x1200.				
16x9	Scale to 1920x1080.				
16x10	Scale to 1920x1200.				
LBX	Scale to 1920x1440, then get the central 1920x1200 image to display.				
Native mode	- 1:1 mapping centered. - No scaling will be made; the image is displayed with the resolution based on input source.				
Auto	- If this format is selected, the screen type will automatically become 16:10 (1920x1200). - If source is 4:3, the screen type will be scaled to 1600x1200. - If source is 16:9, the screen type will be scaled to 1920x1080. - If source is 16:10, the screen type will be scaled to 1920x1200.				

USING THE PROJECTOR

WUXGA auto mapping rule (screen type 16:10):

Auto	Input resolution		Auto/Scale	
	H-resolution	V-resolution	1920	1200
4:3	640	480	1600	1200
	800	600	1600	1200
	1024	768	1600	1200
	1280	1024	1600	1200
	1400	1050	1600	1200
	1600	1200	1600	1200
Wide Laptop	1280	720	1920	1080
	1280	768	1920	1152
	1280	800	1920	1200
SDTV	720	576	1350	1080
	720	480	1620	1080
HDTV	1280	720	1920	1080
	1920	1080	1920	1080

WUXGA scaling table (screen type 16:9):

16 : 10 screen	480i/p	576i/p	1080i/p	720p	PC
4x3	Scale to 1440x1080.				
16x9	Scale to 1920x1080.				
LBX	Scale to 1920x1440, then get the central 1920x1080 image to display.				
Native mode	<ul style="list-style-type: none"> - 1:1 mapping centered. - No scaling will be made; the image is displayed with the resolution based on input source. 				
Auto	<ul style="list-style-type: none"> - If this format is selected, the screen type will automatically become 16:9 (1920x1080). - If source is 4:3, the screen type will be scaled to 1440x1080. - If source is 16:9, the screen type will be scaled to 1920x1080. - If source is 16:10, the screen type will be scaled to 1920x1200 and cut 1920x1080 area to display. 				

WUXGA auto mapping rule (screen type 16:9):

Auto	Input resolution		Auto/Scale	
	H-resolution	V-resolution	1920	1080
4:3	640	480	1440	1080
	800	600	1440	1080
	1024	768	1440	1080
	1280	1024	1440	1080
	1400	1050	1440	1080
	1600	1200	1440	1080
Wide Laptop	1280	720	1920	1080
	1280	768	1800	1080
	1280	800	1728	1080
SDTV	720	576	1350	1080
	720	480	1620	1080

USING THE PROJECTOR

HDTV	1280	720	1920	1080
	1920	1080	1920	1080

Display edge mask menu

Edge Mask

Use this function to remove the video encoding noise on the edge of video source.

Display zoom menu

Zoom

Use to reduce or magnify an image on the projection screen.

Display digital lens shift menu

Digital Lens Shift

Digital lens shift is only available under screen type 16:9. Display area moves forward between the upper and lower limits of the adjustable region in vertical position similar with real lens shift.

Display image shift menu

Image Shift

Adjust the zoom to make the projected image smaller until you can see all four corners, and then adjust the projected image position horizontally (H) or vertically (V). Image shift is only available under screen type 16:9 and zoom > 0.

Display geometric correction menu

Four Corner Adjustment

Allow the image to be squeezed to fit an area defined by moving each of the four corners' x and y position.

H Keystone

Adjust image distortion horizontally and make a squarer image. Horizontal keystone is used to correct a keystone image shape in which the left and right borders of the image are unequal in length. This is intended for use with horizontally on-axis applications.

V Keystone

Adjust image distortion vertically and make a squarer image. Vertical keystone is used to correct a keystone image shape in which the top and bottom are slanted to one of the sides. This is intended when for use with vertically on-axis applications.

Display reset menu

Reset

Return the factory default settings for the Display settings.

USING THE PROJECTOR

Audio menu

Audio audio settings menu

Audio Settings

Select the audio output device.

- **Auto:** When the external speaker is properly connected, the sound will come out from the speaker. Otherwise, the sound will come out from the internal speaker.
- **Internal Speaker:** Always from internal speaker.
- **Audio Out:** Always from the external speaker.

Audio mute menu

Mute

Use this option to temporarily turn off the sound.

- **On:** Choose “On” to turn mute on.
- **Off:** Choose “Off” to turn mute off.

Note: *“Mute” function affects both internal and external speaker volume.*

Audio mic menu

Mic

Turn on/off the microphone.

- **On:** Choose “On” to turn on the microphone.
- **Off:** Choose “Off” to turn off the microphone.

Audio volume menu

Volume

Adjust the volume level.

Audio mic volume menu

Mic Volume

Adjust the microphone volume level.

USING THE PROJECTOR

Setup menu

Setup projection menu

Projection

Select the preferred projection between front, rear, ceiling-top, and rear-top.

Setup screen type menu

Screen Type

Choose the screen type from 16:9 and 16:10.

Setup filter settings menu

Filter Usage Hours

Display the filter time.

Optional Filter Installed

Set the warning message setting.

- **Yes:** Display warning message after 500 hours of use.

Note: *"Filter Usage Hours / Filter Reminder / Filter Reset" will only appear when "Optional Filter Installed" is "Yes".*

- **No:** Turn off warning message.

Filter Reminder

Choose this function to show or hide the warning message when the changing filter message is displayed. The available options include Off, 300hr, 500hr, 800hr, and 1000hr.

Filter Reset

Reset the dust filter counter after replacing or cleaning the dust filter.

USING THE PROJECTOR

Setup power settings menu

Direct Power On

Choose “On” to activate Direct Power mode. The projector will automatically power on when AC power is supplied, without pressing the “Power” key on the projector keypad or on the remote control.

Signal Power On

Choose “On” to activate Signal Power mode. The projector will automatically power on when a signal is detected, without pressing the “Power” key on the projector Keypad or on the remote control.

Note: *If the “Signal Power On” option is turned “On”, the power consumption of the projector in standby mode will be over 3W.*

Auto Power Off (min.)

Sets the countdown timer interval. The countdown timer will start, when there is no signal being sent to the projector. The projector will automatically power off when the countdown has finished (in minutes).

Sleep Timer (min.)

Configure the sleep timer.

- **Sleep Timer (min.):** Sets the countdown timer interval. The countdown timer will start, with or without a signal being sent to the projector. The projector will automatically power off when the countdown has finished (in minutes).
Note: *The Sleep Timer is reset every time when the projector is powered off.*
- **Always On:** Check to set the sleep timer always on.

Power Mode (Standby)

Set the power mode setting.

- **Active:** Choose “Active” to return to normal standby.
- **Eco:** Choose “Eco.” to save power dissipation further < 0.5W.

Note: *LAN control is workable when the **Power Mode (Standby)** setting is set to Active.*

Setup security menu

Security

Enable this function to prompt for a password before using the projector.

- **On:** Choose “On” to use security verification when the turning on the projector.
- **Off:** Choose “Off” to be able to switch on the projector without password verification.

Security Timer

Can be select the time (Month/Day/Hour) function to set the number of hours the projector can be used. Once this time has elapsed you will be requested to enter your password again.

Change Password

Use to set or modify the password that is prompted when turning the projector on.

USING THE PROJECTOR

Setup HDMI link settings menu

Note:

- When you connect HDMI CEC-compatible devices to the projector with HDMI cables, you can control them on the same power on or power off status using the HDMI Link control feature in the projector's OSD. This lets one device or multiple devices in a group power on or power off via HDMI Link Feature in a typical configuration, your DVD player may be connected to the projector through an amplifier or home theater system.

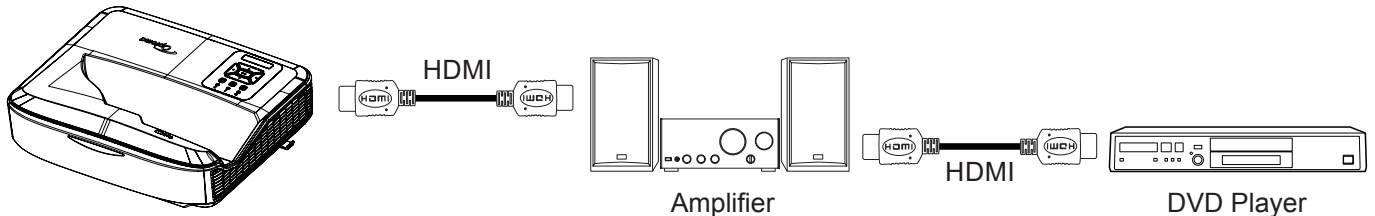

HDMI Link

Enable/disable the HDMI Link function. The inclusive TV, power on link, and power off link options will only be available if the setting is set to "On".

Inclusive of TV

Set to "Yes" if you prefer both TV and projector to be automatically turned off at the same time. To prevent both devices to be turned off at the same time, set the setting to "No".

Power On Link

CEC power on command.

- **Mutual:** Both projector and CEC device will be turned on simultaneously.
- **PJ → Device:** The CEC device will be turned on only after the projector is switched on.
- **Device → PJ:** The projector will be switched on only after the CEC device is turned on.

Power Off Link

Enable this function to let both HDMI Link and projector to be automatically turned off at the same time.

Setup test pattern menu

Test Pattern

Select the test pattern from green grid, magenta grid, white grid, white, or disable this function (off).

Setup remote settings menu

IR Function

Set the IR function setting.

- **On:** Choose "On", the projector can be operated by the remote control from the top and front IR receivers.
- **Off:** Choose "Off", the projector can't be operated by the remote control. By selecting "Off", you will be able to use the Keypad keys.

Remote Code

Set the remote custom code by pressing the remote ID button for 3 seconds and you will notice the remote indicator (above the Off button) starts blinking. Then, input a number between 00-99 using the keyboard numbered keys. After inserting the number, the remote indicator blinks twice quickly indicating that the remote code has changed.

USING THE PROJECTOR

F1/F2/F3

Assign the default function for F1, F2, or F3 between Test Pattern, Brightness, Contrast, Sleep Timer, Color Matching, Color Temp, Gamma, Projection, or Digital Lens Shift.

Setup projector ID menu

Projector ID

ID definition can be set up by menu (range 0-99), and allow user control an individual projector by using RS232 command.

Setup options menu

Language

Select the multilingual OSD menu between English, German, French, Italian, Spanish, Portuguese, Polish, Dutch, Swedish, Norwegian/Danish, Finnish, Greek, traditional Chinese, simplified Chinese, Japanese, Korean, Russian, Hungarian, Czechoslovak, Arabic, Thai, Turkish, Farsi, Vietnamese, Indonesian, Romanian, and Slovakian.

Menu Settings

Set the menu location on the screen and configure menu timer settings.

- **Menu Location:** Select the menu location on the display screen.
- **Menu Timer:** Set the duration where the OSD menu stays visible on the screen.

Auto Source

Choose this option to let the projector automatically find an available input source.

Input Source

Select the input source between HDMI1, HDMI2, and VGA.

Input Name

Use to rename the input function for easier identification. The available options include HDMI1, HDMI2, and VGA.

High Altitude

When "On" is selected, the fans will spin faster. This feature is useful in high altitude areas where the air is thin.

Display Mode Lock

Choose "On" or "Off" to lock or unlock adjusting display mode settings.

Keypad Lock

When the keypad lock function is "On", the Keypad will be locked. However, the projector can be operated by the remote control. By selecting "Off", you will be able to reuse the Keypad.

Information Hide

Enable this function to hide the information message.

- **Off:** Choose "Off" to show the "searching" message.
- **On:** Choose "On" to hide the info message.

Logo

Use this function to set the desired startup screen. If changes are made, they will take effect the next time the projector is powered on.

- **Default:** The default startup screen.
- **Neutral:** Logo is not displayed on startup screen.
- **User:** Logo capture tool required.

USING THE PROJECTOR

Note:

1. Please set the “Logo” item to “User” in projector setup menu.
2. Perform following steps to enter download mode.
 - A: Press the “Enter” and “Power” buttons on the control panel and hold them down.
 - B: Plug-in the power cord to the projector.
 - C: Release both “Enter” and “Power” buttons after all LEDs are both lighted up.
3. Connect the **USB (Type A to B) cable** form projector (Type B port) to the computer (Type A port).
4. Double-click the **Splash Downloader.exe** (only support Window OS).
5. While the Splash Downloader is executing please check USB status before upgrade firmware. It should show (Projector found).

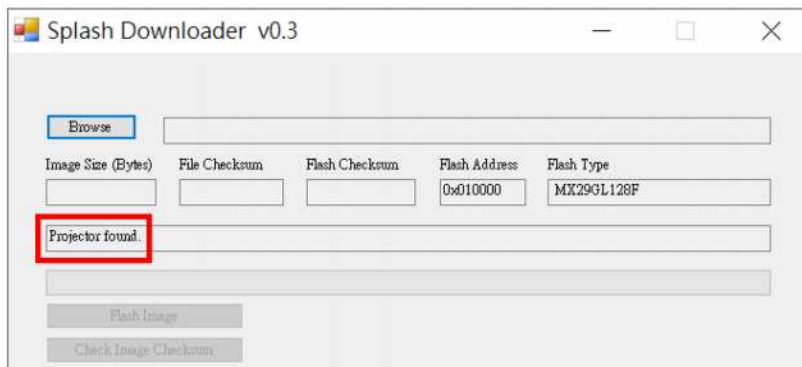

6. Click the “**Browse**” button and select logo file (**only support “PNG” file format**). The recommended resolution of logo should not exceed the default logo resolution (For example ZU500USTe, maximum resolution is 1920x1200). The purpose is that keeping the quality of the image. If not, the logo may be blurred.
7. Click the “**Flash Image**” button. If the file was written to projector successfully, the message “**Download Complete**” will be displayed on the screen.
8. Plug-out the power core of projector and plug-in it. Please ensure that the logo has been upgraded correctly.

Background Color

Use this function to display a blue, red, green, gray color, none, or logo screen when no signal is available.

Note: *If the background color is set to “None”, then the background color is black.*

HDMI Settings

Configure the HDMI settings.

- **EDID Reminder:** Enable to display a reminder message when the input source is changed to the HDMI source.
- **HDMI 1 EDID (default is EDID 1.4):** Select this option when using 1080p sources (Xbox 360, Cable Box, Satellite Box, etc.).
- **HDMI 2 EDID (default is EDID 2.0):** Select this option when using 1080p HDR sources (such as Xbox One S or PS4) and 4K HDR sources (4K HDR Blu-ray Player, Roku Ultra 4K, SHIELD TV, Xbox One X and PS4 Pro, etc.).

Note: *When the HDMI 2 source is abnormal in color and or color banding, change the EDID to 1.4.*

USING THE PROJECTOR

Setup reset OSD menu

Reset OSD

Return the factory default settings for OSD menu settings.

Reset to Default

Return the factory default settings for all settings.

Network menu

Network LAN menu

Network Status

Display the network connection status (read-only).

MAC Address

Display the MAC address (read-only).

DHCP

Use this option to enable or disable the DHCP function.

- **Off:** To assign IP, subnet mask, gateway, and DNS configuration manually.
- **On:** Projector will obtain an IP address automatically from your network.

Note: *Exiting OSD will automatically apply the entered values.*

IP Address

Display the IP address.

Subnet Mask

Display subnet mask number.

Gateway

Display the default gateway of the network connected to the projector.

DNS

Display the DNS number.

How to use web browser to control your projector

1. Turn "On" the DHCP option on projector to allow a DHCP server to automatically assign an IP address.
2. Open the web browser in your computer and type in the projector's IP address ("Network > LAN > IP Address").
3. Enter the user name and password, and click "Login".
The projector's configuration web interface opens.

Note:

- *It is needed to change the username and password once you have logged in. It is also advised to use a strong password.*
- *The steps in this section is based on Windows 7 operating system.*

USING THE PROJECTOR

Making a direct connection from your computer to the projector*

1. Turn “Off” the DHCP option on the projector.
2. Configure the IP address, Subnet Mask, Gateway, and DNS on projector (“Network > LAN”).
3. Open **Network and Sharing Center** page on your computer, and assign the identical network parameters to your computer as set on projector. Click “OK” to save the parameters.

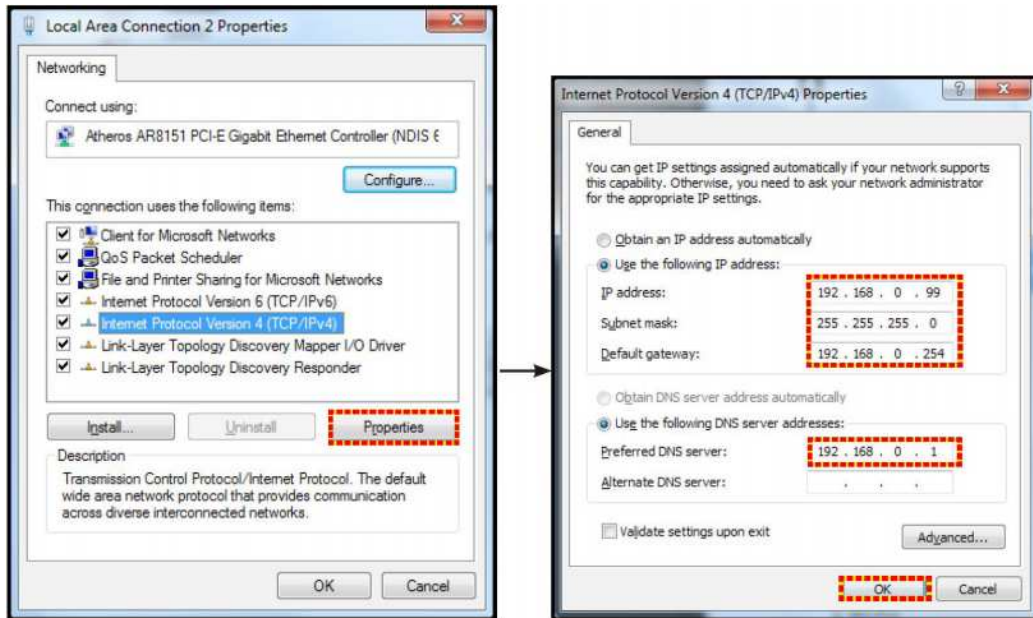

4. Open the web browser on your computer and type in to the URL field the IP address, assigned in step 3. Then press “Enter” key.

Reset

Reset all values for LAN parameters.

Network control menu

Crestron

Use this function to select the network function (port: 41794).

For more information, please visit <http://www.crestron.com> and www.crestron.com/getroomview.

Extron

Use this function to select the network function (port: 2023).

PJ Link

Use this function to select the network function (port: 4352).

AMX Device Discovery

Use this function to select the network function (port: 9131).

Telnet

Use this function to select the network function (port: 23).

HTTP

Use this function to select the network function (port: 80).

USING THE PROJECTOR

Setup network control settings menu

LAN RJ45 function

For simplicity and ease of operation, the projector provides diverse networking and remote management features. The LAN / RJ45 function of the projector through a network, such as remotely manage: Power On / Off, brightness, and contrast settings. Also, you can view the projector status information, such as: Video- Source, Sound-Mute, etc.

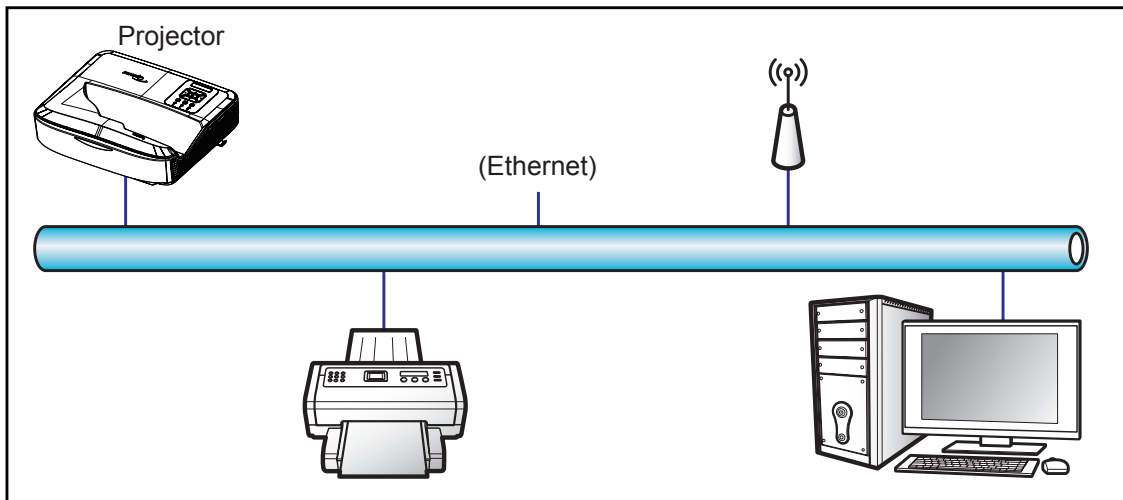

Wired LAN terminal functionalities

This projector can be controlled by using a computer or other external device via LAN / RJ45 port and compatible with Crestron / Extron / AMX (Device -Discovery) / PJLink.

- Crestron is a registered trademark of Crestron Electronics, Inc. of the United States.
- Extron is a registered trademark of Extron Electronics, Inc. of the United States.
- AMX is a registered trademark of AMX LLC of the United States.
- PJLink applied for trademark and logo registration in Japan, the United States of America, and other countries by JBMIA.

The projector is supported by the specified commands of the Crestron Electronics controller and related software, for example RoomView®.

<http://www.crestron.com/>

This projector is compliant to support Extron device(s) for reference.

<http://www.extron.com/>

This projector is supported by AMX (Device Discovery).

<http://www.amx.com/>

This projector supports all commands of PJLink Class1 (Version 1.00).

<http://pjlink.jbmia.or.jp/english/>

For more detailed information about the various types of external devices which can be connected to the LAN / RJ45 port and remote control the projector, as well as the supported commands for these external devices, please contact the Support-Service directly.

USING THE PROJECTOR

LAN RJ45

1. Connect an RJ45 cable to RJ45 ports on the projector and the computer.

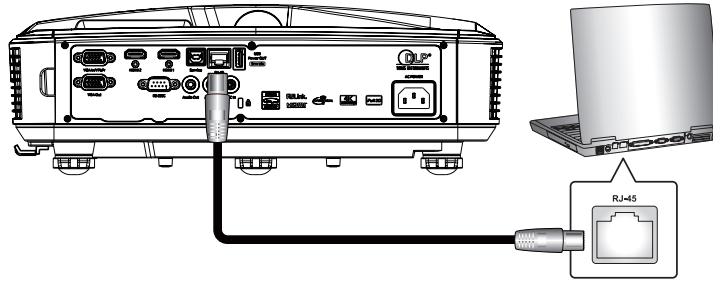

2. On the computer, select **Start > Settings > Network & Internet**.

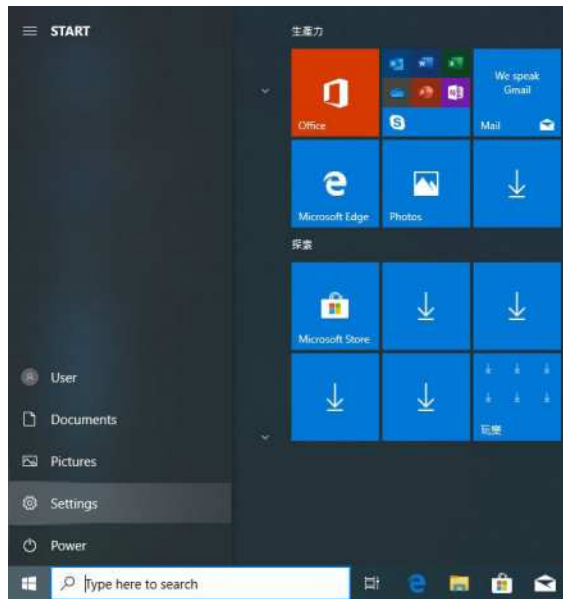

3. Right-click on the **Local Area Connection**, and select **Property**.

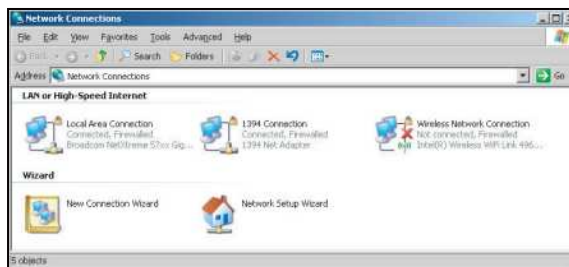

4. In the **Properties** window, select the **General** tab, and select **Internet Protocol (TCP / IP)**.

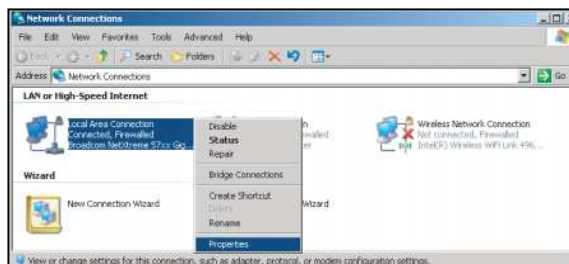

USING THE PROJECTOR

5. Click “Properties”.

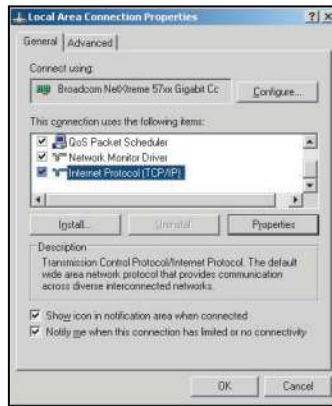

6. Type in the IP address and Subnet mask, then press “OK”.



7. Press the “Menu” button on the projector.

8. Open on projector Network > LAN.

9. Enter the following connection parameters:

- DHCP: Off
- IP Address: 192.168.0.100
- Subnet Mask: 255.255.255.0
- Gateway: 192.168.0.254
- DNS: 192.168.0.51

10. Press “Enter” to confirm settings.

11. Open a web browser, for example Microsoft Internet Explorer with Adobe Flash Player 9.0 or higher installed.

12. In the Address bar, input the projector’s IP address: 192.168.0.100.



13. Press “Enter”.

USING THE PROJECTOR

The projector is setup for remote management. The LAN / RJ45 function displays as follows:

Because “Browsers” no longer support Adobe Flash player, please download and install the “Download the Flash Player projector” application from Adobe link: https://www.adobe.com/support/flashplayer/debug_downloads.html.

Information page



Main page



Tool page

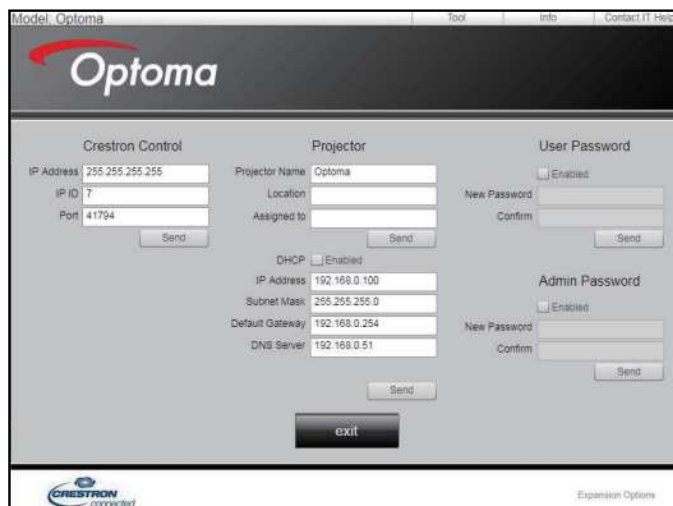

USING THE PROJECTOR

Contact IT helpdesk



RS232 by Telnet Function

There is alternative RS232 command control way, in projector so called “RS232 by TELNET” for LAN / RJ45 interface.

Quick Start-Guide for “RS232 by Telnet”

- Check and get the IP address on OSD of the projector.
- Make sure that the computer can access the web-page of the projector.
- Make sure that “Windows Firewall” setting is set disabled in case of “TELNET” function filtering out by PC / laptop.



1. Select **Start > All Programs.> Accessories > Command Prompt.**

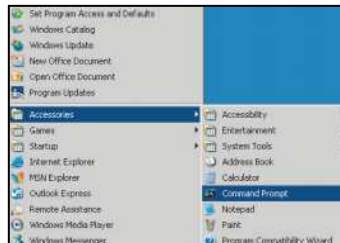

2. Input the command format as follows:
 - telnet ttt.xxx.yyy.zzz 23 (“Enter” key pressed)
 - (ttt.xxx.yyy.zzz: IP-Address of the projector)
3. If Telnet-Connection ready, and user can have RS232 command input, then “Enter” key pressed, the RS232 command will be workable.

Specification for “RS232 by TELNET”:

1. Telnet: TCP.
2. Telnet port: 23 (for more detail, kindly please get contact with the service agent or team).
3. Telnet utility: Windows “TELNET.exe” (console mode).
4. Disconnection for RS232-by-Telnet control normally: Close
5. Windows Telnet utility directly after TELNET connection ready.
 - Limitation 1 for Telnet-Control: there is less than 50 bytes for successive network payload for Telnet-Control application.

USING THE PROJECTOR

- Limitation 2 for Telnet-Control: there is less than 26 bytes for one complete RS232 command for Telnet-Control.
- Limitation 3 for Telnet-Control: Minimum delay for next RS232 command must be more than 200 (ms).

Note: *Please refer to RS232 command protocol list on page 70.*

Info menu

Info menu

View the projector information as listed below:

- Regulatory
- Serial Number
- Source
- Resolution
- Refresh Rate
- Display Mode
- Power Mode (Standby)
- Light Source Hours
- Remote Code
- Remote Code(Active)
- Network Status
- IP Address
- Projector ID
- Filter Usage Hours
- Brightness Mode
- FW Version

ADDITIONAL INFORMATION

Compatible resolutions

Digital

Digital (HDMI 1_2.0)				
B0 / Established Timing	B0 / Standard Timing	B0 / Detail Timing	B1 / Video Mode	B1 / Detail Timing
640 x 480 @ 60Hz	640 x 480 @ 120Hz	WUXGA: 1920x1200 @60Hz	640 x 480p @ 60Hz 4:3	3840 x 2160 @ 60Hz 1920 x 1080 @ 60Hz
640 x 480 @ 67Hz	800 x 600 @ 120Hz		720(1440) x 480i @ 60Hz 4:3	
640 x 480 @ 72Hz	1024 x 768 @ 120Hz		720(1440) x 480i @ 60Hz 16:9	
640 x 480 @ 75Hz	4:3		720(1440) x 576i @ 50Hz 4:3	
800 x 600 @ 56Hz	1280 x 720 @ 60Hz		720(1440) x 576i @ 50Hz 16:9	
800 x 600 @ 60Hz	16:9		720 x 480p @ 60Hz 4:3	
800 x 600 @ 72Hz	1280 x 720 @ 120Hz		720 x 480p @ 60Hz 16:9	
800 x 600 @ 75Hz	16:9		720 x 576p @ 50Hz 4:3	
1024 x 768 @ 60Hz	1280 x 800 @ 60Hz		720 x 576p @ 50Hz 16:9	
1024 x 768 @ 70Hz	16:10		1280 x 720p @ 50Hz 16:9	
1024 x 768 @ 75Hz	1440 x 900 @ 60Hz		1280 x 720p @ 60Hz 16:9	
1152 x 870 @ 75Hz	16:10		1440 x 480p @ 60Hz 16:9	
1280 x 1024 @ 75Hz	1600 x 1200 @ 60Hz		1440 x 576p @ 50Hz 16:9	
	4:3		1920 x 1080i @ 60Hz 16:9	
			1920 x 1080i @ 50Hz 16:9	
			1920 x 1080p @ 60Hz 16:9	
			1920 x 1080p @ 50Hz 16:9	
		1920 x 1080p @ 24Hz 16:9		
		1920 x 1080p @ 30Hz 16:9		
		3840 x 2160p @ 24Hz 16:9		
		3840 x 2160p @ 25Hz 16:9		
		3840 x 2160p @ 30Hz 16:9		
		3840 x 2160p @ 50Hz 16:9		
		3840 x 2160p @ 60Hz 16:9		
		4096 x 2160p @ 24Hz 256:135		
		4096 x 2160p @ 25Hz 256:135		
		4096 x 2160p @ 30Hz 256:135		
		4096 x 2160p @ 50Hz 256:135		
		4096 x 2160p @ 60Hz 256:135		

ADDITIONAL INFORMATION

Digital (HDMI 2_2.0)				
B0 / Established Timing	B0 / Standard Timing	B0 / Detail Timing	B1 / Video Mode	B1 / Detail Timing
640 x 480 @ 60Hz 640 x 480 @ 67Hz 640 x 480 @ 72Hz 640 x 480 @ 75Hz 800 x 600 @ 56Hz 800 x 600 @ 60Hz 800 x 600 @ 72Hz 800 x 600 @ 75Hz 1024 x 768 @ 60Hz 1024 x 768 @ 70Hz 1024 x 768 @ 75Hz 1152 x 870 @ 75Hz 1280 x 1024 @ 75Hz	640 x 480 @ 120Hz 800 x 600 @ 120Hz 1024 x 768 @ 120Hz 4:3 1280 x 720 @ 60Hz 16:9 1280 x 720 @ 120Hz 16:9 1280 x 800 @ 60Hz 16:10 1440 x 900 @ 60Hz 16:10 1600 x 1200 @ 60Hz 4:3	1080p: 1920x1080 @60Hz	640 x 480p @ 60Hz 4:3 720(1440) x 480i @ 60Hz 4:3 720(1440) x 480i @ 60Hz 16:9 720(1440) x 576i @ 50Hz 4:3 720(1440) x 576i @ 50Hz 16:9 720 x 480p @ 60Hz 4:3 720 x 480p @ 60Hz 16:9 720 x 576p @ 50Hz 4:3 720 x 576p @ 50Hz 16:9 1280 x 720p @ 50Hz 16:9 1280 x 720p @ 60Hz 16:9 1440 x 480p @ 60Hz 16:9 1440 x 576p @ 50Hz 16:9 1920 x 1080i @ 60Hz 16:9 1920 x 1080i @ 50Hz 16:9 1920 x 1080p @ 60Hz 16:9 1920 x 1080p @ 50Hz 16:9 1920 x 1080p @ 24Hz 16:9 1920 x 1080p @ 30Hz 16:9 3840 x 2160p @ 24Hz 16:9 3840 x 2160p @ 25Hz 16:9 3840 x 2160p @ 30Hz 16:9 3840 x 2160p @ 50Hz 16:9 3840 x 2160p @ 60Hz 16:9 4096 x 2160p @ 24Hz 256:135 4096 x 2160p @ 25Hz 256:135 4096 x 2160p @ 30Hz 256:135 4096 x 2160p @ 50Hz 256:135 4096 x 2160p @ 60Hz 256:135	3840 x 2160 @ 60Hz 1920 x 1200 @ 60Hz

ADDITIONAL INFORMATION

Digital (HDMI 1_1.4)				
B0 / Established Timing	B0 / Standard Timing	B0 / Detail Timing	B1 / Video Mode	B1 / Detail Timing
640 x 480 @ 60Hz 640 x 480 @ 67Hz 640 x 480 @ 72Hz 640 x 480 @ 75Hz 800 x 600 @ 56Hz 800 x 600 @ 60Hz 800 x 600 @ 72Hz 800 x 600 @ 75Hz 1024 x 768 @ 60Hz 1024 x 768 @ 70Hz 1024 x 768 @ 75Hz 1152 x 870 @ 75Hz 1280 x 1024 @ 75Hz	640 x 480 @ 120Hz 800 x 600 @ 120Hz 1024 x 768 @ 120Hz 4:3 1280 x 720 @ 60Hz 16:9 1280 x 720 @ 120Hz 16:9 1280 x 800 @ 60Hz 16:10 1440 x 900 @ 60Hz 16:10 1600 x 1200 @ 60Hz 4:3	WUXGA: 1920x1200@60Hz	640 x 480p @ 60Hz 4:3 720 x 480p @ 60Hz 4:3 720 x 480p @ 60Hz 16:9 720(1440) x 480i @ 60Hz 4:3 720(1440) x 480i @ 60Hz 16:9 720(1440) x 576i @ 50Hz 4:3 720(1440) x 576i @ 50Hz 16:9 720 x 576p @ 50Hz 4:3 720 x 576p @ 50Hz 16:9 1280 x 720p @ 50Hz 16:9 1280 x 720p @ 60Hz 16:9 1440 x 480p @ 60Hz 16:9 1440 x 576p @ 50Hz 16:9 1920 x 1080i @ 60Hz 16:9 1920 x 1080i @ 50Hz 16:9 1920 x 1080p @ 24Hz 16:9 1920 x 1080p @ 25Hz 16:9 1920 x 1080p @ 30Hz 16:9 1920 x 1080p @ 60Hz 16:9 1920 x 1080p @ 50Hz 16:9	1280 x 720 @ 60Hz 1366 x 768 @ 60Hz 1920 x 720 @ 60Hz 1920 x 1080 @ 60Hz

ADDITIONAL INFORMATION

Digital (HDMI 2_1.4)				
B0 / Established Timing	B0 / Standard Timing	B0 / Detail Timing	B1 / Video Mode	B1 / Detail Timing
640 x 480 @ 60Hz 640 x 480 @ 67Hz 640 x 480 @ 72Hz 640 x 480 @ 75Hz 800 x 600 @ 56Hz 800 x 600 @ 60Hz 800 x 600 @ 72Hz 800 x 600 @ 75Hz 1024 x 768 @ 60Hz 1024 x 768 @ 70Hz 1024 x 768 @ 75Hz 1152 x 870 @ 75Hz 1280 x 1024 @ 75Hz	640 x 480 @ 120Hz 800 x 600 @ 120Hz 1024 x 768 @ 120Hz 4:3 1280 x 720 @ 60Hz 16:9 1280 x 720 @ 120Hz 16:9 1280 x 800 @ 60Hz 16:10 1440 x 900 @ 60Hz 16:10 1600 x 1200 @ 60Hz 4:3	1080p: 1920x1080 @60Hz	640 x 480p @ 60Hz 4:3 720 x 480p @ 60Hz 4:3 720 x 480p @ 60Hz 16:9 720(1440) x 480i @ 60Hz 4:3 720(1440) x 480i @ 60Hz 16:9 720(1440) x 576i @ 50Hz 4:3 720(1440) x 576i @ 50Hz 16:9 720 x 576p @ 50Hz 4:3 720 x 576p @ 50Hz 16:9 1280 x 720p @ 50Hz 16:9 1280 x 720p @ 60Hz 16:9 1440 x 480p @ 60Hz 16:9 1440 x 576p @ 50Hz 16:9 1920 x 1080i @ 60Hz 16:9 1920 x 1080i @ 50Hz 16:9 1920 x 1080p @ 24Hz 16:9 1920 x 1080p @ 25Hz 16:9 1920 x 1080p @ 30Hz 16:9 1920 x 1080p @ 60Hz 16:9 1920 x 1080p @ 50Hz 16:9	1280 x 720 @ 60Hz 1366 x 768 @ 60Hz 1920 x 720 @ 60Hz 1920 x 1080 @ 60Hz

Analog

Analog				
B0 / Established Timing	B0 / Standard Timing	B0 / Detail Timing	B1 / Video Mode	B1 / Detail Timing
640 x 480 @ 60Hz 640 x 480 @ 67Hz 640 x 480 @ 72Hz 640 x 480 @ 75Hz 800 x 600 @ 56Hz 800 x 600 @ 60Hz 800 x 600 @ 72Hz 800 x 600 @ 75Hz 1024 x 768 @ 60Hz 1024 x 768 @ 70Hz 1024 x 768 @ 75Hz 1152 x 870 @ 75Hz 1280 x 1024 @ 75Hz	640 x 480 @ 120Hz 800 x 600 @ 120Hz 1024 x 768 @ 120Hz 4:3 1280 x 720 @ 60Hz 16:9 1280 x 720 @ 120Hz 16:9 1280 x 800 @ 60Hz 16:10 1440 x 900 @ 60Hz 16:10 1600 x 1200 @ 60Hz 4:3	WUXGA: 1920x1200@60Hz	1920 x 1080 @ 60Hz 16:9 1366 x 768 @ 60Hz 16:9 1920 x 720 @ 60Hz 16:6	N/A

ADDITIONAL INFORMATION

True 3D video compatibility

Input resolutions	HDMI 1.4a 3D Input	Input timing	
		1280 x 720P @ 50Hz	Top-and-Bottom
		1280 x 720P @ 60Hz	Top-and-Bottom
		1280 x 720P @ 50Hz	Frame packing
		1280 x 720P @ 60Hz	Frame packing
		1920 x 1080i @ 50Hz	Side-by-Side(Half)
		1920 x 1080i @ 60Hz	Side-by-Side(Half)
		1920 x 1080P @ 24Hz	Top-and-Bottom
		1920 x 1080P @ 24Hz	Frame packing
		640 x 480 @ 120Hz	Frame sequential
		800 x 600 @ 120Hz	Frame sequential
		1024 x 768 @ 120Hz	Frame sequential
		1280 x 720 @ 120Hz	Frame sequential

Note:

- If 3D input is 1080p@24Hz, the DMD should replay with integral multiple with 3D mode.
- Support NVIDIA 3DTV Play if there is no patent fee from Optoma.
- 1080i@25Hz and 720p@50Hz will run in 100Hz; 1080p@24Hz will run in 144Hz; other 3D timing will run in 120Hz.
- HDMI input lag: 49.7 ms

ADDITIONAL INFORMATION

RS232 Port Setting and Signals Connection

RS232 Port Setting

Items	Method
Communication Method	Asynchronous Communication
Bits Per Seconds	9600
Data Bits	8 bits
Parity	None
Stop Bits	1
Flow Control	None

RS232 Signals Connection

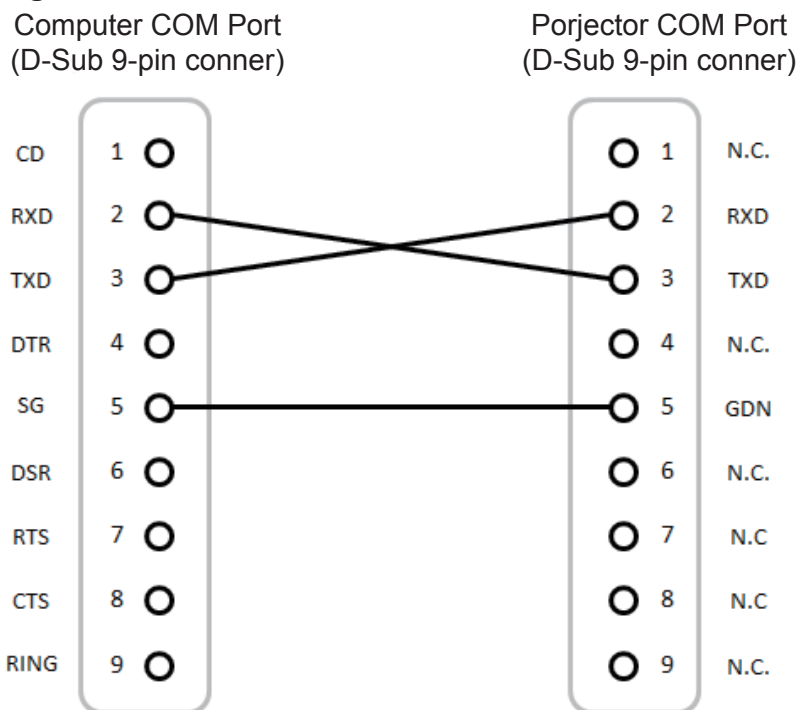

Note: RS232 shell is grounded.

ADDITIONAL INFORMATION

Adjusting Projection Image Size (Diagonal)

- Projection Image Size from 132" to 155" (3.353 to 3.937 meters)

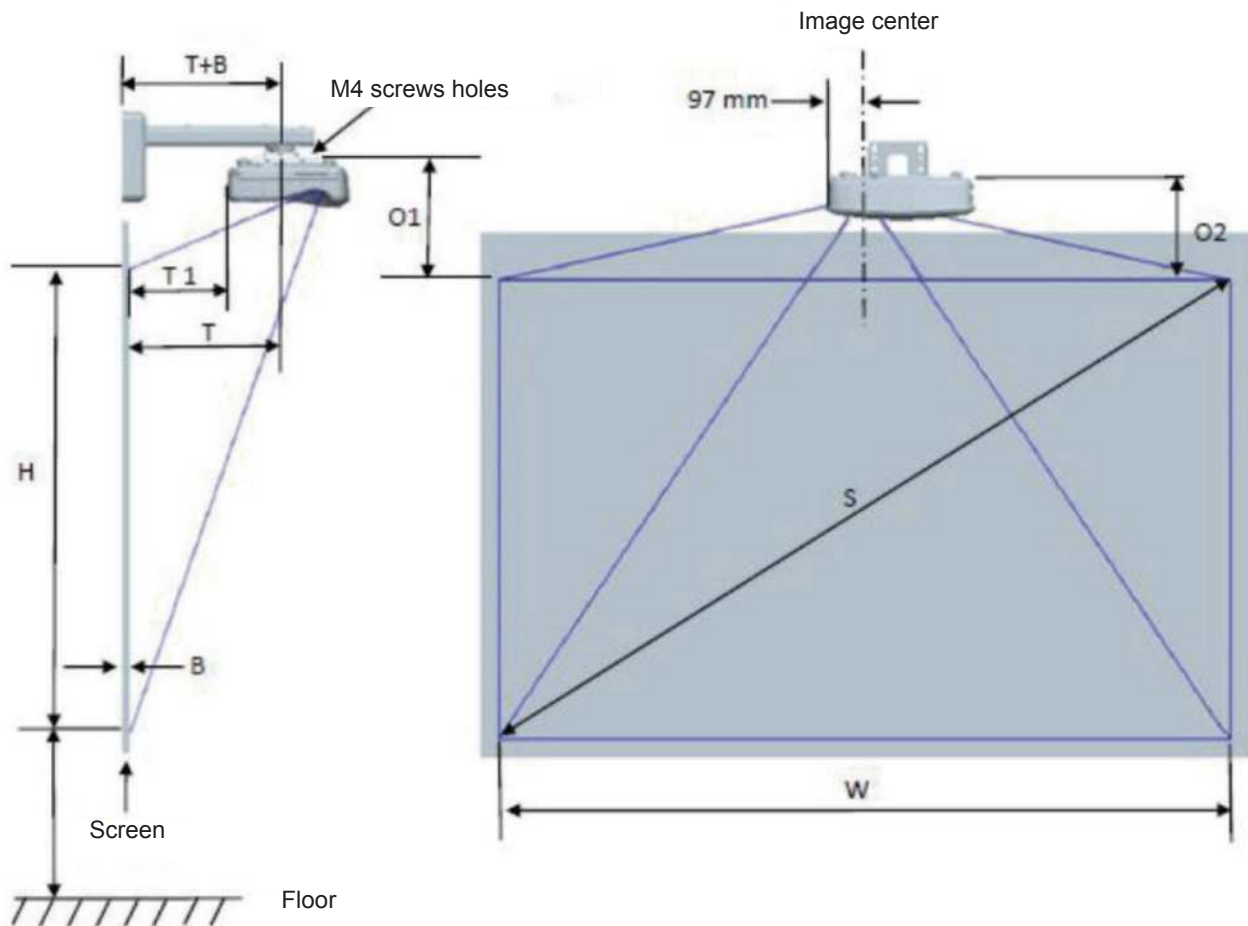

WUXGA (16:10) Wall mount installation measurement chart

Diagonal image size (S) in inch	Diagonal image size (S) in mm	Image Width (W) in mm	Image height (H) in mm	Throw distance	Offset	Offset tolerance (+/-)	Distance from surface of whiteboard to center of projector mount (T) in mm	Distance from surface of whiteboard to back of projector (T1) in mm	Distance from top of image to top of interface boss (O1) in mm	Distance from top of image to top of projector (O2) in mm
132	3353	2843	1777	719	298	36	594	457	361	341
135	3429	2908	1817	736	304	36	611	474	367	347
140	3556	3015	1885	763	316	38	638	501	379	359
145	3683	3123	1952	790	327	39	665	528	390	370
150	3810	3231	2019	817	338	40	692	555	401	381
155	3937	3339	2087	845	349	42	720	583	412	392

Note: This table is for user's reference only.

ADDITIONAL INFORMATION

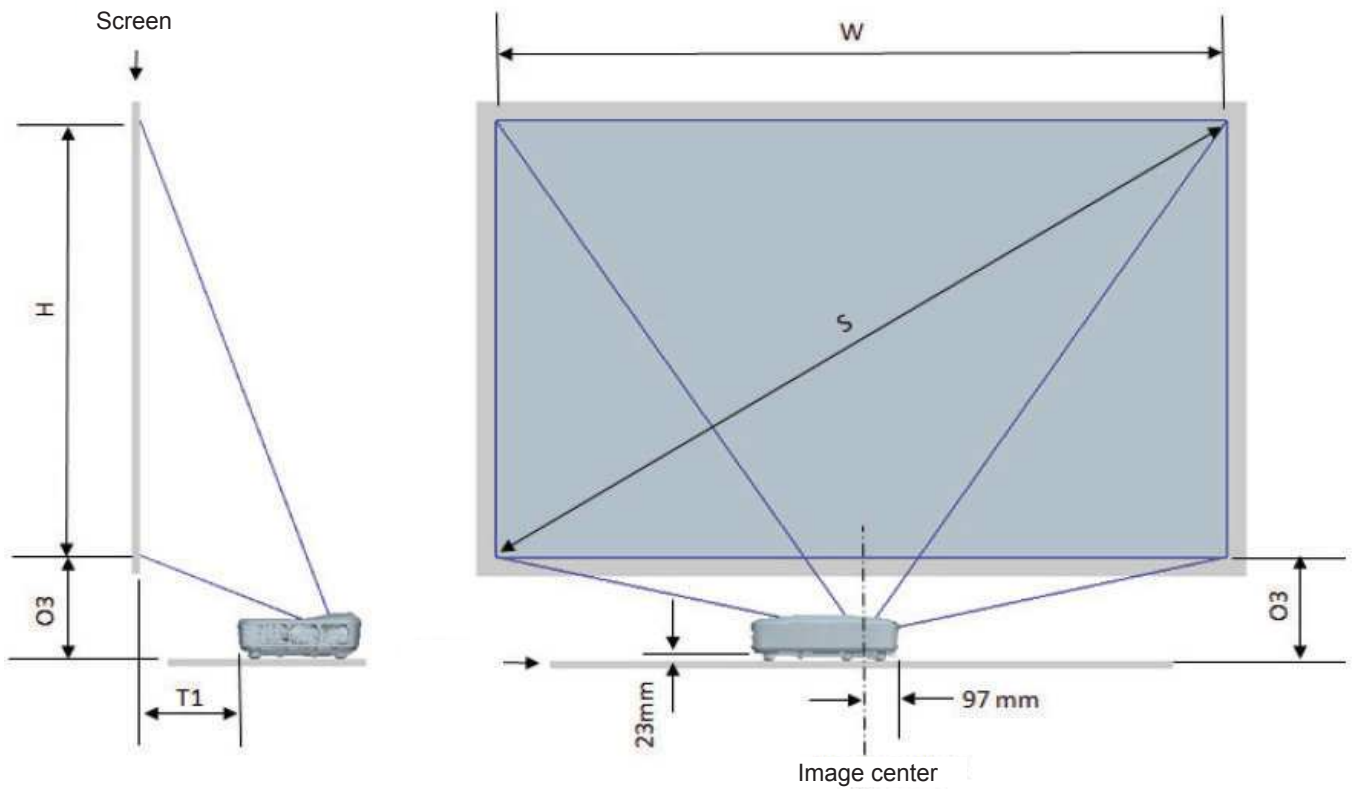

WUXGA (16:10) Table mount installation measurement chart

diagonal image size(S) in inch	diagonal image size(S) in mm	Image width (W) in mm	Image height (H) in mm	Trow distance in mm	Distance from surface of whiteboard to back of projector (T1) in mm	Distance from bottom of image to top of table (O3) in mm
132	3353	2843	1777	719	457	364
135	3429	2908	1817	736	474	370
140	3556	3015	1885	763	501	382
145	3683	3123	1952	790	528	393
150	3810	3231	2019	817	555	404
155	3937	3339	2087	845	583	415

ADDITIONAL INFORMATION

Projector dimensions and ceiling mount installation

1. To prevent damage to your projector, please use the Optoma ceiling mount.
2. If you wish to use a third party ceiling mount kit, please ensure the screws used to attach a mount to the projector meet the following specifications:
 - Screw type: M4*10
 - Minimum screw length: 10mm

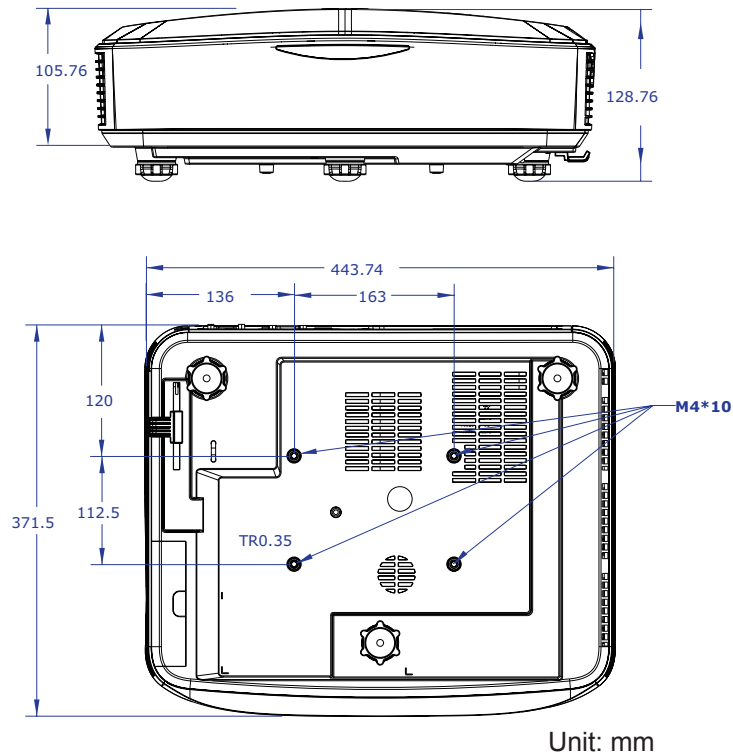

Note: Please note that damage resulting from incorrect installation will void the warranty.



Warning:

- If you buy a ceiling mount from another company, please be sure to use the correct screw size. Screw size will vary depending on the thickness of the mounting plate.
- Be sure to keep at least 10 cm gap between the ceiling and the bottom of the projector.
- Avoid installing the projector near a heat source.

ADDITIONAL INFORMATION

IR remote codes

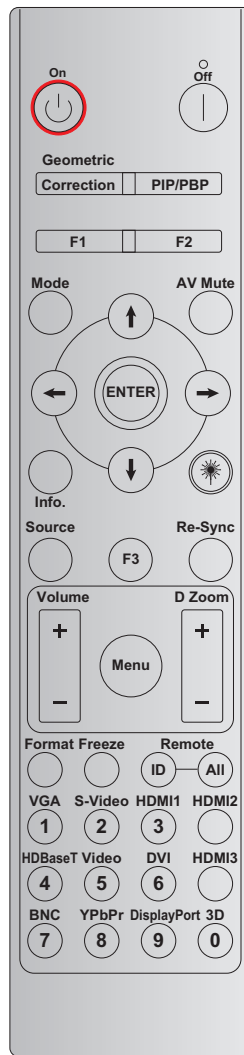

Key	Printing-key definition	Key code				Repeat
		BYTE1	BYTE2	BYTE3	BYTE4	
		customer 0	customer 1	data 0	data 1	
Power On	On	32	CD	02	#BYTE3	F2
Power Off	Off	32	CD	2E	#BYTE3	F2
Geometric Correction	Geometric Correction	32	CD	96	#BYTE3	F2
PIP/PBP	PIP/PBP	32	CD	78	#BYTE3	F2
F1	F1	32	CD	26	#BYTE3	F2
F2	F2	32	CD	27	#BYTE3	F2
Mode	Mode	32	CD	95	#BYTE3	F2
Four directional select keys (↑/↓/←/→)	Up arrow	32	CD	C6	#BYTE3	F2
	Down arrow	32	CD	C7	#BYTE3	F2
	Left arrow	32	CD	C8	#BYTE3	F2
	Right arrow	32	CD	C9	#BYTE3	F2
Enter	Enter	32	CD	C5	#BYTE3	F2
AV Mute	AV Mute	32	CD	03	#BYTE3	F2
Information	Info.	32	CD	25	#BYTE3	F2

ADDITIONAL INFORMATION

Key	Printing-key definition	Key code				Repeat
		BYTE1	BYTE2	BYTE3	BYTE4	
		customer 0	customer 1	data 0	data 1	
Laser ✱	Laser	N/A	N/A	N/A	N/A	N/A
Source	Source	32	CD	18	#BYTE3	F2
F3	F3	32	CD	66	#BYTE3	F2
Re-Sync	Re-Sync	32	CD	04	#BYTE3	F2
Volume	Volume +	32	CD	09	#BYTE3	F2
	Volume -	32	CD	0C	#BYTE3	F2
D Zoom	D Zoom +	32	CD	08	#BYTE3	F2
	D Zoom -	32	CD	0B	#BYTE3	F2
Menu	Menu	32	CD	88	#BYTE3	F2
Format	Format	32	CD	15	#BYTE3	F2
Freeze	Freeze	32	CD	06	#BYTE3	F2
Remote	Remote ID	3201~ 3299		N/A		
	Remote All	32CD		N/A		
VGA / 1	1/VGA	32	CD	8E	#BYTE3	F2
S-Video / 2	2/S-Video	32	CD	1D	#BYTE3	F2
HDMI1 / 3	3/HDMI1	32	CD	16	#BYTE3	F2
HDMI2	HDMI2	32	CD	9B	#BYTE3	F2
HDBaseT / 4	4/HDBaseT	32	CD	70	#BYTE3	F2
Video / 5	5/Video	32	CD	1C	#BYTE3	F2
DVI / 6	6/DVI	32	CD	19	#BYTE3	F2
HDMI3	HDMI3	32	CD	98	#BYTE3	F2
BNC / 7	7/BNC	32	CD	1A	#BYTE3	F2
YPbPr / 8	8/YPbPr	32	CD	17	#BYTE3	F2
Display Port / 9	9/DisplayPort	32	CD	9F	#BYTE3	F2
3D / 0	0/3D	32	CD	89	#BYTE3	F2

Note:

- The remote control will enter sleep mode if no any key press, or more than two keys are pressed at the same time, or one key is pressed for more than 60 seconds.
- When pressing and holding the "All" key for more than 3 seconds, and the red LED will flash quickly, this indicates the customer code is reset to its default code (32 CD).
- To switch the customer code, press and hold the "ID" key for more than 3 seconds, and the red LED will flash slowly. Then press 2 number keys within 10 seconds.
For example, to switch the customer code to 3201, do the following:
Press and hold the "ID" key for more than 3 seconds, then release the "ID" key, then press key "0", and then press key "1".
But if you press 2 number keys for more than 10 seconds, the customer code won't change.
You can set the customer code from 32 01 to 32 99.
- The LED indicator will light 10 seconds when any key is pressed, then it will flash slowly within 5 seconds if no keys are pressed. But if press any key is pressed, the time will restart calibration.
- The remote control will remember the customer code until the batteries run out.

ADDITIONAL INFORMATION

Troubleshooting

If you experience a problem with your projector, please refer to the following information. If a problem persists, please contact your local reseller or service center.

Image problems

No image appears on-screen

- Ensure all the cables and power connections are correctly and securely connected as described in the “Installation” section.
- Ensure the pins of connectors are not crooked or broken.
- Ensure that the “Mute” feature is not turned on.

Image is out of focus

- Make sure the projection screen is between the required distance from the projector. (Please refer to pages 28).

The image is stretched when displaying 16:9 DVD title

- When you play anamorphic DVD or 16:9 DVD, the projector will show the best image in 16: 9 format on projector side.
- If you play the LBX format DVD title, please change the format as LBX in projector OSD.
- If you play 4:3 format DVD title, please change the format as 4:3 in projector OSD.
- Please setup the display format as 16:9 (wide) aspect ratio type on your DVD player.

Image is too small or too large

- Move the projector closer to or further from the screen.
- Press “Menu” on the projector panel, go to “Display → Aspect Ratio”. Try the different settings.

Image has slanted sides:

- If possible, reposition the projector so that it is centered on the screen and below the bottom of the screen.

Image is reversed

- Select “Setup → Projection” from the OSD and adjust the projection direction.

ADDITIONAL INFORMATION

Other problems

 *The projector stops responding to all controls*

- If possible, turn off the projector, then unplug the power cord and wait at least 20 seconds before reconnecting power.

Remote control problems

 *If the remote control does not work*

- Check the operating angle of the remote control is pointed within $\pm 30^\circ$ to the IR receiver on the projector.
- Make sure there are not any obstructions between the remote control and the projector. Move to within 12 m (39.4 ft) of the projector.
- Make sure batteries are inserted correctly.
- Replace batteries if they are exhausted.

ADDITIONAL INFORMATION

Warning indicators

When the warning indicators (see below) light up or flash, the projector will automatically shutdown:

- “Lamp” LED indicator is lit red and if “Power” indicator flashes red.
- “Temp” LED indicator is lit red and if “Power” indicator flashes red. This indicates the projector has overheated. Under normal conditions, the project can be switched back on.
- “Temp” LED indicator flashes red and if “Power” indicator flashes red.

Unplug the power cord from the projector, wait for 30 seconds and try again. If the warning indicator light up or flash, please contact your nearest service center for assistance.

LED lightning messages

Message	Power LED		Temp LED	Lamp LED
	(Red)	(Blue)	(Red)	(Red)
Standby state (Input power cord)	Steady light			
Power on (Warming)	Flashing (1 sec off / 1 sec on)			
Power on and Lamp lighting		Steady light		
Power off (Cooling)	Flashing (0.5 sec off / 0.5 sec on) Back to red steady light when cooling fan turns off.			
Error (LD over temp.)			Steady light	
Error (LD failure)				Steady light
Error (Fan failure)			Flashing	
Error (Over temp.)			Steady light	

- Power off:

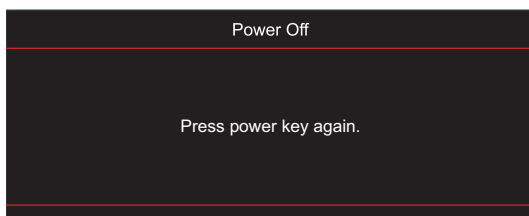

- Temperature warning:

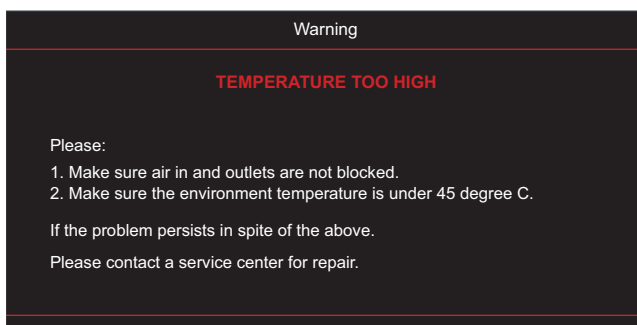

ADDITIONAL INFORMATION

Specifications

Optical	Description
Maximum resolution	WUXGA
Throw ratio	0.253
Zoom / focus adjustment	Fixed zoom and manual focus
Image size (diagonal)	133.5" ~ 154.1"
Projection distance	457mm ~ 583mm

Electrical	Description
Inputs	<ul style="list-style-type: none">• HDMI 2.0 (x2)• VGA In• Audio In 3.5mm• Microphone• USB Type-A for power USB 5V/1.5A
Outputs	<ul style="list-style-type: none">• VGA Out• Audio Out 3.5mm
Control	<ul style="list-style-type: none">• USB Type-B• RS232C• RJ-45 (support web control)
Color reproduction	1073.4 Million color
Scan rate	<ul style="list-style-type: none">• Horizontal scan rate: 15.375~91.146 KHz• Vertical scan rate: 24~85 Hz (120Hz for 3D feature projector)
Built-in speaker	Yes, 10W
Power requirement	100 - 240V ±10%, AC 50/60Hz
Input current	3.7A

Mechanical	Description
Installation orientation	Front, Rear, Ceiling, Rear-top
Dimensions	<ul style="list-style-type: none">• 382(W) x 318(D) x 88(H) mm (without feet)• 382(W) x 318(D) x 115(H) mm (with feet)
Weight	5.8 ±0.5kg
Environmental conditions	Operating in 5~40°C , 10% to 85% humidity (non-condensing)

Note: All specifications are subject to change without notice.