

The BenQ logo is presented in a white, rounded, speech-bubble-like shape. The text "BenQ" is written in a bold, dark blue, sans-serif font, with the "Q" having a distinctive white dot.

Digital Projector

User Manual

Warranty and Copyright information

Limited warranty

BenQ warrants this product against any defects in material and workmanship, under normal usage and storage.

Proof of purchase date will be required with any warranty claim. In the event this product is found to be defective within the warranty period, BenQ's only obligation and your exclusive remedy shall be replacement of any defective parts (labor included). To obtain warranty service, immediately notify the dealer from which you purchased the product of any defects.

Important: The above warranty shall be void if the customer fails to operate the product in accordance with BenQ's written instructions, especially the ambient humidity must be in-between 10% and 90%, temperature in-between 0°C and 35°C, altitude lower than 4920 feet, and avoiding to operate the projector in a dusty environment. This warranty gives you specific legal rights, and you may have other rights which vary from country to country.

For other information, please visit www.BenQ.com.

Copyright

Copyright © 2022 by BenQ Corporation. All rights reserved. No part of this publication may be reproduced, transmitted, transcribed, stored in a retrieval system or translated into any language or computer language, in any form or by any means, electronic, mechanical, magnetic, optical, chemical, manual or otherwise, without the prior written permission of BenQ Corporation.

Disclaimer

BenQ Corporation makes no representations or warranties, either expressed or implied, with respect to the contents hereof and specifically disclaims any warranties, merchantability or fitness for any particular purpose. Further, BenQ Corporation reserves the right to revise this publication and to make changes from time to time in the contents hereof without obligation to notify any person of such revision or changes.

*DLP, Digital Micromirror Device and DMD are trademarks of Texas Instruments. Others are copyrights of their respective companies or organizations.

Patents

Please go to <http://patmarking.benq.com/> for the details on BenQ projector patent coverage.



Table of Contents

Warranty and Copyright information	2
Important safety instructions	4
Introduction	7
Shipping contents	7
Projector exterior view	9
Controls and functions.....	10
Positioning your projector	13
Choosing a location	13
Obtaining a preferred projected image size.....	14
Mounting the projector.....	16
Adjusting the projected image.....	17
Connection	18
Starting up the projector	19
Operation (under Launcher source)	24
BenQ Launcher	24
Navigating the Settings	36
Operation (under non-Launcher source)	40
Using the projector menus under non-Launcher source	40
Securing the projector	41
Menu operation	43
Controlling the projector via LAN	53
Shutting down the projector	54
Direct power off	54
Maintenance	55
Care of the projector	55
Lamp information	55
Troubleshooting	62
Specifications	63
Projector specifications	63
Dimensions	64
Timing chart.....	65

Important safety instructions

Your projector is designed and tested to meet the latest standards for safety of information technology equipment. However, to ensure safe use of this product, it is important that you follow the instructions mentioned in this manual and marked on the product.

1. **Please read this manual before you operate your projector.** Save it for future reference.

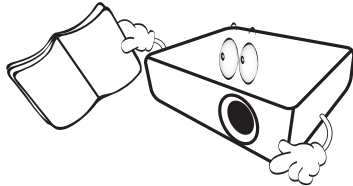

2. **Do not look straight at the projector lens during operation.** The intense light beam may damage your eyes.

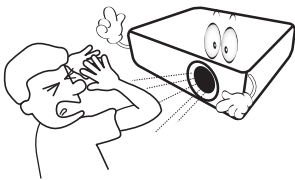

3. **Refer servicing to qualified service personnel.**

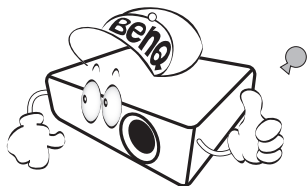

4. **Always open the lens shutter (if any) or remove the lens cap (if any) when the projector lamp is on.**

5. The lamp becomes extremely hot during operation. Allow the projector to cool for approximately 45 minutes prior to removing the lamp assembly for replacement.

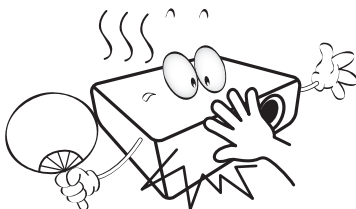

6. In some countries, the line voltage is NOT stable. This projector is designed to operate safely within a mains voltage between 100 to 240 volts AC, but could fail if power cuts or surges of ± 10 volts occur. **In areas where the mains voltage may fluctuate or cut out, it is recommended that you connect your projector through a power stabilizer, surge protector or uninterruptible power supply (UPS).**

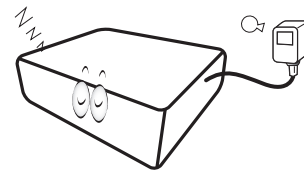

7. Do not block the projection lens with any objects when the projector is under operation as this could cause the objects to become heated and deformed or even cause a fire. To temporarily turn off the lamp, use the blank function.

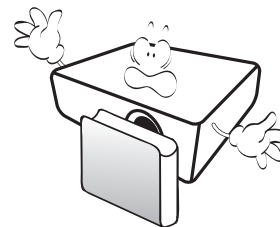

8. Do not operate lamps beyond the rated lamp life. Excessive operation of lamps beyond the rated life could cause them to break on rare occasions.

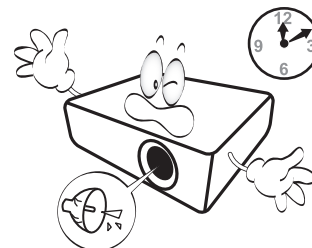

9. Never replace the lamp assembly or any electronic components unless the projector is unplugged.

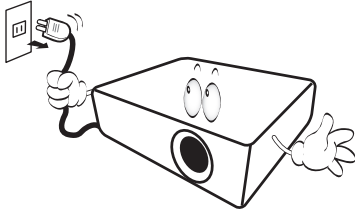

10. Do not place this product on an unstable cart, stand, or table. The product may fall, sustaining serious damage.

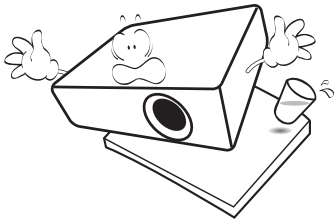

11. Do not attempt to disassemble this projector. There are dangerous high voltages inside which may cause death if you should come into contact with live parts. The only user serviceable part is the lamp which has its own removable cover.

Under no circumstances should you ever undo or remove any other covers. Refer servicing only to suitably qualified professional service personnel.

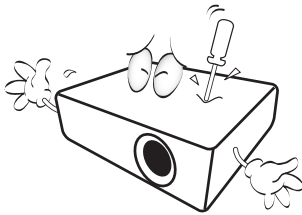

12. Do not block the ventilation holes.

- Do not place this projector on a blanket, bedding or any other soft surface.
- Do not cover this projector with a cloth or any other item.
- Do not place inflammables near the projector.

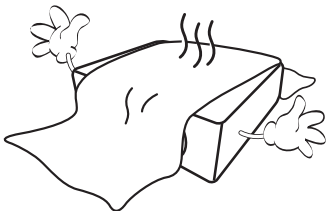

If the ventilation holes are seriously obstructed, overheating inside the projector may result in a fire.

13. Always place the projector on a level, horizontal surface during operation.

- Do not use if tilted at an angle of more than 10 degrees left to right, nor at angle of more than 15 degrees front to back. Using the projector when it is not fully horizontal may cause a malfunction of, or damage to, the lamp.

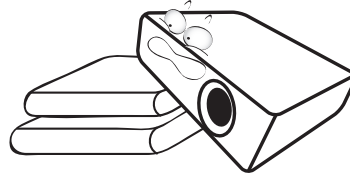

14. Do not stand the projector on end vertically. Doing so may cause the projector to fall over, causing injury or resulting in damage to the projector.

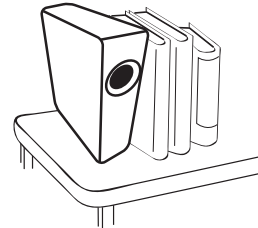

15. Do not step on the projector or place any objects upon it. Besides probable physical damage to the projector, doing so may result in accidents and possible injury.

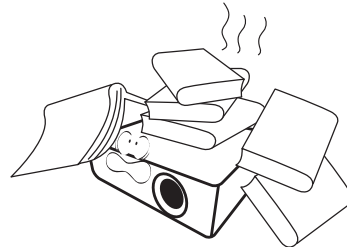

16. When the projector is under operation, you may sense some heated air and odor from its ventilation grill. It is a normal phenomenon and not a product defect.

17. Do not place liquids near or on the projector. Liquids spilled into the projector may cause it to fail. If the projector does become wet, disconnect it from the power supply's power outlet and call BenQ to have the projector serviced.

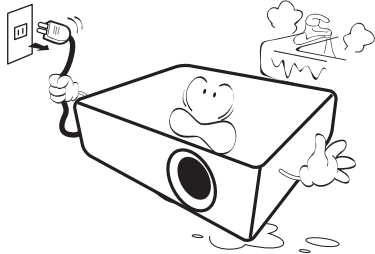

18. This product is capable of displaying inverted images for ceiling/wall mount installation.

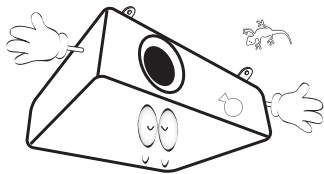

19. This apparatus must be earthed.



- Hg - Lamp contains mercury. Manage in accordance with local disposal laws. See www.lamprecycle.org.
- To avoid damaging the DLP chips, never aim a high-power laser beam into the projection lens.

20. Do not place this projector in any of the following environments.

- Space that is poorly ventilated or confined. Allow at least 50 cm clearance from walls and free flow of air around the projector.
- Locations where temperatures may become excessively high, such as the inside of a car with all windows rolled up.
- Locations where excessive humidity, dust, or cigarette smoke may contaminate optical components, shorten the projector's life span and darken the image.

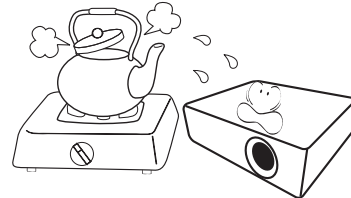

- Locations near fire alarms
- Locations with an ambient temperature above 40°C / 104°F
- Locations where the altitudes are higher than 3000 m (10000 feet).

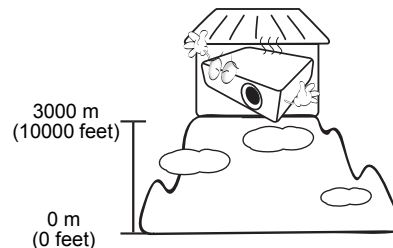

Introduction

Shipping contents

Carefully unpack and verify that you have all of the items shown below. If any of these items are missing, please contact your place of purchase.

Standard accessories

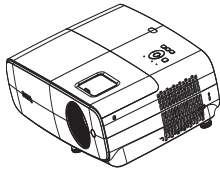

Projector

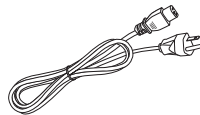

Power cord

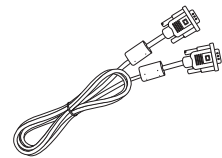

VGA cable

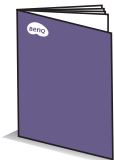

Quick start guide



USB Wi-Fi dongle



Remote control with batteries



Warranty card*



- The supplied accessories will be suitable for your region, and may differ from those illustrated.
- *The warranty card is only supplied in some specific regions. Please consult your dealer for detailed information.

Optional accessories

1. Spare lamp kit
2. 3D glasses

Replacing the remote control batteries

1. Press and open the battery cover, as illustrated.
2. Remove the old batteries (if applicable) and install two AAA batteries. Make sure that the positive and negative ends are positioned correctly, as illustrated.
3. Replace the battery cover until it clicks into place.

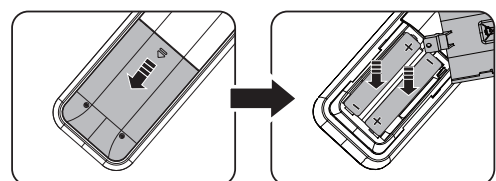

Installing the USB Wi-Fi dongle

Follow the illustrations below to install the USB Wi-Fi dongle. Make sure that the lamp cover is installed back after the USB Wi-Fi dongle is plugged. Do not turn the power on with the lamp cover open.

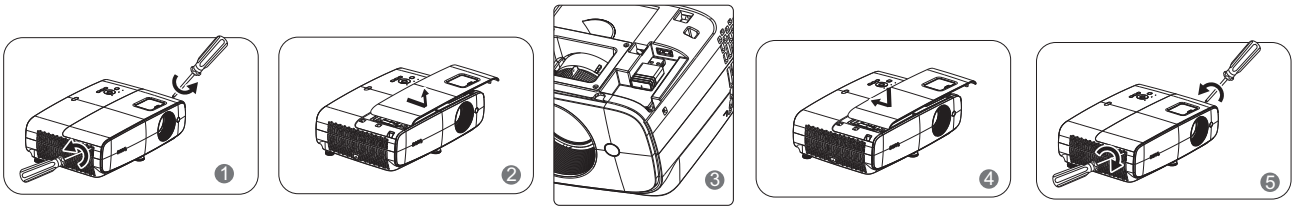

- Avoid leaving the remote control and batteries in an excessive heat or humid environment like the kitchen, bathroom, sauna, sunroom or in a closed car.
- Replace only with the same or equivalent type recommended by the battery manufacturer.
- Dispose of the used batteries according to the manufacturer's instructions and local environment regulations for your region.
- Never throw the batteries into a fire. There may be danger of an explosion.
- If the batteries are dead or if you will not be using the remote control for an extended period of time, remove the batteries to avoid damage to the remote control from possible battery leakage.

Projector exterior view

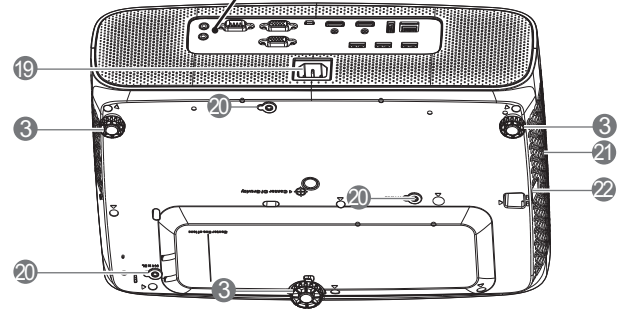
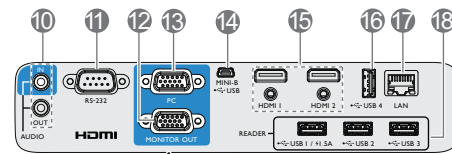
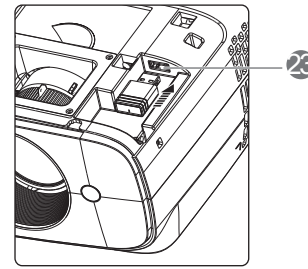
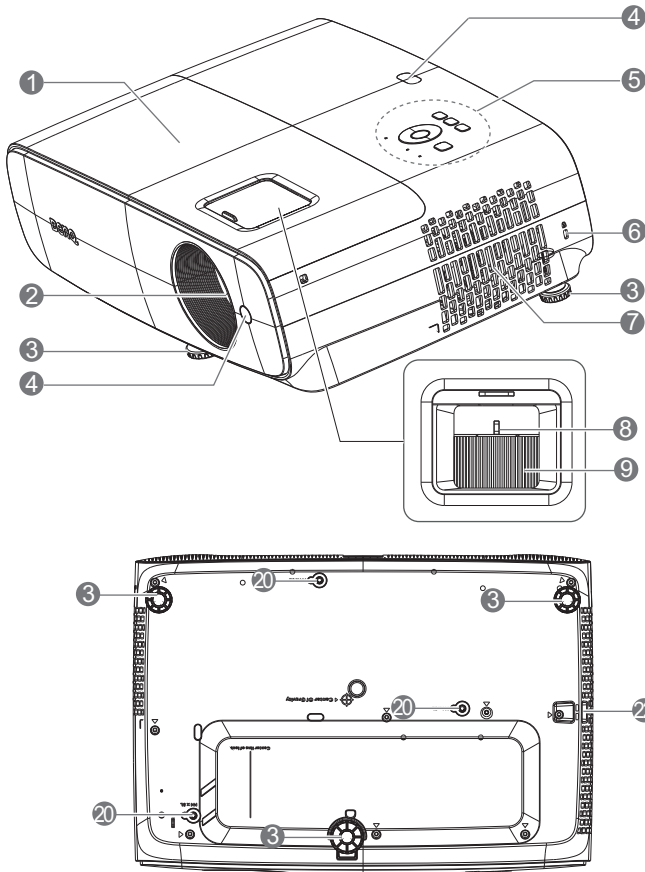

- 1. Lamp cover
- 2. Projection lens
- 3. Adjuster feet
- 4. IR remote sensor
- 5. External control panel
(See [Controls and functions on page 10.](#))
- 6. Kensington anti-theft lock slot
- 7. Vent (air inlet)
- 8. Zoom ring
- 9. Focus ring
- 10. Audio input jack
Audio output jack
- 11. RS-232 control port

- 12. RGB (PC) signal output jack
- 13. RGB (PC) signal input jacks
- 14. USB Mini-B port
- 15. HDMI I/ HDMI 2 input port
- 16. USB Type-A port (For Power Charging)
- 17. RJ45 LAN port (For LAN Control)
- 18. USB Type-A port (For USB Reader)
- 19. AC power jack
- 20. Wall mount holes
- 21. Vent (air exhaust)
- 22. Security bar
- 23. USB Type-A port (For USB Wi-Fi dongle)

Controls and functions







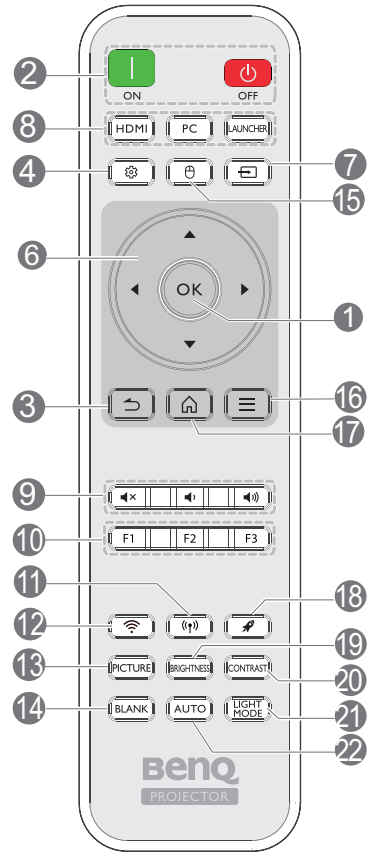
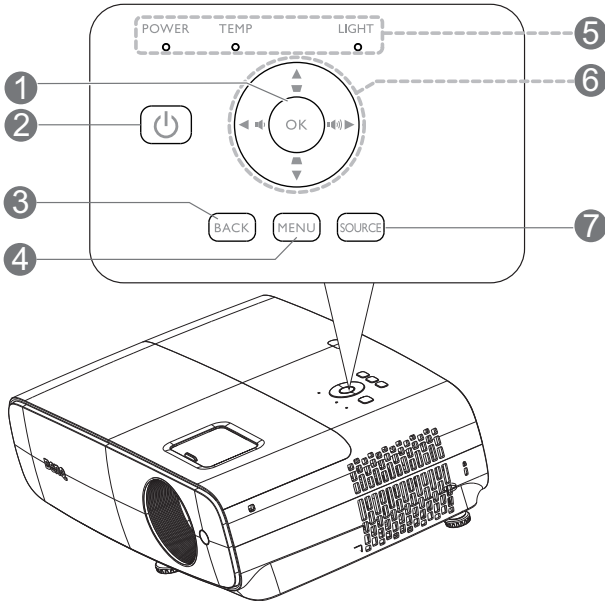



Projector & Remote control



• All the key presses described in this document are available on the remote control or projector.



No.		When the input source is BenQ Launcher	When the input source is NOT BenQ Launcher
1.	OK	Confirms the selected menu item.	Confirms the selected On-Screen Display (OSD) menu item.
2.	POWER ON/ Off	Toggles the projector between standby mode and on.	
3.	BACK (BACK)	Returns to the previous menu, main settings menu or exit the app.	Goes back to previous OSD menu or exits menu settings.
4.	MENU (MENU)	Enters the Settings menu.	Turns on or off the projector's On-Screen Display (OSD) menu.
5.	POWER indicator light/TEMPerature warning light/LIGHT indicator light	(See Indicators on page 61.)	

6.	Arrow keys (▲, ▼, ◀, ▶)	Moves through the menu items or toggle through the available options.	When the On-Screen Display (OSD) menu is activated, these keys are used as directional arrows to select the desired menu items and to make adjustments.
	Keystone keys (▲, ▼)	(Not available.)	Displays the keystone correction page.
	Volume keys (🔊 / 🔊)	(Not available.)	Decreases or increase the projector volume.
7.	SOURCE	Displays the source selection bar.	
	 (SOURCE)		
8.	Source selection buttons: HDMI, PC, LAUNCHER	Selects an input source for display.	
9.		Toggles projector audio between on and off.	
		Decreases the projector volume.	
		Increase the projector volume.	
10.	Control buttons: F1, F2, F3	Customizes buttons, the default is the entry interface of wireless projection (F1) / the entry interface of video conference (F2) / the entry interface of file manager (F3).	(Not available.)
11.	 (Hotspot)	Enters the Hotspot menu in Settings .	(Not available.)
12.	 (Wi-Fi)	Enters the Internet menu in Settings .	(Not available.)
13.	PICTURE	Selects an available picture mode.	
14.	BLANK	Used to hide the screen picture.  Do not block the projection lens from projecting as this could cause the blocking object to become heated and deformed or even cause a fire.	
15.	 (Cursor)	Activates the cursor function.	(Not available.)
16.	 (Smart Launcher Menu)	Goes to the BenQ Settings menu.	(Not available.)
17.	 (HOME)	Returns to the home screen.	(Not available.)
18.	 (Clear memory)	Goes into Task Manger.	(Not available.)
19.	BRIGHTNESS	Adjusts brightness.	
20.	CONTRAST	Adjusts contrast.	
21.	LIGHT MODE	Displays the Light Mode menu for selecting a suitable lamp operating mode.	
22.	AUTO	(Not available.)	Automatically determines the best picture timings for the displayed image when PC signal (analog RGB) is selected.

Remote control effective range

The remote control must be held at an angle within 40 degrees perpendicular to the projector's IR remote control sensor(s) to function correctly. The distance between the remote control and the sensor(s) should not exceed 8 meters (~ 26 feet).

Make sure that there are no obstacles between the remote control and the IR sensor(s) on the projector that might obstruct the infra-red beam.

- Operating the projector from the front
- Operating the projector from the top

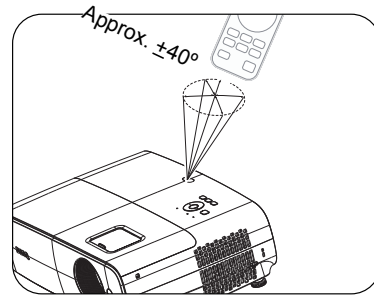
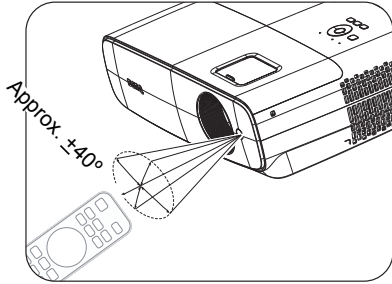

Positioning your projector

Choosing a location

Before choosing an installation location for your projector, take the following factors into consideration:

- Size and position of your screen
- Electrical outlet location
- Location and distance between the projector and the rest of your equipment

You can install your projector in the following ways.

1. Front Table

Select this location with the projector placed on the table in front of the screen. This is the most common way to position the projector for quick setup and portability.

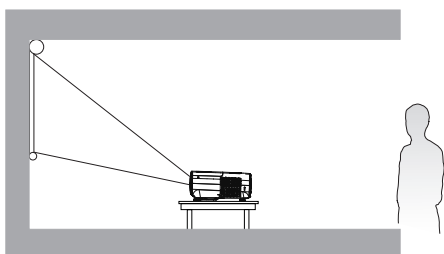

2. Rear Table

Select this location with the projector placed on the table behind the screen. Note that a special rear projection screen is required.

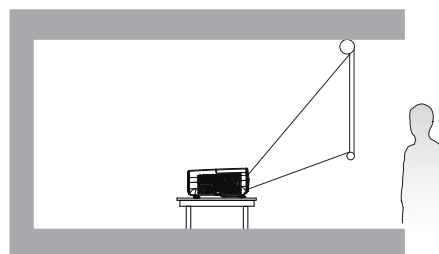

3. Front Ceiling

Select this location with the projector suspended upside-down in front of the screen. Purchase the BenQ Projector Ceiling/Wall Mount Kit from your dealer to mount your projector.

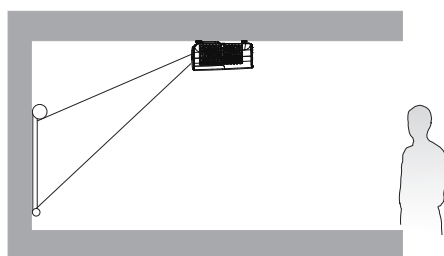

4. Rear Ceiling

Select this location with the projector suspended upside-down from behind the screen. Note that a special rear projection screen and the BenQ Projector Ceiling/Wall Mount Kit are required for this installation location.

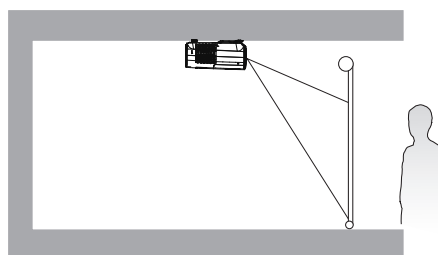

You can do one of the steps below to choose **Projector Position**:

1. If this is the first time you turn on the projector, the first step in setup wizard will guide you to select a setting.
2. When the input source is **BenQ Launcher**, go to **Settings > Display > Projector Position** and select a setting.
3. When the input source is not **BenQ Launcher**, go to **Advanced Menu - Settings > Projector Installation** and select a setting.

Obtaining a preferred projected image size

The distance from the projector lens to the screen, the zoom setting (if available), and the video format each factors in the projected image size.

Projection dimensions

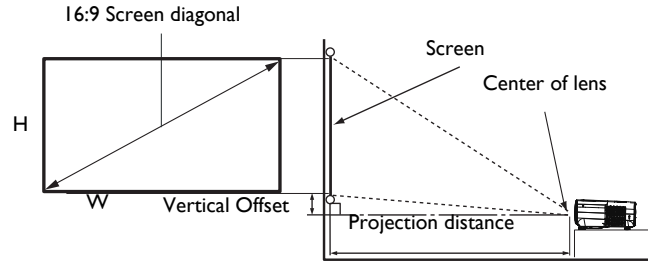

- The screen aspect ratio is 16:9 and the projected picture is in a 16:9 aspect ratio

Screen size				Distance from screen (mm)		
Diagonal		H (mm)	W (mm)	Min length	Average	Max length
Inch	mm			(max. zoom)		(min. zoom)
30	762	374	664	750	863	976
40	1016	498	886	1001	1151	1302
50	1270	623	1107	1251	1439	1627
60	1524	747	1328	1501	1727	1953
70	1778	872	1550	1751	2015	2278
80	2032	996	1771	2001	2302	2603
90	2286	1121	1992	2251	2590	2929
100	2540	1245	2214	2502	2878	3254
110	2794	1370	2435	2752	3166	3580
120	3048	1494	2657	3002	3454	3905
130	3302	1619	2878	3252	3741	4231
140	3556	1743	3099	3502	4029	4556
150	3810	1868	3321	3752	4317	4881
160	4064	1992	3542	4003	4605	5207
170	4318	2117	3763	4253	4893	5532
180	4572	2241	3985	4503	5180	5858
190	4826	2366	4206	4753	5468	6183
200	5080	2491	4428	5003	5756	6509
210	5334	2615	4649	5253	6044	6834
220	5588	2740	4870	5504	6331	7159
230	5842	2864	5092	5754	6619	7485
240	6096	2989	5313	6004	6907	7810
250	6350	3113	5535	6254	7195	8136
260	6604	3238	5756	6504	7483	8461
270	6858	3362	5977	6754	7770	8787
280	7112	3487	6199	7004	8058	9112
290	7366	3611	6420	7255	8346	9437
300	7620	3736	6641	7505	8634	9763

For example, if you are using a 120-inch screen, the recommended projection distance is 3454 mm.

If your measured projection distance is 5000 mm, the closest match in the "[Distance from screen \(mm\)](#)" column is 4893 mm. Looking across this row shows that a 170" (about 4.3 m) screen is required.



- All measurements are approximate and may vary from the actual sizes. BenQ recommends that if you intend to permanently install the projector, you should physically test the projection size and distance using the actual projector in situ before you permanently install it, so as to make allowance for this projector's optical characteristics. This will help you determine the exact mounting position so that it best suits your installation location.
- To optimize your projection quality, we suggest doing the projection by following the values in the non-gray cells.
- The values in the gray cells are for reference only.

Mounting the projector

If you intend to mount your projector, we strongly recommend that you use a proper fitting BenQ projector mounting kit and that you ensure it is securely and safely installed.

If you use a non-BenQ brand projector mounting kit, there is a safety risk that the projector may fall down due to an improper attachment through the use of the wrong gauge or length screws.

Before mounting the projector

- Purchase a BenQ projector mounting kit from the place you purchased your BenQ projector.
- BenQ recommends that you also purchase a separate Kensington lock compatible security cable and attach it securely to both the Kensington lock slot on the projector and the base of the mounting bracket. This will perform the secondary role of restraining the projector should its attachment to the mounting bracket become loose.
- Ask your dealer to install the projector for you. Installing the projector on your own may cause it to fall and result in injury.
- Take necessary procedures to prevent the projector from falling off such as during an earthquake.
- The warranty doesn't cover any product damage caused by mounting the projector with a non-BenQ brand projector mounting kit.
- Consider the surrounding temperature where the projector is ceiling/wall mounted. If a heater is used, the temperature around the ceiling/wall may be higher than expected.
- Read the user manual for the mounting kit about the range of torque. Tightening with torque exceeding the recommended range may cause damage to the projector and subsequently falling off.
- Make sure the power outlet is at an accessible height so that you can easily shut down the projector.

Ceiling/Wall mount installation diagram

Ceiling/Wall mount screw: M4
(Max L = 25 mm; Min L = 20 mm)

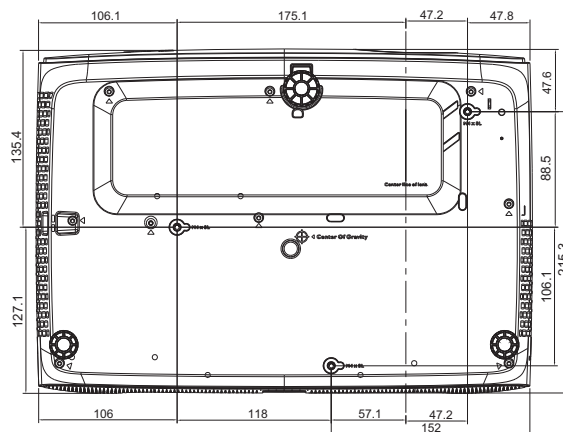

Unit: mm

Adjusting the projected image

Adjusting the projection angle

If the projector is not placed on a flat surface or the screen and the projector are not perpendicular to each other, the projected image becomes trapezoidal. You can screw the adjuster feet to fine-tune the horizontal angle.

To retract the feet, screw the adjuster feet in a reverse direction.

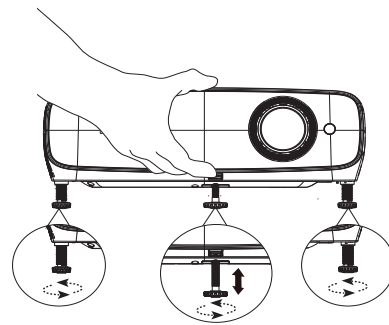

! Do not look into the lens while the lamp is on. The strong light from the lamp may cause damage to your eyes.

Fine-tuning the image size and clarity

Adjust the projected image to the size that you need using the zoom ring.

Sharpen the image by rotating the focus ring.

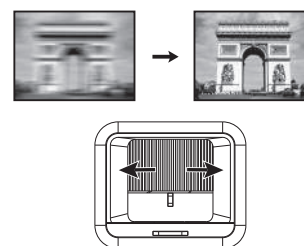
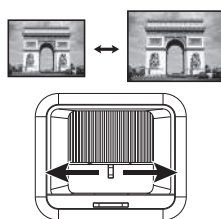

Correcting keystone

Keystoning refers to the situation where the projected image becomes a trapezoid due to angled projection.

To correct this, make sure that the input source is NOT **BenQ Launcher** and **Auto Vertical Keystone** is **Off**.

Press ▲ / ▼ on the remote control or ▲ / ▼ on the projector to display the Keystone correction page. Press ▼ to correct keystoning at the top of the image. Press ▲ to correct keystoning at the bottom of the image. When Keystone OSD pops up, long press **OK** for 2 seconds to enable Auto



V-Keystone. When Keystone OSD pops up, long press  (**BACK**) for 2 seconds to reset Keystone.

Connection

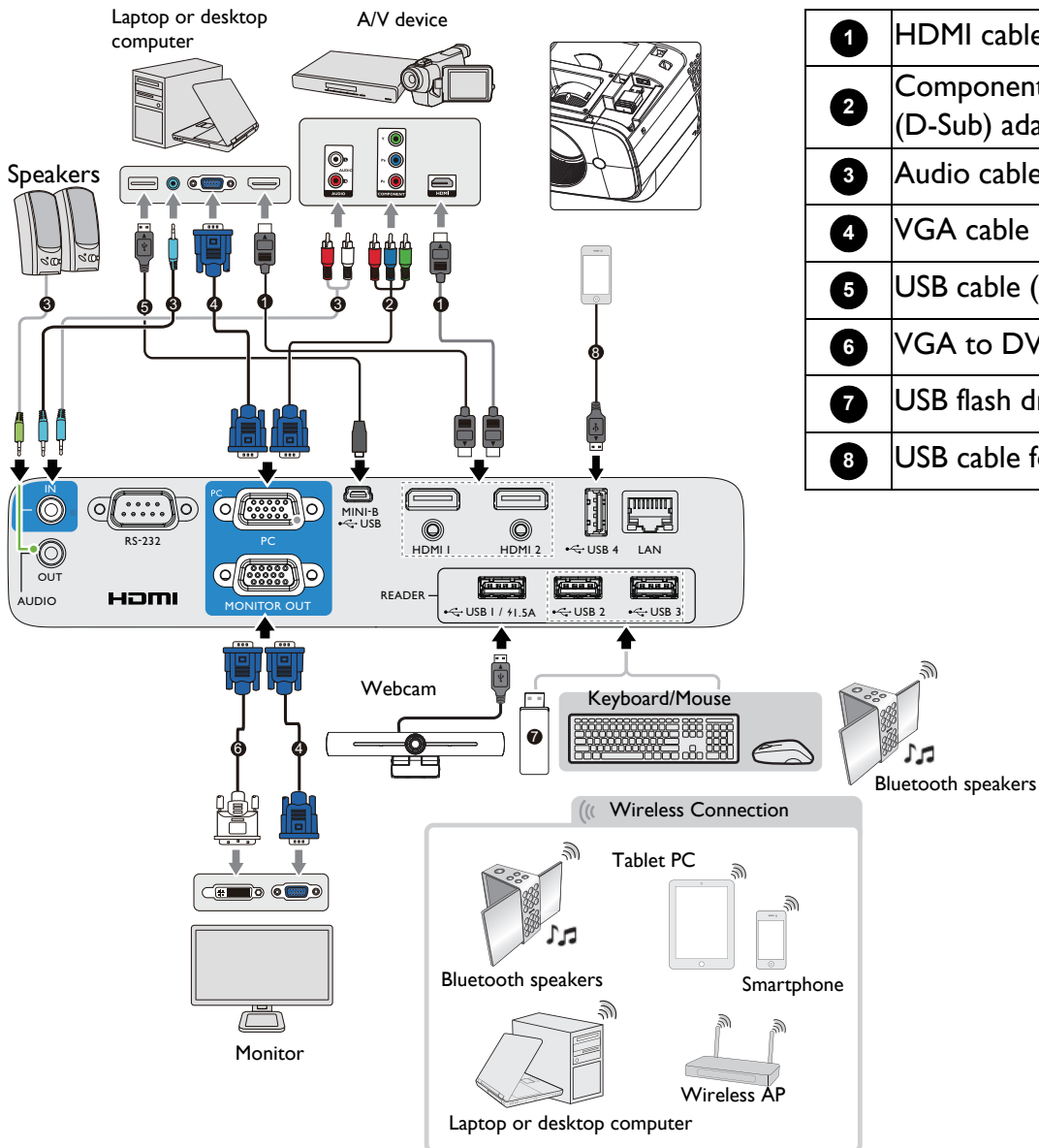

When connecting a signal source to the projector, be sure to:

1. Turn all equipment off before making any connections.
2. Use the correct signal cables for each source.
3. Ensure the cables are firmly inserted.







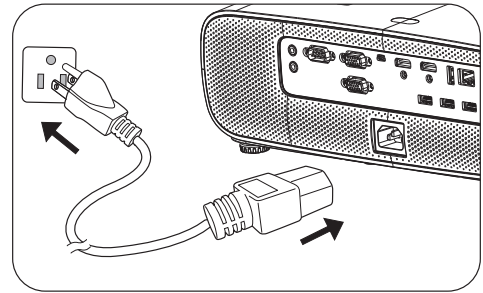

- In the connections above, some cables may not be included with the projector (see [Shipping contents on page 7](#)). They are commercially available from electronics stores.
- The connection illustrations are for reference only. The rear connecting jacks available on the projector vary with each projector model.
- Many notebooks do not turn on their external video ports when connected to a projector. Usually a key combo like FN + function key with a monitor symbol turns the external display on/off. Press FN and the labeled function key simultaneously. Refer to your notebook's documentation to find your notebook's key combination.
- If the selected video image is not displayed after the projector is turned on and the correct video source has been selected, check that the video source device is turned on and operating correctly. Also check that the signal cables have been connected correctly.

Starting up the projector

1. Plug the power cord. Turn on the power outlet switch (where fitted). The power indicator on the projector lights orange after power has been applied.
2. Press  on the projector or  on the remote control to start the projector. The power indicator flashes green and stays green when the projector is on. The start up procedure takes within one minute. In the later stage of start up, a startup logo is projected.
(If necessary) Rotate the focus ring to adjust the image clearness.



- Please use the original accessories (e.g. power cord) to avoid possible dangers such as electric shock and fire.
 - If the projector is still hot from previous activity, it will run the cooling fan for approximately 90 seconds before energizing the lamp.
3. If this is the first time you turn on the projector, the setup wizard appears to guide you through setting up the projector. If you have already done this, skip this step and move on to the next step.
 - Use the arrow keys (, , , ) on the projector, remote control or plug in mouse to control and move through the menu items.
 - Use **OK** to confirm the selected menu item.
 - Use the back button  (**BACK**) to return to the previous menu.
 - Use the menu button  to skip a menu.

 The Setup Wizard screenshots are for reference only and may differ from the actual design.

If the Wi-Fi dongle is not plugged, follow the instructions on the screen to install it.



Step 1:
Select **Language**.



Step 2:
Select **Projector Position**.



Step 3:
Adjust **Keystone**.

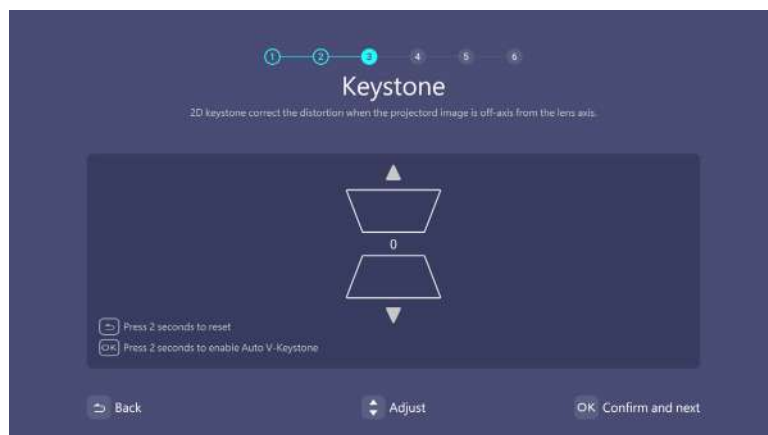

Step 4:

Connect to a Wi-Fi network by selecting the wireless network and entering the password.

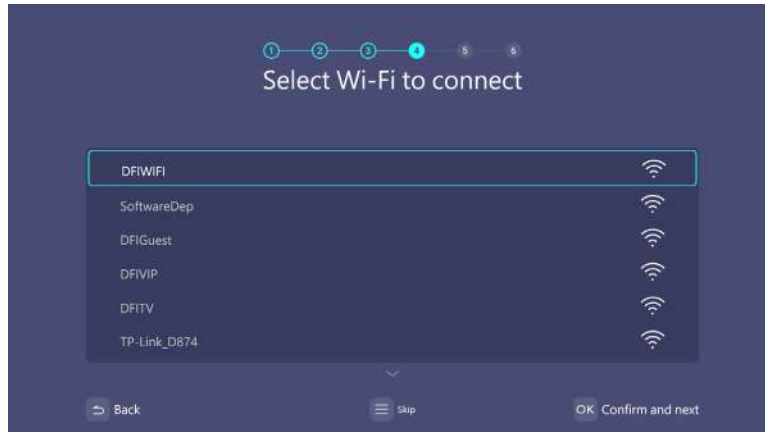

Step 5:

Select **Time Zone**.



Step 6:

Read **Privacy Policy** and press **OK**.

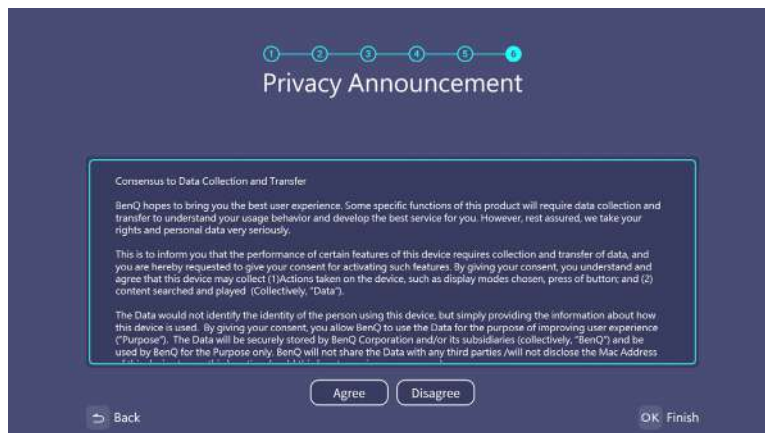

Install Windows operating system.

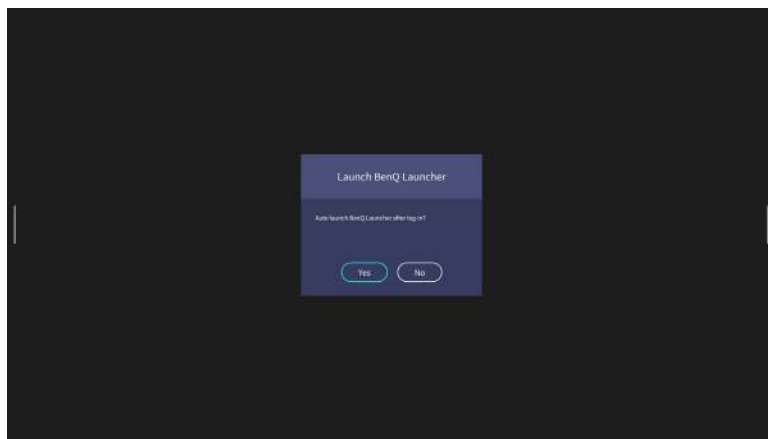



- Do not power off during the installation process; otherwise, Windows operating system will be damaged.
- A pop-up menu will appear to ask whether users want to enter windows or launcher interface process.

BenQ Launcher home screen will appear after the installation is completed.

- You can use a USB mouse to navigate BenQ Launcher and operate its function.

Now you have two ways to work with this projector. Different operations are required depending on your needs.

Scenarios	Available functions	Operations
Access BenQ Launcher	BenQ Launcher functions: <ul style="list-style-type: none"> • Wireless Projection • Conference • File manager • Apps • HID (Human Interface Device) connectivity (e.g., mouse and keyboard connection) 	Press the LAUNCHER on the remote control or  (SOURCE) and select BenQ Launcher .

Traditional projector	Wired projection only, without HID connectivities	Press the HDMI or PC on the remote control or  (SOURCE) and select HDMI 1 or HDMI 2 or PC/YPbPr .
-----------------------	---	--

Operation (under Launcher source)

BenQ Launcher

BenQ Launcher is the projector's operating system that allows you to wirelessly cast your device's screen, play files, run apps, as well as adjust projector settings.

- Use the buttons on the projector, the remote control, or connect a USB mouse to the projector's **USB 1** or **USB 2** or **USB 3** ports to navigate BenQ Launcher and operate its functions.

BenQ Launcher home screen

Upon initial start up or when **BenQ Launcher** is selected in the input source menu, the projector will display **BenQ Launcher**. If the projector is projecting from an input source (e.g. **HDMI 1** or **HDMI 2 PC/YPbPr**), you can return to **BenQ Launcher** mode by pressing the source button or the **LAUNCHER** button on the remote control and then selecting **BenQ Launcher** in the input source menu.

- When the **Auto Source Search** function is enabled in the **Advanced > Settings** menu of the projector's OSD menu, the projector will detect if a signal is available from the input source that was last used and switch to that input source if it is available, if a signal is not available, the projector will display **BenQ Launcher/Windows Interface** based on the previous settings preference.
- If the **Auto Source Search** function is off, the projector will display the source that was last used.

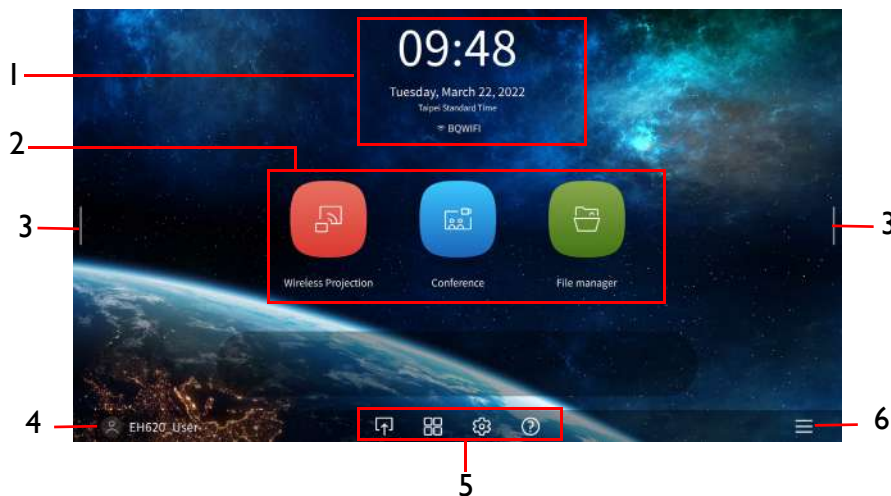

- Actual screen may vary based on your **BenQ Launcher** firmware version.

BenQ Launcher home screen features six main components:

No.	Component	Description
1	Status Bar	Icons that display the time, Bluetooth, wireless status, and device name.
2	Main Menu	Shortcuts to instructions on how to project wirelessly, start a video Conference, and access files stored on File Manager. See Using the Main Menu on page 26 for more information.
3	Sidebar	A menu of quick navigation buttons. See Using the sidebar on page 26 for more information.
4	User account	Allows you to manage your account settings.
5	Toolbar	Buttons for the input source, all apps, and Settings menu. See Using the Toolbar on page 27 for more information.
6	Quick Settings	Settings for Windows desktop mode, Internet, Bluetooth, Connect, and Auto Launch.



Press the down button to access the Source menu, App shortcuts, Settings menus and Information.

Navigating the BenQ Launcher home screen

1. From the BenQ Launcher home screen, press ▲/▼/◀/▶ to select the desired function and press **OK**.
2. Follow on-screen instructions for further operations.

Inputting text

Various menus within BenQ Launcher may require that you input text. You may either connect a keyboard to the **USB 1** or **USB 2** or **USB 3** port at the rear of the projector or follow the steps below:

1. Select the text field where you want to input text.
2. Press ▲/▼/◀/▶ to navigate the keyboard, and press **OK** to select the letter/key/symbol you want to enter into the text field.
3. Press the back button at anytime to exit out of the keyboard.



Actual keyboard types may vary based on your language preference setting.

Using the Main Menu

The Main Menu includes buttons to access the following functions:

- Wireless Projection - Instructions on projecting from your a MAC, PC, iOS, Android device. See [Wireless Connections on page 28](#) for more details on projecting wirelessly.
- Conference - Starting a video conference with the built-in apps for big screen projection.
- File manager - Opening the Windows File Manager screen.



Using the sidebar

For situations where the projector is out of the reach of the user (for example, when the projector is mounted on the ceiling) and as a result the buttons on the projector are not accessible, **BenQ Launcher** features sidebars on both the left and right side of the screen that can be called out at anytime to access a set of virtual buttons. To call out the sidebar on a screen, click the arrow buttons on the left or right side of the screen.

-  An HID-protocol device (e.g. a mouse) must be connected to the projector to be able to use the side bar



The following buttons are included in the sidebar:





Button	Description
Home	Select to return to the BenQ Launcher home screen.
Volume	Select to display volume adjustment bar.
TaskView	Select to edit the recently used files on Windows.
Source	Select to switch the input source.
Update	Select to set update notification.

Using the Toolbar

The tool bar features buttons to access the input source menu, the all apps menu, and the Settings menu.



Toolbar

Button	Description
	Select to open the input source menu.
	Select to open the all apps menu. See All Apps on page 37 for more details on the all apps menu.
	Select to open the Settings menu. See About the Settings menu on page 36 for more information on the Settings menus
	Select to open the Info menu to display user manual QR code and videos.

Switching input signal

When **HDMI 1**, **HDMI 2** or **PC/YPbPr** is selected in the source menu, the projector will exit the **BenQ Launcher** interface to project video from the input source (e.g. a Blu-Ray/DVD player, set-top box, or PC). The projector will remain outside of the **BenQ Launcher** interface as long as the **HDMI 1**, **HDMI 2** or **PC/YPbPr** input source is selected or (depending on Auto Source settings) until the projector is powered off and back on again.

As a result, anytime the user wants to wirelessly cast their device's screen, they must return to the **BenQ Launcher** interface. To return to **BenQ Launcher**:

1. Press the  (**SOURCE**) button or the **LAUNCHER** button on the remote control.
2. Select **BenQ Launcher** in the source menu.

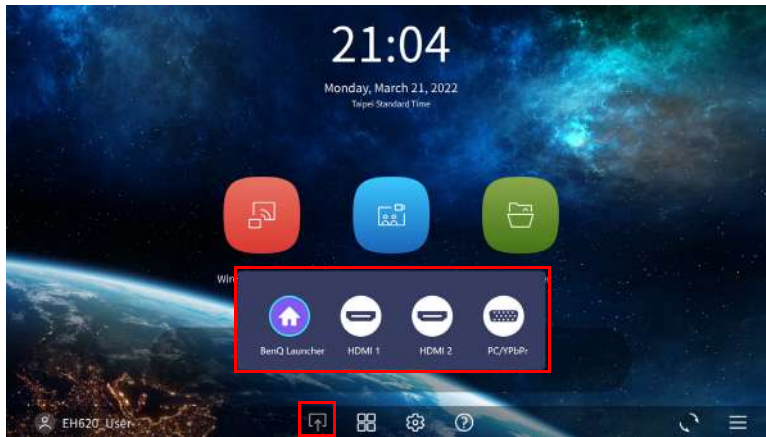

Wireless Connections

Connecting the projector to a wireless network

Before you can project wirelessly via the projector, you must connect your device to the same wireless network as your projector. To connect your projector to a wireless network, or to switch wireless networks:

-  If you have already connected the projector to a wireless network during the setup wizard you may skip the steps in this section
- 1. Install the provided wireless dongle into the wireless dongle port (see [Installing the USB Wi-Fi dongle on page 8](#)).
- 2. Power on the projector (see [Starting up the projector on page 19](#))
- 3. On the home screen of the **BenQ Launcher** interface select the **Settings** button and press **OK**.



- 4. Select **Internet** in the **General** section of the **Settings** menu and then press **OK**.

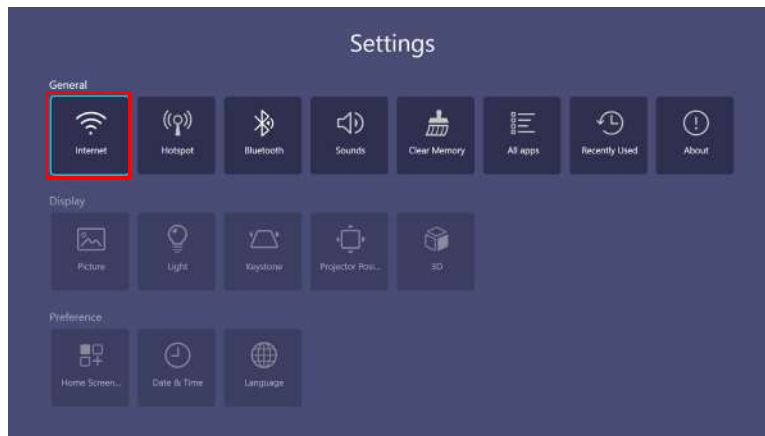

5. Select **Wireless Network Setting** and press **OK** to enable.



6. Select the SSID for the wireless AP you want to connect to and press **OK**.

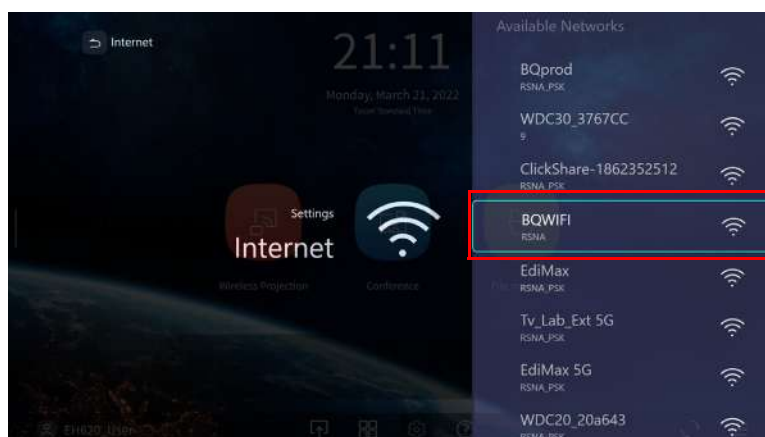

- To connect to a hidden wireless network select Add A Network and enter the SSID, security setting, and password for the network.
- The list of available wireless networks will be refreshed every 10 seconds. If the desired SSID is not listed please wait for refreshing to complete.

7. If you chose a secured SSID for the first time, a window appears prompting you to enter the appropriate password. Use the virtual keypad to enter the password. After you have entered the password, select **Next** and the projector will automatically connect.



- The password will be stored in the projector's memory. In the future, if you select the same SSID again, you will not be prompted to enter a password unless you delete the SSID from the projector's memory.
- If the password is typed incorrectly, you can select either re-enter the password or press the  (**BACK**) button to return to the list of SSIDs.

8. Once you have successfully connected to the wireless AP, a wireless connection icon will appear at the top of the **BenQ Launcher** interface. You can now connect your devices wirelessly to the projector to cast your device's screen.



9. Click Wireless Projection and turn on "Mirroring & Controlling" button from Wireless Projection Settings interface.

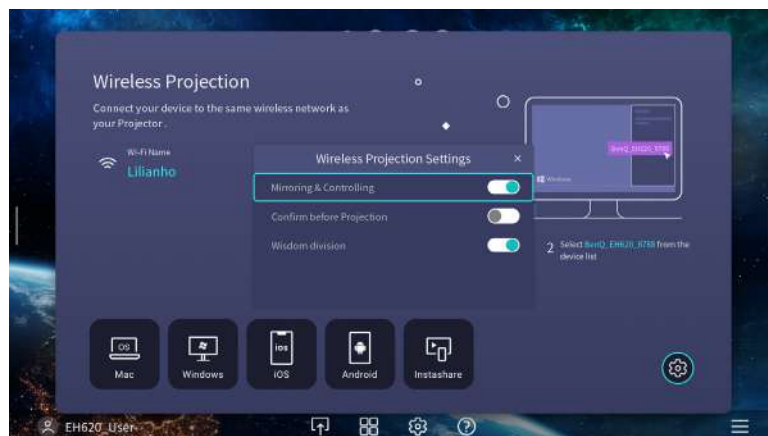

Wireless Hotspot

In situations where the projector is out-of-range of a wireless network (for example while on a camping trip), you can configure the projector to act as a wireless hotspot to create a closed network for devices to connect directly to the projector via a wireless connection and to project files from their local storage.



- The projector will have no access to the Internet while in wireless hotspot mode.

To create a wireless hotspot:

1. Install the wireless dongle into the wireless dongle port (see [Installing the USB Wi-Fi dongle on page 8](#)).
2. Power on the projector (see [Starting up the projector on page 19](#)).
3. On the home screen of the **BenQ Launcher** interface select the **Settings** button and press **OK**.

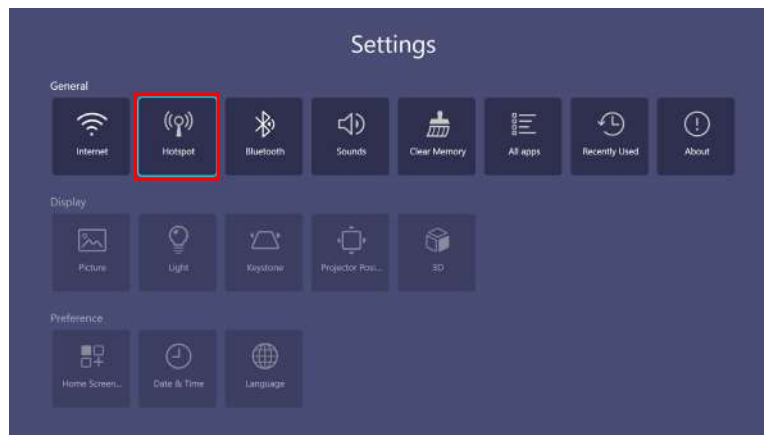

4. Select **Hotspot** and press **OK**.

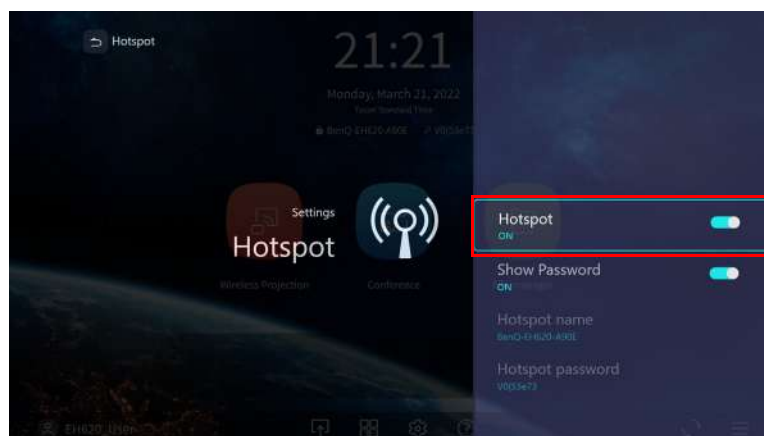

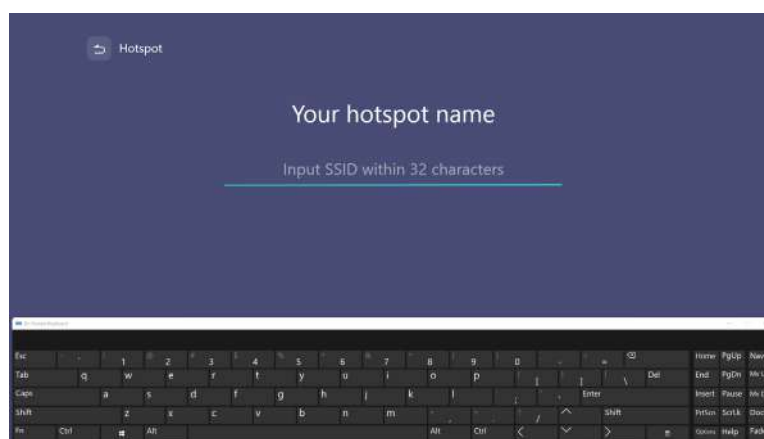

5. (Optional) Select **Hotspot Name** and/or **Hotspot Password** and press **OK** to change the name and/or password of the wireless hotspot.

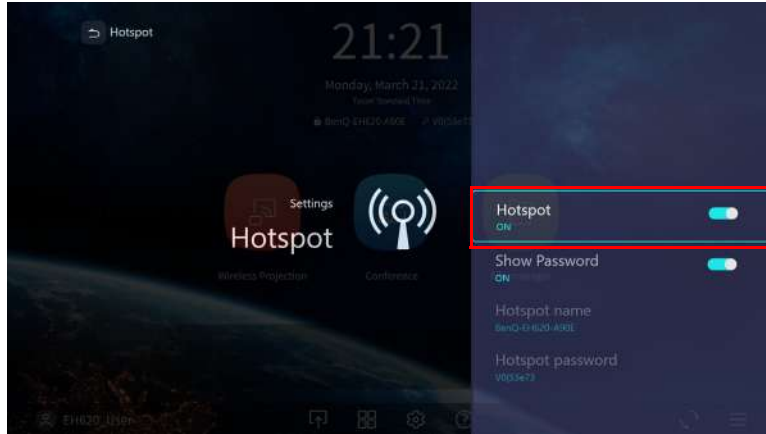

 You can only change the **Hotspot Name** and **Hotspot Password** when **Hotspot** is disabled.

6. Select **Hotspot** and press **OK** to enable wireless hotspot.



 The projector will have no access to the Internet while in wireless hotspot mode.

7. Once wireless hotspot is enabled, use the name shown in the **Hotspot Name** field as the SSID to connect to from your mobile device's wireless menu and use the password shown in the **Hotspot Password** field as the connection password.

Bluetooth Connections

The projector is able to connect to a Bluetooth-enabled speaker or headphones to output audio directly for greater sound, particularly in outdoor settings.



- The Bluetooth connection does not support any data transfer as the projector only allows Bluetooth connections for audio output.
- You may not use the projector to broadcast audio from a Bluetooth-enabled mobile device.

Pairing/Connecting to a Bluetooth speaker or headphones

Pairing is the process by which your projector creates a connection to a Bluetooth speaker or headphones for the first time. Once both devices have been successfully paired each device will have the corresponding device's pairing information stored internally and both will be able to connect automatically when they are within an ~5 meter range of each other and Bluetooth is enabled on the projector.

To pair your projector to a Bluetooth speaker or headphones:

1. Install the provided wireless dongle into the wireless dongle port (see [Installing the USB wireless dongle on page 17](#)).
2. Power on the projector (see [Starting up the projector on page 19](#)).
3. On the home screen of the **BenQ Launcher** interface select the **Settings** button and press **OK**.



4. Select **Bluetooth** and press **OK**.

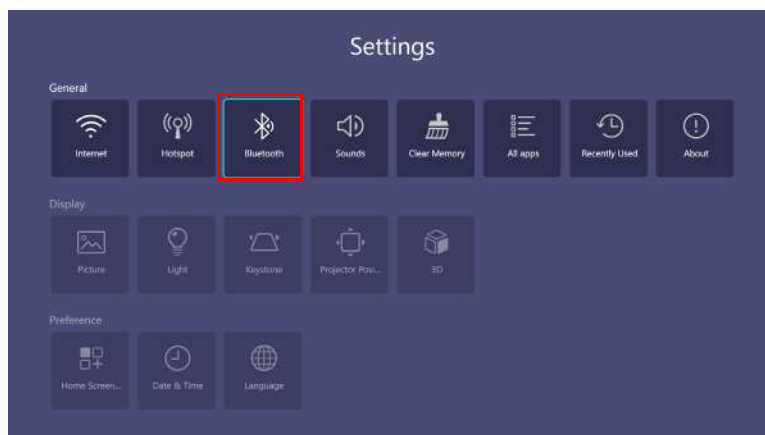

5. Select **Bluetooth** and press **OK** to enable Bluetooth.

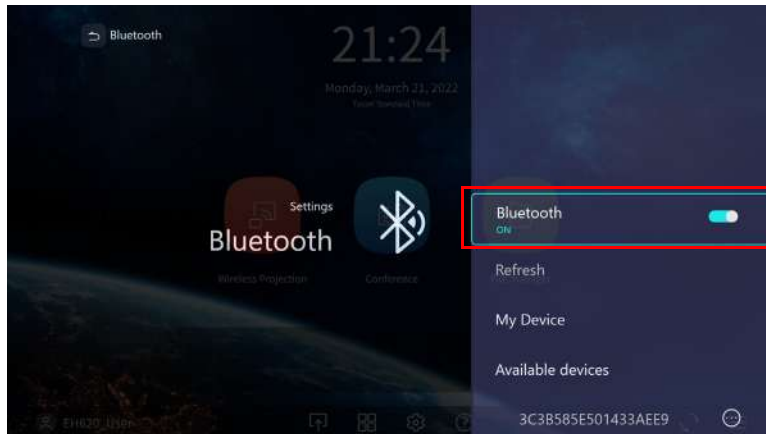

6. Activate Bluetooth-pairing mode on the speaker or headphones.
7. Select the speaker or headphones from the **Device List** in the **Bluetooth** setting menu and press **OK**.

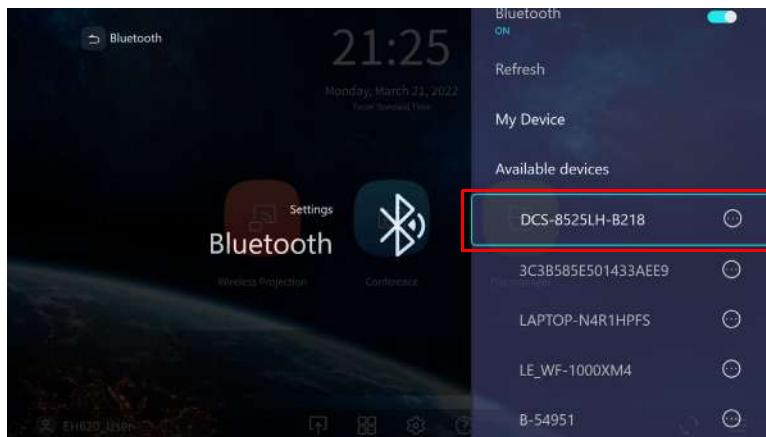

8. When the projector and speaker or headphones have successfully connected the device listing in the Bluetooth setting menu will be labeled **Connected**, you can now output the audio from the projector to the speaker or headphone.

Once you have successfully paired your projector with the Bluetooth speaker, pairing information will be stored on both devices and a connection will automatically be made when Bluetooth is enabled on both devices and both devices are within range of each other.



- If you replace the wireless dongle on your projector anytime after you have paired your projector with a Bluetooth device you will need to re-pair your projector to the device in order to create a Bluetooth connection.
- The quality of the Bluetooth transmission may depend on the quality of the Bluetooth signal along with the compatibility of the mobile device.

Ending the Bluetooth connection

In cases where you want to disconnect a speaker or headphones from the projector and connect to another speaker or headphones follow the steps below:

1. On the home screen of the **BenQ Launcher** interface select the **Settings** button and press **OK**.
2. Select **Bluetooth** and press **OK**.

3. Select the already connected speaker or headphones from the **Device List** in the **Bluetooth** setting menu and press **OK**.
4. Confirm that you want to disconnect the speaker or headphones from the projector.
5. Activate Bluetooth-pairing mode on the new speaker or headphones.
6. Select the new speaker or headphones from the **Device List** in the **Bluetooth** setting menu and press **OK**.

Deactivating the Bluetooth speaker or headphones

To deactivate Bluetooth on the projector so that it no longer outputs its audio to a separate speaker or headphones:

1. On the home screen of the **BenQ Launcher** interface select the **Settings** button and press **OK**.
2. Select **Bluetooth** and press **OK**.
3. Select **Bluetooth** and press **OK** to disable Bluetooth.

Navigating the Settings

About the Settings menu

To let you make various adjustments or settings on the projector, its wireless connections, and the projected image, **BenQ Launcher** provides a **Settings** menu. To access the **Settings** menu, in the **BenQ Launcher** home screen select the **Settings** button.



The following is the **Settings** menu:

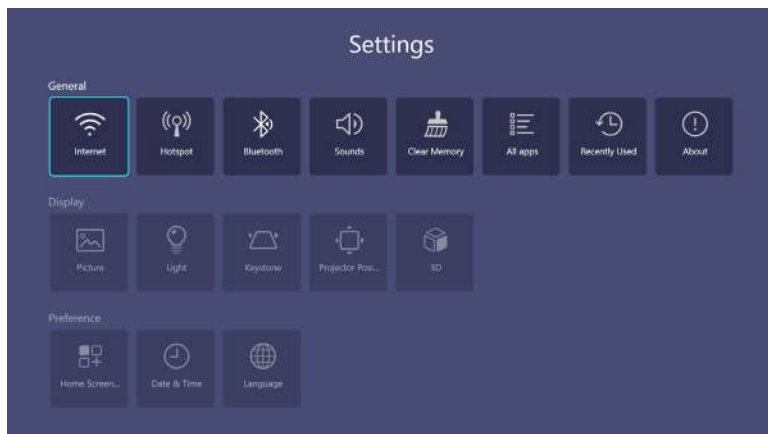



Using the Settings



To access the various settings menus:

- Use the left and right arrow keys (◀/▶) to move through the main **Settings** menus.
- Use **OK** to select the desired menu.

When configuring items within a menu:

- Use the up and down arrow keys (▲/▼) to move to the item you want to configure.
- Use left and right arrow keys (◀/▶) to toggle through the available options.
- Use **OK** to enable/disable options or select sub-menu options.
- Use the  (**BACK**) button to return to the main settings menu.
- Use the  (**HOME**) button to return to **BenQ Launcher** home page.

General

<p>Internet</p>	<ul style="list-style-type: none"> • Wireless Network Setting: Enables Wireless Network Setting for the projector. See Connecting the projector to a wireless network on page 28. • Speed Test: Tests the speed of the projector's Internet connection. • Diagnosing: Diagnoses the status of the projector's Internet connection. • Add Network: Allows you to add a specific network that may be hidden or undetected in the Available Networks. Once selected you will be prompted to enter the SSID and security settings for the network. • Available Networks: Lists the available wireless access points which the projector can connect to. See Connecting the projector to a wireless network on page 28.  <ul style="list-style-type: none"> • The Available Networks is only available when Wireless Network Setting is enabled.
<p>Hotspot</p>	<ul style="list-style-type: none"> • Hotspot: Enables or disables hotpost. See Wireless Hotspot on page 30. • Show Password: Enables or disables to show the password of the projector's wireless network hotspot when security is set to WPA/WPA2 PSK. • Hotspot Name: Displays the name for the projector's wireless network hotspot, which appears in the wireless network list for devices looking to connect directly to the projector. • Hotspot Password: Shows or hides Hotspot Password.
<p>Bluetooth</p>	<ul style="list-style-type: none"> • Bluetooth: Enables Bluetooth for the projector, allowing the projector to output its audio to a Bluetooth speaker or headphones. • Refresh: Refreshes the list of devices. • My Device: Lists of previously paired Bluetooth devices. • Available Device: Lists the available Bluetooth devices which the projector can pair and connect to.  <p>Refresh, My Device, Available Device are only available when Bluetooth is enabled.</p>
<p>Sounds</p>	<ul style="list-style-type: none"> • Sound Mode: Utilizes sound enhancement technology to deliver great effects of the bass and treble and provide you with immersive cinematic audio experience. The following preset sound modes are provided: Vocal Mode, Cinema Mode, and Music Mode. • Volume: Adjusts the sound level. • Mute: Temporarily turns off the sound.
<p>Clear Memory</p>	<p>Clears out the memory of unnecessary files and boosts available RAM.</p>
<p>All Apps</p>	<p>Access all the apps that have been installed on the projector.</p>
<p>Recently Used</p>	<p>View recently used files in Windows.</p>

About

- **Projector Information:** Displays information on the current status of the projector including the current **Device Name, Native Resolution, Picture Mode, Light Mode, Sound Mode, Light Usage Time, Firmware Version,** and **Service Code.**
- **Wintel System Information:** Displays information on the current status of the Wintel System including the current **Wintel Version, Ram, System storage, Internal storage, MAC Address.**
- **BenQ Launcher Update Options:** Allows you to set Windows Auto Update, BenQ Launcher Auto Update, and USB update. When a new version is available, a message will pop up once the projector is connected to a wireless network.
- **Privacy Announcement:** Allows you to view and accept or reject BenQ's privacy policy.
- **Reset All Settings:** Returns all settings to the factory preset values and then go to Setup Wizard installation.

Display

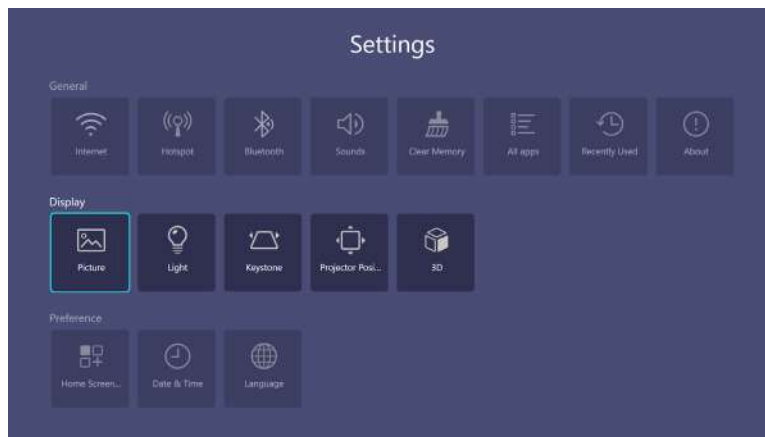

Picture	See Advanced menu on page 45 for the Picture settings options.
Light	See Advanced menu on page 45 for the Light Settings settings options.
Keystone	See Advanced menu on page 45 for the Keystone settings options
Projector Position	See Advanced menu on page 45 for the Projector Position settings options.
3D	See Advanced menu on page 45 for the 3D settings options.

Preference

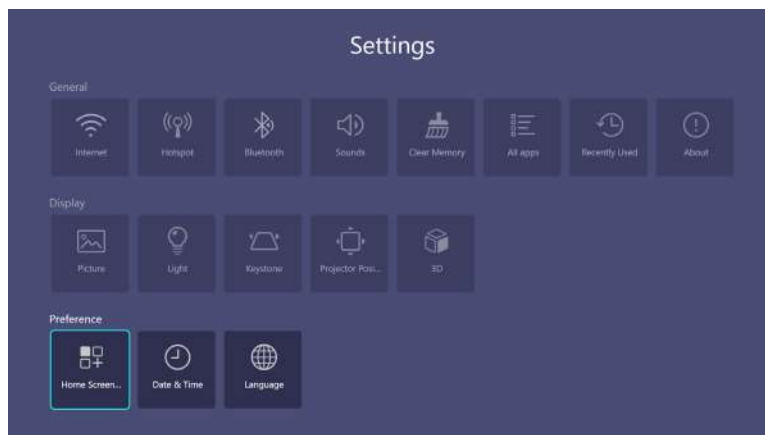

Home Screen Settings	Allows you to edit Shortcut or Settings displayed in BenQ Launcher home page.
Date & Time	<ul style="list-style-type: none"> • Time Zone: Sets the time zone for the projector. • Format: Sets the date and time format.
Language	Sets the language of the system.

Operation (under non-Launcher source)

Using the projector menus under non-Launcher source

When the input signal is **HDMI 1** **HDMI 2** or **PC/YPbPr**, you can use 2 types of On-Screen Display (OSD) menus for making various adjustments and settings.

- **Basic** OSD menu: provides primary menu functions. (See [Basic menu on page 43](#))
- **Advanced** OSD menu: provides full menu functions. (See [Advanced menu on page 45](#))

To access the OSD menu, press  (**MENU**).



- Use the arrow keys (**▲/▼/◀/▶**) on the projector or remote control to move through the menu items.
- Use **OK** on the projector or remote control to confirm the selected menu item.

The first time you use the projector (after finishing the initial setup), **Basic** OSD menu displays.

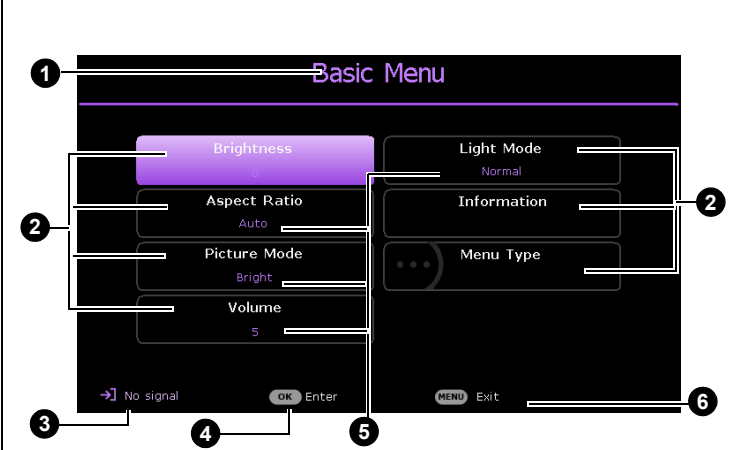

The OSD screenshots below are for reference only, and may differ from the actual design.

Below is the overview of the **Basic** OSD menu.

	1 Menu Type	4 Press OK to enter the menu.
	2 Main menu	5 Status
	3 Current input signal	6 Press  (MENU) to go to the previous page or to exit.

If you intend to switch from the **Basic** OSD menu to the **Advanced** OSD menu, follow the instructions below:

1. Go to **Basic Menu > Menu Type**.
2. Press **OK** and press **▲/▼** to select **Advanced**. Next time when you turn on the projector, you may access the **Advanced** OSD menu by pressing  (**MENU**).

Below is the overview of the **Advanced** OSD menu.

1	Main menu & Main menu icon	5	Press (BACK) to go to the previous page.
2	Sub-menu	6	Press (MENU) to go to the previous page or to exit.
3	Current input signal	7	Status
4	Press OK to enter the menu.		

Likewise, when you wish to switch from the **Advanced** OSD menu to the **Basic** OSD menu, follow the instructions below:

1. Go to **Advanced Menu - System > Menu Settings** and press **OK**.
2. Select **Menu Type** and **OK**.
3. Press **▲/▼** to select **Basic**. Next time when you turn on the projector, you may access the **Basic** OSD menu by pressing (**MENU**).

Securing the projector

Using a security cable lock

The projector has to be installed in a safe place to prevent theft. Otherwise, purchase a lock, such as the Kensington lock, to secure the projector. You can locate a Kensington lock slot on the rear side of the projector. See item 6 on [page 9](#).

A Kensington security cable lock is usually a combination of key(s) and the lock. Refer to the lock's documentation for finding out how to use it.

Utilizing the password function

Setting a password

1. Go to **Advanced Menu - Settings > Security Settings**. Press **OK**. The **Security Settings** page appears.
2. Highlight **Change Password** and press **OK**.
3. The four arrow keys (**▲**, **▶**, **▼**, **◀**) respectively represent 4 digits (1, 2, 3, 4). According to the password you desire to set, press the arrow keys to enter six digits for the password.
4. Confirm the new password by re-entering the new password. Once the password is set, the OSD menu returns to the **Security Settings** page.
5. To activate the **Power On Lock** function, press **▲/▼** to highlight **Power On Lock** and press **◀/▶** to select **On**. Input the password again.

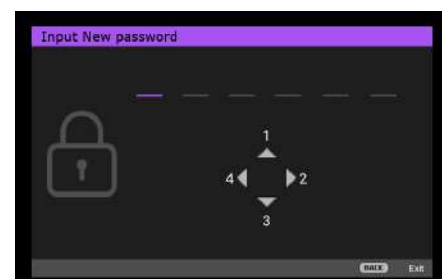



- The digits being input will display as asterisks on-screen. Make a note of your selected password and keep it in a safe place in advance or right after the password is entered so that it is available to you should you ever forget it.
- Once a password has been set and the power on lock is activated, the projector cannot be used unless the correct password is entered every time the projector is started.

If you forget the password

If you enter the wrong password, the password error message will appear, and the **Input Current Password** message follows. If you absolutely do not remember the password, you can use the password recall procedure. See [Entering the password recall procedure on page 42](#).

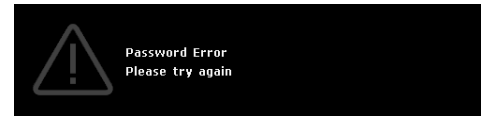

If you enter an incorrect password 5 times in succession, the projector will automatically shut down in a short time.

Entering the password recall procedure

1. Press and hold **AUTO** for 3 seconds. The projector will display a coded number on the screen.
2. Write down the number and turn off your projector.
3. Seek help from the local BenQ service center to decode the number. You may be required to provide proof of purchase documentation to verify that you are an authorized user of the projector.

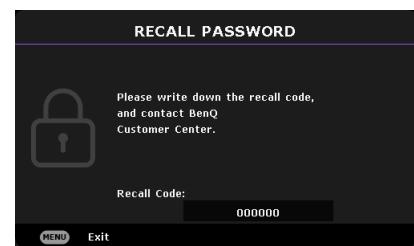

Changing the password

1. Go to **Advanced Menu - Settings > Security Settings > Change Password**.
2. Press **OK**. The message **“Input Current Password”** appears.
3. Enter the old password.
 - If the password is correct, another message **“Input New Password”** appears.
 - If the password is incorrect, the password error message will appear, and the message **“Input Current Password”** appears for your retry. You can press **BACK** to cancel the change or try another password.
4. Enter a new password.
5. Confirm the new password by re-entering the new password.

Disabling the password function

To disable password protection, go to **Advanced Menu - Settings > Security Settings > Power On Lock** and press **◀/▶** to select **Off**. The message **“Input Current Password”** appears. Enter the current password.

- If the password is correct, the OSD menu returns to the **Security Settings** page. You will not have to enter the password next time turning on the projector.
- If the password is incorrect, the password error message will appear, and the message **“Input Current Password”** appears for your retry. You can press **BACK** to cancel the change or try another password.







Though the password function is disabled, you need to keep the old password in hand should you ever need to re-activate the password function by entering the old password.

Menu operation

Please note that the on-screen display (OSD) menus vary according to the signal type selected and the projector model you are using.

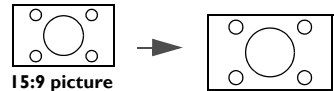
The menu items are available when the projector detects at least one valid signal. If there is no equipment connected to the projector or no signal detected, limited menu items are accessible.

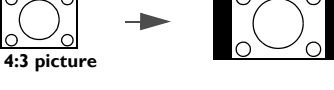
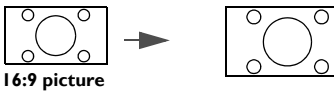
Basic menu

<p>Brightness</p>	<p>The higher the value, the brighter the image. Adjust this control so the black areas of the image appear just as black and that detail in the dark areas is visible.</p>
<p>Aspect Ratio</p>	<p>There are several options to set the image's aspect ratio depending on your input signal source.</p> <ul style="list-style-type: none"> <p>• Auto: Scales an image proportionally to fit the projector's native resolution in its horizontal or vertical width.</p>  <p>• Real: Projects an image as its original resolution and resizes it to fit within the display area. For input signals with lower resolutions, the projected image will be displayed in its original size.</p>   <p>• 4:3: Scales an image so that it is displayed in the center of the screen with a 4:3 aspect ratio.</p>  <p>• 16:9: Scales an image so that it is displayed in the center of the screen with a 16:9 aspect ratio.</p>  <p>• 16:10: Scales an image so that it is displayed in the center of the screen with a 16:10 aspect ratio.</p> 

<p>Picture Mode</p>	<p>The projector is preset with several predefined picture modes so that you can choose one to suit your operating environment and input signal picture type.</p> <ul style="list-style-type: none"> • Bright: Maximizes the brightness of the projected image. This mode is suitable for environments where extra-high brightness is required, such as using the projector in well lit rooms. • Presentation: Is designed for presentations. The brightness is emphasized in this mode to match PC and notebook coloring. • Spreadsheet: Is appropriate for Spreadsheet projection. • Video Conference: Is appropriate for video conference projection. • Infographic: Is perfect for presentations with the mixture of text and graphics due to its high color brightness and better color gradation to see the details clearly. • Cinema Mode: Is appropriate for playing colorful movies, video clips from digital cameras or DVs through the PC input for best viewing in a blackened (little light) environment. • 3D: Is appropriate for playing 3D images and 3D video clips. • User 1/User 2: Recalls the settings customized based on the current available picture modes. See Reference Mode on page 45.
<p>Volume</p>	<p>Adjusts the sound level.</p>
<p>Light Mode</p>	<p>See Setting the Light Mode on page 56.</p>
<p>Information</p>	<ul style="list-style-type: none"> • Native Resolution: Shows the native resolution of the projector. • Detected Resolution: Shows the native resolution of the input signal. • Source: Shows the current signal source. • Picture Mode: Shows the selected mode in the Picture menu. • Light Mode: Shows the selected mode in the Light Settings menu. • 3D Format: Shows the current 3D mode. • Color System: Shows input system format. • Light Usage Time: Shows the number of hours the light source has been used. • Firmware Version: Shows the firmware version of your projector. • Service Code: Show the projector's serial number.
<p>Menu Type</p>	<p>Switches to the Advanced OSD menu. See Using the projector menus under non-Launcher source on page 40.</p>

Advanced menu

Picture

<p>Picture Mode</p>	<p>The projector is preset with several predefined picture modes so that you can choose one to suit your operating environment and input signal picture type.</p> <ul style="list-style-type: none"> • Bright: Maximizes the brightness of the projected image. This mode is suitable for environments where extra-high brightness is required, such as using the projector in well lit rooms. • Presentation: Is designed for presentations. The brightness is emphasized in this mode to match PC and notebook coloring. • Spreadsheet: Is appropriate for Spreadsheet projection. • Video Conference: Is appropriate for video conference projection. • Infographic: Is perfect for presentations with the mixture of text and graphics due to its high color brightness and better color gradation to see the details clearly. • Cinema Mode: Is appropriate for playing colorful movies, video clips from digital cameras or DVs through the PC input for best viewing in a blackened (little light) environment. • 3D: Is appropriate for playing 3D images and 3D video clips. • User 1/User 2: Recalls the settings customized based on the current available picture modes. See Reference Mode on page 45.
<p>Reference Mode</p>	<p>There are 2 user-definable modes if the current available picture modes are not suitable for your need. You can use one of the picture modes (except the User 1/User 2) as a starting point and customize the settings.</p> <ol style="list-style-type: none"> 1. Go to Picture > Picture Mode. 2. Press ◀/▶ to select User 1 or User 2. 3. Press ▼ to highlight Reference Mode, and press ◀/▶ to select a picture mode that is closest to your need. 4. Press ▼ to select a menu item to be changed and adjust the value. The adjustments define the selected user mode.
<p>Brightness</p>	<p>The higher the value, the brighter the image. Adjust this control so the black areas of the image appear just as black and that detail in the dark areas is visible.</p>
<p>Contrast</p>	<p>The higher the value, the greater the contrast. Use this to set the peak white level after you have previously adjusted the Brightness setting to suit your selected input and viewing environment.</p>
<p>Sharpness</p>	<p>The higher the value, the sharper the picture becomes.</p>
<p>Brilliant Color</p>	<p>This feature utilizes a new color-processing algorithm and system level enhancements to enable higher brightness while providing truer, more vibrant colors in picture. It enables a greater than 50% brightness increase in mid-tone images, which are common in video and natural scenes, so the projector reproduces images in realistic and true colors. If you prefer images with that quality, select On.</p> <p>When Off is selected, the Color Temperature function is not available.</p>

Advanced Color Settings

Gamma Selection

Gamma refers to the relationship between input source and picture brightness. Choose a preferred gamma mode from among 1.8/2.0/2.1/2.2/2.3/2.4/2.5/2.6/BenQ.

Color Temperature

There are several preset color temperature settings available to choose from: **Normal, Warm, Native, Cool**. The available settings may vary according to the signal type selected. You can also set a preferred color temperature by adjusting the following options.

Color Temperature Tuning

- **R Gain/G Gain/B Gain:** Adjusts the contrast levels of Red, Green, and Blue.
- **R Offset/G Offset/B Offset:** Adjusts the brightness levels of Red, Green, and Blue.

Color Management

This function provides six sets (RGBCMY) of colors to be adjusted. When you select each color, you can independently adjust its range and saturation according to your preference. Selects a color from among **R** (Red), **G** (Green), **B** (Blue), **C** (Cyan), **M** (Magenta), or **Y** (Yellow).

- **Hue:** Increase in the range will include colors consisted of more proportions of its two adjacent colors. Please refer to the illustration for how the colors relate to each other. For example, if you select Red and set its range at 0, only pure red in the projected picture will be selected. Increasing its range will include red close to yellow and red close to magenta.

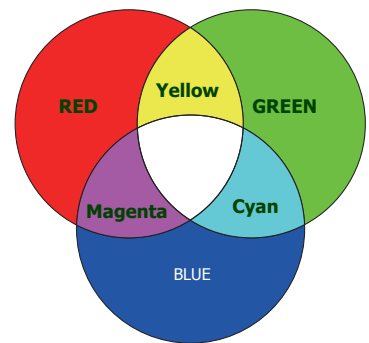

- **Saturation:** Adjusts the values to your preference. Every adjustment made will reflect to the image immediately. For example, if you select Red and set its value at 0, only the saturation of pure red will be affected.



Saturation is the amount of that color in a video picture. Lower settings produce less saturated colors; a setting of “0” removes that color from the image entirely. If the saturation is too high, that color will be overpowering and unrealistic.

- **Gain:** Adjusts the values to your preference. The contrast level of the primary color you select will be affected. Every adjustment made will reflect to the image immediately.

Light Source Mode

See [Setting the Light Mode on page 56](#).



Wall Color

Corrects the projected picture’s color when the projection surface such as a painted wall which may not be white, the Wall Color feature can help correct the projected picture’s colors to prevent possible color difference between the source and projected pictures. There are several precalibrated colors to choose from:

Light Yellow, Pink, Light Green, Blue, and Blackboard.

Reset Picture	Returns all of the adjustments you've made for the Picture menu to the factory preset values.
----------------------	--

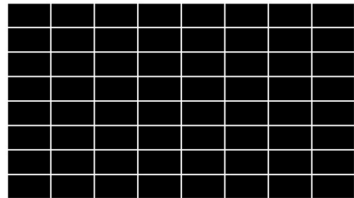
Display

Aspect Ratio	<p>There are several options to set the image's aspect ratio depending on your input signal source.</p> <ul style="list-style-type: none"> • Auto: Scales an image proportionally to fit the projector's native resolution in its horizontal or vertical width. • Real: Projects an image as its original resolution and resizes it to fit within the display area. For input signals with lower resolutions, the projected image will be displayed in its original size. • 4:3: Scales an image so that it is displayed in the center of the screen with a 4:3 aspect ratio. • 16:9: Scales an image so that it is displayed in the center of the screen with a 16:9 aspect ratio. • 16:10: Scales an image so that it is displayed in the center of the screen with a 16:10 aspect ratio.
Keystone	See Correcting keystone on page 17 .
Auto Vertical Keystone	Automatically corrects the keystone on the vertical side of the projected image.
Test Pattern	<p>Adjusts the image size and focus and check that the projected image is free from distortion.</p> 
PC & Component YPbPr Tuning	<ul style="list-style-type: none"> • Phase: Adjusts the clock phase to reduce image distortion. This function is only available when a PC signal (analog RGB) or YPbPr signal is selected. • H. Size: Adjusts the horizontal width of the image. This function is only available when a PC signal (analog RGB) is selected. 
Position	Displays the position adjustment page. To move the projected image, use the directional arrow keys. This function is only available when a PC signal (analog RGB) is selected.





<p>3D</p>	<p>This projector features a 3D function which enables you to enjoy the 3D movies, videos, and sporting events in a more realistic way by presenting the depth of the images. You need to wear a pair of 3D glasses to view the 3D images.</p> <ul style="list-style-type: none"> • 3D Mode: The default setting is Off. If you want the projector to automatically choose an appropriate 3D format when detecting 3D contents, select Auto. If the projector cannot recognize the 3D format, press ▲/▼ to choose a 3D mode from among Top Bottom, Frame Sequential, Frame Packing and Side by Side. <p> When 3D function is activated:</p> <ul style="list-style-type: none"> • The brightness level of the projected image will decrease. • The following settings cannot be adjusted: Picture Mode, Reference Mode. • The Keystone can only be adjusted within limited degrees. • 3D Sync Invert: When you discover the inversion of the image depth, enable this function to correct the problem. • Apply 3D Settings: After the 3D settings are saved, you can decide if you would like to apply them by choosing a set of 3D settings that you have saved. Once applied, the projector will automatically play the incoming 3D contents if it matches the 3D settings saved. <p> Only the set(s) of 3D settings with memorized data is available.</p> <ul style="list-style-type: none"> • Save 3D Settings: When you have successfully displayed the 3D contents after making the appropriate adjustments, you can enable this function and choose a set of 3D settings to memorize current 3D settings.
<p>HDMI Format</p>	<p>Selects a suitable color format to optimize display quality.</p> <ul style="list-style-type: none"> • Auto: Automatically selects a suitable color space and gray level for the incoming HDMI signal. • RGB Limited: Utilizes the Limited range RGB 1-254. • RGB Full: Utilizes the Full range RGB 0-255. • YUV Limited: Utilizes the Limited range RGB 1-254. • YUV Full: Utilizes the Full range RGB 0-255.



Image Resizing	<p>Digital Zoom</p> <p>Magnifies or reduces the projected image size.</p> <ol style="list-style-type: none"> 1. After the adjustment bar displays, press ▲/▼ repeatedly to reduce or magnify the image to a desired size. 2. Press OK to enter panning mode. 3. Press the directional arrows (▲, ▼, ◀, ▶) on the projector or remote control to navigate the picture.  <p>The picture can only be navigated after it is magnified. You can further magnify the picture while searching for details.</p>
	<p>Digital Shrink & Shift</p> <p>Shrinks and/or shifts the projected image.</p> <ol style="list-style-type: none"> 1. After the adjustment bar displays, press ◀/▶ repeatedly to shrink or magnify the picture to a desired size. 2. Press OK to activate digital shift function. 3. After digital shift function is activated, press the directional arrows (▲, ▼, ◀, ▶) to shift the image. 4. Press AUTO to restore the picture to its original size.  <p>The picture can only be shifted after it shrank.</p>
Reset Display	Returns all of the adjustments you've made for the Display menu to the factory preset values.

Network

Wired LAN	See Controlling the projector via LAN on page 53 .
AMX Device Discovery	When AMX Device Discovery is On, the projector can be detected by AMX controller.
MAC Address (Wired)	Displays the Mac Address for this projector.

Settings



Projector Installation	See Choosing a location on page 13 .
Remote Receiver	Allows you to enable all the remote receivers or one specific remote receiver on the projector.
Auto Source Search	Allows the projector to automatically search for a signal.
Auto Sync	<ul style="list-style-type: none"> • On: Allows the projector to automatically determines the best picture timings for the displayed image when PC signal (analog RGB) is selected and AUTO is pressed. • Off: The projector will not respond when AUTO is pressed.

<p>Light Settings</p>	<ul style="list-style-type: none"> • Reset Light Timer: See .Connect the power and restart the projector.Resetting the light timer on page 60 for details. • Light Usage Time: Displays the number of hours the light has been used.
<p>Operation Settings</p>	<p>Blank Timer</p> <p>Sets the image blank time when there is no action taken on the blank screen, once elapsed the image will return to the screen. If the preset time spans are not suitable for your need, select Disable. No matter Blank Timer is activated or not, you can press most of the keys on the projector or remote control to restore the picture.</p>
	<p>Reminder Message</p> <p>Sets the reminder messages on or off.</p>
	<p>Auto Blank</p> <p>Enables or disables the auto blank function.</p>
	<p>High Altitude Mode</p> <p>We recommend you use the High Altitude Mode when your environment is between 1500 m –3000 m above sea level, and ambient temperature is between 0°C–30°C.</p> <p>Operation under "High Altitude Mode" may cause a higher decibel operating noise level because of increased fan speed necessary to improve overall system cooling and performance.</p> <p>If you use this projector under other extreme conditions excluding the above, it may display auto shut-down symptoms, which is designed to protect your projector from over-heating. In cases like this, you should switch to High Altitude Mode to solve these symptoms. However, this is not to state that this projector can operate under any and all harsh or extreme conditions.</p>  <p>Do not use the High Altitude Mode if your altitude is between 0 m and 1500 m and ambient temperature is between 0°C and 35°C. The projector will be over cooled, if you turn the mode on under such a condition.</p>
	<p>Power On/Off Settings</p> <ul style="list-style-type: none"> • Direct Power On: Allows the projector to turn on automatically once the power is fed through the power cord. • Signal Power On: Sets whether to turn the projector directly on without pressing  POWER or  ON when the projector is in standby mode and detects a VGA signal or a HDMI signal with 5V power. • Auto Power Off: Allows the projector to turn off automatically if no input signal is detected after a set period of time to prevent unnecessary waste of light source life. <p>Power Off Timer: Sets the auto-shutdown timer.</p>

Operation Settings	<p>Instant Restart</p> <p>When Instant Restart is On, users can restart projector immediately within 90 secs after turning off projector.</p> <p>When Instant Restart is Off, users need to wait Light to cool down to restart the projector.</p>  <p>When Instant Restart is On, Quick Cooling will be grayed out.</p>
Security Settings	See Utilizing the password function on page 41 .
Baud Rate	Selects a baud rate that is identical with your computer's so that you can connect the projector using a suitable RS-232 cable and update or download the projector's firmware. This function is intended for qualified service personnel.
HDMI Equalizer	Adjusts the equalizer gain settings for an HDMI signal. The higher the setting, the stronger the gain value. If there are more than one HDMI port on the projector, select the HDMI port first before adjusting the value.
Reset Settings	Returns all of the adjustments you've made for the Settings menu to the factory preset values.

System

Language	Sets the language for the On-Screen Display (OSD) menus.
Standby Settings	<ul style="list-style-type: none"> • Standby Mode <ul style="list-style-type: none"> • Eco: The projector maintains at normal standby mode with less than 0.5W power consumption. • Normal: Allows the projector to provide audio pass through function in standby mode. • Auto Disable Network Standby Mode: Allows the projector to disable the network function after a set period of time after it enters standby mode. For instance, if 20 min is selected, the projector is able to provide the network function for 20 minutes after it enters standby mode. When 20 minutes is up, the projector enters normal standby mode. • Audio Pass Through: The projector can play sound when it is in standby mode and the corresponding jacks are correctly connected to devices. Press ◀/▶ to choose the source that you wish to use. See Connection on page 18 for how to make the connection.
Background Settings	<ul style="list-style-type: none"> • Background Settings: Sets the background color for the projector. • Splash Screen: Allows you to select which logo screen will be displayed during projector start-up.
Menu Settings	<ul style="list-style-type: none"> • Menu Type: Switches to the Basic OSD menu. • Menu Display Time: Sets the length of time the OSD will remain active after your last key press.

<p>Audio Settings</p>	<ul style="list-style-type: none"> • Sound Mode: Sets Sound Mode from among Cinema, Music, and Vocal. • Mute: Temporarily turns off the sound. • Volume: Adjusts the sound level. • Power On/Off Ring Tone: Turns on or off the ring tone when the projector is in startup and shutdown process.  <p>The only way to change Power On/Off Ring Tone is setting On or Off here. Setting the sound mute or changing the sound level will not affect the Power On/Off Ring Tone.</p>
<p>Restart intelx86 Smart System</p>	<p>Restarts intel smart system. Closes all apps, turn off the smart system and turns it on again.</p>
<p>Factory Default</p>	<p>Returns all settings to the factory preset values.</p>  <p>The following settings will still remain: Keystone, Auto Vertical Keystone, Projector Installation, Light Usage Time, Security Settings, Baud Rate, High Altitude Mode, HDMI Equalizer, Digital Shrink & Shift, BLANK, Network.</p>
<p>Reset System</p>	<p>Returns all of the adjustments you've made for the System menu to the factory preset values.</p>

Information

<p>Information</p>	<ul style="list-style-type: none"> • Native Resolution: Shows the native resolution of the projector. • Detected Resolution: Shows the native resolution of the input signal. • Source: Shows the current signal source. • Picture Mode: Shows the selected mode in the Picture menu. • Light Mode: Shows the selected mode in the Light Settings menu. • 3D Format: Shows the current 3D mode. • Color System: Shows input system format. • Light Usage Time: Shows the number of hours the light source has been used. • Firmware Version: Shows the firmware version of your projector. • Service Code: Shows the projector serial number.
---------------------------	---

Controlling the projector via LAN

Wired LAN allows you to manage the projector from a computer using a web browser when the computer and the projector are properly connected to the same local area network.

Configuring the Wired LAN Settings

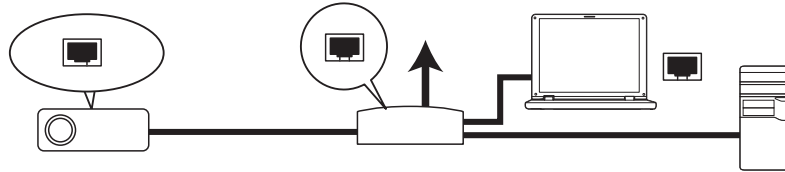

If you are in a DHCP environment:

1. Take a RJ45 cable and connect one end to the LAN input jack of the projector and the other end to the RJ45 port.



• When connecting the RJ45 cable, avoid coiling and intertwining the cable as it may cause signal noise or interruption.

2. Go to **Advanced Menu - System > Network > Wired LAN**. Press **OK**. The **Wired LAN** page appears.
3. Press **▼** to select **DHCP** and press **◀/▶** to select **On**.
4. Please wait for around 15 - 20 seconds, and then re-enter the **Wired LAN** page.
5. The **IP Address**, **Subnet Mask**, **Default Gateway**, and **DNS Server** settings will be displayed. Note down the IP address displayed in the **IP Address** row.







• If the IP Address still does not display, contact your ITS administrator.

6. Go back to **Advanced Menu - System > Network > Wired LAN** page.
7. Press **▼** to highlight **AMX Device Discovery** and press **◀/▶** to select **On** or **Off**. When **AMX Device Discovery** is **On**, the projector can be detected by AMX controller.

If you are in a non-DHCP environment:

1. Go to **Advanced Menu - System > Network > Wired LAN** page.
2. Press **▼** to select **DHCP** and press **◀/▶** to select **Off**.
3. Contact your ITS administrator for information on the **IP Address**, **Subnet Mask**, **Default Gateway**, and **DNS Server** settings.
4. Press **▼** to select the item you want to modify and press **OK**.
5. Press **◀/▶** to move the cursor and then press **▲/▼** to enter the value.
6. To save the setting, press **OK**. If you do not want to save the setting, press **BACK**.
7. Press **▼** to highlight **Apply** and press **OK**.
8. Go back to **Advanced Menu - System > Network > Wired LAN** page., press **▼** to highlight **AMX Device Discovery** and press **◀/▶** to select **On** or **Off**.
9. Press **MENU** to exit the menu.

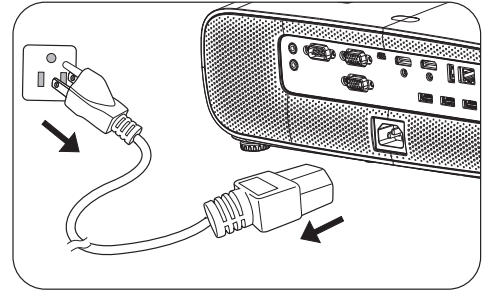

Shutting down the projector

1. Press  on the projector or  on the remote control and a confirmation message will appear prompting you. If you don't respond in a few seconds, the message will disappear.
2. Press  or  a second time. The power indicator flashes orange, the projection lamp shuts down, and the fans will continue to run for approximately 90 seconds to cool down the projector.
3. Under windows interface, press windows start key and click power off. (Windows > Power > Power Off)
4. Once the cooling process finishes, the power indicator becomes a steady orange and fans stop. Disconnect the power cord from the power outlet.



- To protect the lamp, the projector will not respond to any commands during the cooling process.
- Avoid turning on the projector immediately after turning it off as excessive heat may shorten lamp life.
- Lamp life results will vary depending on environmental conditions and usage.

Direct power off

The AC power cord can be pulled out right after the projector is turned off. To protect the lamp, wait about 10 minutes before re-starting the projector. If you attempt to re-start the projector, the fans may run for a few minutes to cool down. In such cases, press  or  again to start the projector after the fans stop and the power indicator turns orange.

Maintenance

Care of the projector

Cleaning the lens

Clean the lens whenever you notice dirt or dust on the surface. Please be sure to turn off the projector and let it cool down completely before cleaning the lens.

- Use a canister of compressed air to remove dust.
- If there is dirt or smears, use lens-cleaning paper or moisten a soft cloth with lens cleaner and gently wipe the lens surface.
- Never use any type of abrasive pad, alkaline/acid cleaner, scouring powder, or volatile solvent, such as alcohol, benzene, thinner or insecticide. Using such materials or maintaining prolonged contact with rubber or vinyl materials may result in damage to the projector surface and cabinet material.

Cleaning the projector case

Before you clean the case, turn the projector off using the proper shutdown procedure as described in [Menu operation on page 43](#) and unplug the power cord.

- To remove dirt or dust, wipe the case with a soft, lint-free cloth.
- To remove stubborn dirt or stains, moisten a soft cloth with water and a neutral pH detergent. Then wipe the case.



Never use wax, alcohol, benzene, thinner or other chemical detergents. These can damage the case.

Storing the projector

If you need to store the projector for an extended time, please follow the instructions below:

- Make sure the temperature and humidity of the storage area are within the recommended range for the projector. Please refer to [Specifications on page 63](#) or consult your dealer about the range.
- Retract the adjuster feet.
- Remove the battery from the remote control.
- Pack the projector in its original packing or equivalent.

Transporting the projector

It is recommended that you ship the projector with its original packing or equivalent.

Lamp information

Getting to know the lamp hour

When the projector is in operation, the duration (in hours) of lamp usage is automatically calculated by the built-in timer. The method of calculating the equivalent lamp hour is as follows:

- I. **Light Usage Time** = $(x+y+z+a)$ hours, if
 - Time used in **Normal** mode = x hours
 - Time used in **ECO** mode = y hours
 - Time used in **SmartEco** mode = z hours
 - Time used in **LampSave** mode = a hours

2. Equivalent light source hour = α hours

$\alpha = x(A'/X) + y(A'/Y) + z(A'/Z) + a(A'/A)$, if

X = lamp life spec of **Normal** mode

Y = lamp life spec of **ECO** mode

Z = lamp life spec of **SmartEco** mode

A = lamp life spec of **LampSave** mode

A' is the longest lamp life spec among X, Y, Z, A



When you calculate Equivalent Lamp hour manually, it will probably have deviation from the value shown in OSD menu since projector system calculates Time used for each lamp mode in "Minutes" then rounds down to an integer in hours shown in OSD.



For Time used in each lamp mode shown in OSD menu:

- Time used is accumulated and rounded down to an integer in Hours.

- When time used is less than 1 hour, it shows 0 hours.

When you calculate Equivalent Lamp hour manually, it will probably have deviation from the value shown in OSD menu since projector system calculates Time used for each lamp mode in "Minutes" then rounds down to an integer in hours shown in OSD.

To obtain the lamp hour information:

1. Go to **Advanced Menu - Settings > Light Settings** and press **OK**. The **Light Settings** page appears.
2. Press **▼** to select **Light Usage Time** and press **OK**. The **Light Usage Time** information is displayed.

You can also get the lamp hour information on the **INFORMATION** menu.

Extending lamp life

- Setting the **Light Mode**

Go to **Advanced Menu - Picture > Light Source Mode** and select a suitable lamp power from among the provided modes.

Setting the projector in **ECO** or **SmartEco** mode extends lamp life.

Lamp mode	Description
Normal	Provides full lamp brightness
ECO	Lowers brightness to extend the lamp life and decreases the fan noise
SmartEco	Adjusts the lamp power automatically depending on the content brightness level while optimizing display quality
LampSave	Adjusts the lamp power automatically depending on the content brightness level while offering a longer lamp life

- Setting **Auto Off**

This function allows the projector to turn off automatically if no input signal is detected after a set period of time to prevent unnecessary waste of lamp life.

To set **Auto Off**, go to **Advanced Menu - Settings > Operation Settings > Auto Power Off** and press **◀/▶**.

Timing of replacing the lamp

When the **Lamp indicator** lights up or a message appears suggesting it is time to replace the lamp, please consult your dealer or go to <http://www.BenQ.com> before installing a new lamp. An old lamp may cause a malfunction in the projector and in some instances the lamp may explode.



- The apparent brightness of the projected image will vary depending on the ambient lighting conditions, selected input signal contrast/brightness settings, and is directly proportional to projection distance.
- The lamp brightness will decline over time and may vary within the lamp manufacturers specifications. This is normal and expected behavior.
- The **LIGHT indicator light** and **TEMPerature warning light** will light up if the lamp becomes too hot. Turn the power off and let the projector cool for 45 minutes. If the Lamp or Temp indicator still lights up after turning the power back on, please contact your dealer. See [Indicators on page 61](#).

The following Lamp warning displays will remind you to change the lamp.

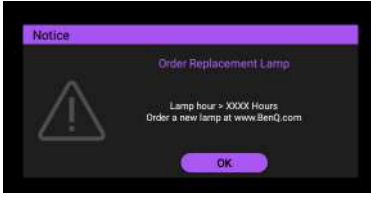
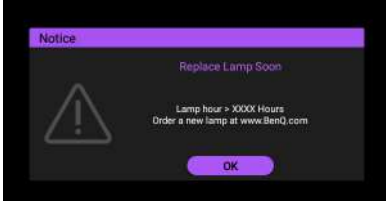
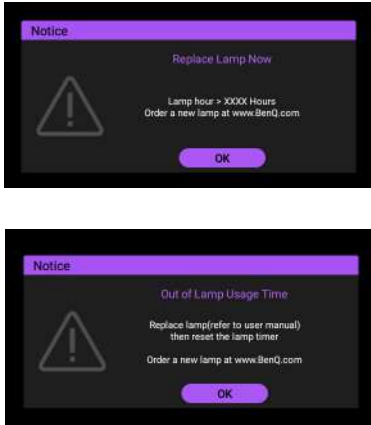
	<p>Install a new lamp for optimal performance. Press OK to dismiss the message.</p>
	<p>It is strongly recommended that you replace the lamp at this age. The lamp is a consumable item. The lamp brightness diminishes with use. This is normal lamp behavior. You can replace the lamp whenever you notice that the brightness level has significantly diminished. Press OK to dismiss the message.</p>
	<p>The lamp MUST be replaced before the projector will operate normally. Press OK to dismiss the message.</p>



"XXXX" shown in the above messages are numbers that vary depending on different models.

Replacing the lamp (FOR SERVICE PERSONNEL ONLY)

Please consult your dealer or go to <http://www.BenQ.com> before installing a new lamp. An old lamp may cause a malfunction in the projector and in some instances the light may explode. Please seek support from a qualified service technician to replace the lamp of your projector. Please unplug the power cable of the BenQ projector and wait for 10 minutes to ensure power-off progress completely to avoid electric shock. Please also refer to the product user manual for safety instructions to ensure a safe lamp replacement.



- To reduce the risk of electrical shock, always turn the projector off and disconnect the power cord before changing the lamp.



- This illustration on the top of the lamp module indicates the lamp module is high temperature and may burn your fingers. We suggest to seek support from a qualified service technician to replace the lamp. And allow the projector to cool for at least 45 minutes before replacing the lamp.

- To reduce the risk of injuries to fingers and damage to internal components, use caution when removing lamp glass that has shattered into sharp pieces.
 - To reduce the risk of injuries to fingers and/or compromising image quality by touching the lens, do not touch the empty lamp compartment when the lamp is removed.
 - This lamp contains mercury. Consult your local hazardous waste regulations to dispose of this lamp in a proper manner.
 - To assure optimal performance from the projector, it is recommended that you purchase a qualified projector lamp for lamp replacement.
 - If lamp replacement is performed while the projector is suspended upside-down, make sure that no one is underneath the lamp socket to avoid any possible injury or damage to the human eyes caused by fractured lamp.
 - Ensure good ventilation when handling broken lamps. We recommend that you use respirators, safety glasses, goggles or face shield and wear protective clothing such as gloves.
1. Turn the power off and disconnect the projector from the power outlet. If the lamp is hot, avoid burns by waiting for approximately 45 minutes until the lamp has cooled.
 2. Loosen the screw(s) that secure the lamp cover on the side of the projector until the lamp cover loosens.

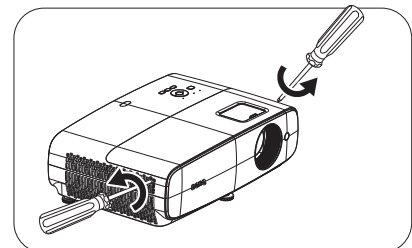

3. Remove the lamp cover from the projector.



- Do not turn the power on with the lamp cover open.
- Do not insert your fingers between the lamp and the projector. The sharp edges inside the projector may cause injuries

4. Remove the safety mylar.
5. Disconnect the lamp connector.

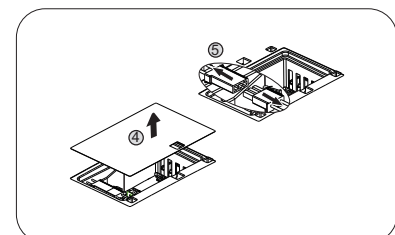
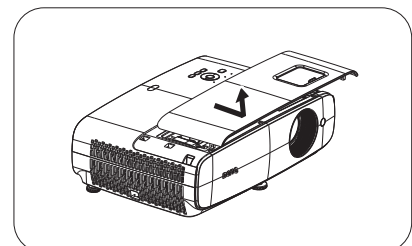

6. Loosen the screw(s) that secure the inner lamp.
7. Lift the handle so that it stands up.

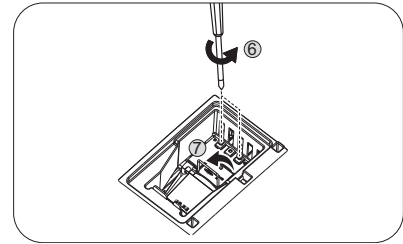

8. Use the handle to slowly pull the lamp out of the projector.



- Pulling it too quickly may cause the lamp to break and scatter broken glass in the projector.
- Do not place the lamp in locations where water might splash on it, children can reach it, or near flammable materials.
- Do not insert your hands into the projector after the lamp is removed. The sharp edges inside the projector may cause injuries. If you touch the optical components inside, it could cause color unevenness and distortion of the projected images.

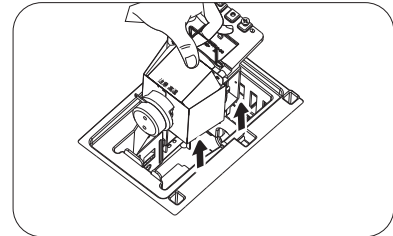

9. Insert the lamp connector.

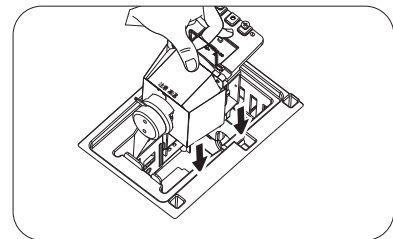

10. Tighten the screw(s) that secures the lamp.

11. Ensure the handle is fully laid flat and locked in place.



- Loose screw may cause a bad connection, which could result in malfunction.
- Do not over tighten the screw.

12. Connect the lamp connector.

13. Put the safety mylar back to the top.

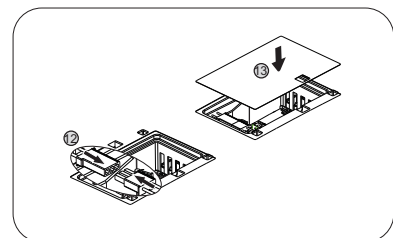
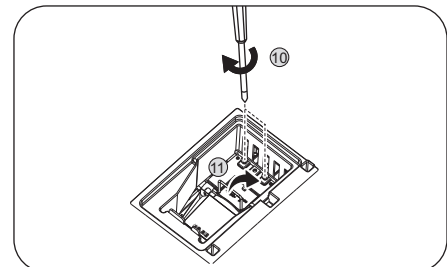

14. Replace the lamp cover on the projector.

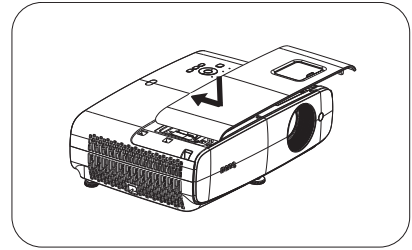

15. Tighten the screw that secures the lamp cover.



- Loose screw may cause a bad connection, which could result in malfunction.
- Do not over tighten the screw.

16. .Connect the power and restart the projector.Resetting the light timer

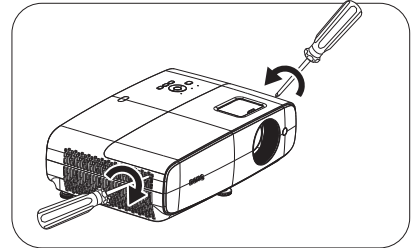



























































17. After the startup logo, open the On-Screen Display (OSD) menu. Go to **Advanced Menu- Settings > Light Settings** and press **OK**. The **Light Settings** page appears. Highlight **Reset Light Timer** and press **OK**. A warning message is displayed asking if you want to reset the light timer. Highlight **Reset** and press **OK**. The light time will be reset to “0”.



- Do not reset if the lamp is not new or replaced as this could cause damage.

Indicators

LIGHT			Status & Description
POWER ○	TEMP ○	LAMP ○	
System events			
			System is in stand-by mode
			System is powering up
			System is under normal operation
			System is cooling down
			Downloading
			Colorwheel start fail
			Scaler reset fail
			Light source life exhausted
Burn-In events			
			Burn-in on (Lamp on)
			Burn-in off (Lamp off)
Lamp events			
			Lamp error in normal operation
			Lamp is not lit up
Thermal events			
			Fan 1 error (the actual fan speed is outside the desired speed)
			Fan 2 error (the actual fan speed is outside the desired speed)
			Fan 3 error (the actual fan speed is outside the desired speed)
			Fan 4 error (the actual fan speed is outside the desired speed)
			Temperature I error (over limited temperature)

	 : Off	 : Orange On  : Orange Flashing	 : Green On  : Green Flashing	 : Red On  : Red Flashing
---	---	--	--	--

Troubleshooting

? The projector does not turn on.

Cause	Remedy
There is no power from the power cord.	Plug the power cord into the AC power jack on the projector, and plug the power cord into the power outlet. If the power outlet has a switch, make sure that it is switched on.
Attempting to turn the projector on again during the cooling process.	Wait until the cooling down process has completed.

? No picture

Cause	Remedy
The video source is not turned on or connected correctly.	Turn the video source on and check that the signal cable is connected correctly.
The projector is not correctly connected to the input signal device.	Check the connection.
The input signal has not been correctly selected.	Select the correct input signal with the SOURCE key.

? Blurred image

Cause	Remedy
The projection lens is not correctly focused.	Adjust the focus of the lens using the focus ring.
The projector and the screen are not aligned properly.	Adjust the projection angle and direction as well as the height of the projector if necessary.

? Remote control does not work.

Cause	Remedy
The batteries are out of power.	Replace both of the batteries with new ones.
There is an obstacle between the remote control and the projector.	Remove the obstacle.
You are too far away from the projector.	Stand within 8 meters (26 feet) of the projector.

? The password is incorrect.

Cause	Remedy
You do not remember the password.	See Entering the password recall procedure on page 42.

Specifications

Projector specifications



All specifications are subject to change without notice.

Optical

Resolution

1920 x 1080 1080p

Display system

1-CHIP DMD

Lens

F = 1.84 ~ 2, f = 12 ~ 15.6 mm

Clear focus range

1.2m ~ 5.1m @ Wide,
1.3m ~ 4.9m @ Tele

Light source

240W±3% @ Normal Mode

Zoom ratio

1.3x ±2%

Electrical

Power supply

AC100–240V, 3.40 A, 50/60 Hz (Automatic)

Power consumption

Max.: 350 W; Standby: 0.5W Max. at 100 ~ 240VAC

Mechanical

Weight

4.2 Kg ± 200 g (9.3 lbs ± 0.44 lbs)

Output terminals

RGB output

D-Sub 15-pin (female) x 1

Speaker

5 watt x 2

Audio signal output

PC audio jack x 1

Control

USB

Type-A: 1A x 3 (USB Reader)

Type-A: 1.5A x 1 (Power supply)

Mini-B x 1, Type-A (USB Wi-Fi dongle) x 1

RS-232 serial control

9 pin x 1

IR receiver x 2

LAN control

Wired (RJ45)

Input terminals

Computer input

RGB input

D-Sub 15-pin (female) x 1

Video signal input

SD/HDTV signal input

Analog - Component

(through RGB input)

Digital - HDMI x 2

Audio signal input

PC audio jack x 1

Environmental Requirements

Operating temperature

0°C–40°C at sea level

Operating relative humidity

10%–90% (without condensation)

Operating altitude

0–1499 m at 0°C–35°C

1500–3000 m at 0°C–30°C (with

High Altitude Mode on)

Storage temperature

-20°C–60°C at sea level

Storage humidity

10%–90% RH (without condensation)

Storage altitude

30°C@ 0~12,200m above sea level

Transporting

Original packing or equivalent is recommended

Repairing

Please visit below website and choose your country to find your service contact window.

<http://www.benq.com/welcome>

Dimensions

380 mm (W) x 129 mm (H) x 264 mm (D)

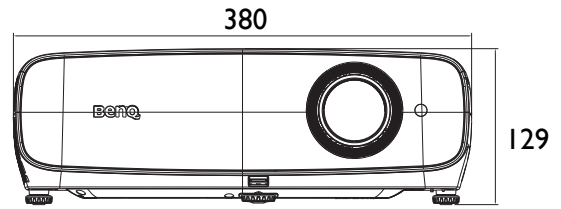
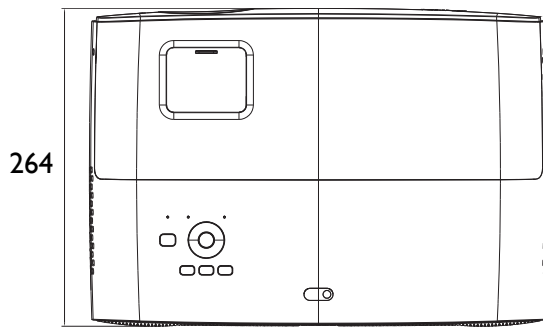

Unit: mm

Timing chart

Supported timing for PC input

Resolution	Mode	Vertical Frequency (Hz)	Horizontal Frequency (kHz)	Pixel Frequency (MHz)	Supported 3D format		
					Frame Sequential	Top Bottom	Side by Side
640 x 480	VGA_60	59.940	31.469	25.175	V	V	V
	VGA_72	72.809	37.861	31.500			
	VGA_75	75.000	37.500	31.500			
	VGA_85	85.008	43.269	36.000			
720 x 400	720 x 400_70	70.087	31.469	28.3221			
800 x 600	SVGA_60	60.317	37.879	40.000	V	V	V
	SVGA_72	72.188	48.077	50.000			
	SVGA_75	75.000	46.875	49.500			
	SVGA_85	85.061	53.674	56.250			
	SVGA_120 (Reduce Blanking)	119.854	77.425	83.000	V		
1024 x 768	XGA_60	60.004	48.363	65.000	V	V	V
	XGA_70	70.069	56.476	75.000			
	XGA_75	75.029	60.023	78.750			
	XGA_85	84.997	68.667	94.500			
	XGA_120 (Reduce Blanking)	119.989	97.551	115.5	V		
1152 x 864	1152 x 864_75	75	67.5	108			
1024 x 576	BenQ Notebook_timing	60.0	35.820	46.966			
1024 x 600	BenQ Notebook_timing	64.995	41.467	51.419			
1280 x 720	1280 x 720_60	60	45.000	74.250	V	V	V
1280 x 768	1280 x 768_60	59.87	47.776	79.5	V	V	V
1280 x 800	WXGA_60	59.810	49.702	83.500	V	V	V
	WXGA_75	74.934	62.795	106.500			
	WXGA_85	84.880	71.554	122.500			
	WXGA_120 (Reduce Blanking)	119.909	101.563	146.25	V		
1280 x 1024	SXGA_60	60.020	63.981	108.000		V	V
	SXGA_75	75.025	79.976	135.000			
	SXGA_85	85.024	91.146	157.500			
1280 x 960	1280 x 960_60	60.000	60.000	108.000		V	V
	1280 x 960_85	85.002	85.938	148.500			
1360 x 768	1360 x 768_60	60.015	47.712	85.5		V	V
1440 x 900	WXGA+_60	59.887	55.935	106.500		V	V
1400 x 1050	SXGA+_60	59.978	65.317	121.750		V	V
1600 x 1200	UXGA	60.000	75.000	162.000		V	V
1680 x 1050	1680 x 1050_60	59.954	65.290	146.250		V	V
640 x 480@67Hz	MAC13	66.667	35.000	30.240			
832 x 624@75Hz	MAC16	74.546	49.722	57.280			
1024 x 768@75Hz	MAC19	74.93	60.241	80.000			
1152 x 870@75Hz	MAC21	75.060	68.680	100.000			



V: support manually set 3D format

Supported timing for HDMI (HDCP) input

• PC timings

Resolution	Mode	Vertical Frequency (Hz)	Horizontal Frequency (kHz)	Pixel Frequency (MHz)	Supported 3D format		
					Frame Sequential	Top Bottom	Side by Side
640 x 480	VGA_60	59.940	31.469	25.175	V	V	V
	VGA_72	72.809	37.861	31.500			
	VGA_75	75.000	37.500	31.500			
	VGA_85	85.008	43.269	36.000			
720 x 400	720 x 400_70	70.087	31.469	28.3221			
800 x 600	SVGA_60	60.317	37.879	40.000	V	V	V
	SVGA_72	72.188	48.077	50.000			
	SVGA_75	75.000	46.875	49.500			
	SVGA_85	85.061	53.674	56.250			
	SVGA_120 (Reduce Blanking)	119.854	77.425	83.000	V		
1024 x 768	XGA_60	60.004	48.363	65.000	V	V	V
	XGA_70	70.069	56.476	75.000			
	XGA_75	75.029	60.023	78.750			
	XGA_85	84.997	68.667	94.500			
	XGA_120 (Reduce Blanking)	119.989	97.551	115.5	V		
1152 x 864	1152 x 864_75	75	67.5	108			
1024 x 576@60Hz	BenQ Notebook Timing	60.00	35.820	46.996			
1024 x 600@65Hz	BenQ Notebook Timing	64.995	41.467	51.419			
1280 x 720	1280 x 720_60	60	45.000	74.250	V	▲	▲
1280 x 768	1280 x 768_60	59.870	47.776	79.5	V	V	V
1280 x 800	WXGA_60	59.810	49.702	83.500	V	V	V
	WXGA_75	74.934	62.795	106.500			
	WXGA_85	84.880	71.554	122.500			
	WXGA_120 (Reduce Blanking)	119.909	101.563	146.25	V		
1280 x 1024	SXGA_60	60.020	63.981	108.000		V	V
	SXGA_75	75.025	79.976	135.000			
	SXGA_85	85.024	91.146	157.500			
1280 x 960	1280 x 960_60	60.000	60.000	108		V	V
	1280 x 960_85	85.002	85.938	148.500			
1360 x 768	1360 x 768_60	60.015	47.712	85.500		V	V
1440 x 900	WXGA+_60	59.887	55.935	106.500		V	V
1400 x 1050	SXGA+_60	59.978	65.317	121.750		V	V
1600 x 1200	UXGA	60.000	75.000	162.000		V	
1680 x 1050	1680 x 1050_60	59.954	65.290	146.250		V	V
640 x 480@67Hz	MAC13	66.667	35.000	30.240			
832 x 624@75Hz	MAC16	74.546	49.722	57.280			
1024 x 768@75Hz	MAC19	75.020	60.241	80.000			
1152 x 870@75Hz	MAC21	75.06	68.68	100.00			
1920 x 1080@60Hz	1920 x 1080_60 (CEA-861)	60	67.5	148.5	V	▲	▲
1920 x 1200	1920 x 1200_60 (Reduce Blanking)	59.95	74.038	154	V	V	V
1920x1080@120HZ	1920X1080_120	120.000	135.000	297	V		
1920x1200@120HZ	1920X1200_120 (Reduce Blanking)	119.909	152.404	317.00	V		



• ▲: support auto-detect 3D and manually set 3D format. If source can output CEA861 720p/1080p and color space is RGB with 3D infoframe then 3D auto detect function is also workable.

• V: support manually set 3D format

• Video timings

Timing	Resolution	Vertical Frequency (Hz)	Horizontal Frequency (kHz)	Pixel Frequency (MHz)	Supported 3D format			
					Frame Sequential	Frame Packing	Top Bottom	Side by Side
480i	720(1440) x 480	59.94	15.73	27	V			
480p	720 x 480	59.94	31.47	27	V			
576i	720 x 576	50	15.63	27				
576p	720 x 576	50	31.25	27				
720/50p	1280 x 720	50	37.5	74.25		▲	▲	▲
720/60p	1280 x 720	60	45.00	74.25	V	▲	▲	▲
1080/24P	1920 x 1080	24	27	74.25		▲	▲	▲
1080/25P	1920 x 1080	25	28.13	74.25				
1080/30P	1920 x 1080	30	33.75	74.25				
1080/50i	1920 x 1080	50	28.13	74.25				▲
1080/60i	1920 x 1080	60	33.75	74.25				▲
1080/50P	1920 x 1080	50	56.25	148.5			▲	▲
1080/60P	1920 x 1080	60	67.5	148.5	V		▲	▲
1080/120p	1920 x 1080	120	135	297	V			



• ▲: support auto-detect 3D and manually set 3D format. If source can output CEA861 720p/1080p and color space is RGB with 3D inframe then 3D auto detect function is also workable.

• V: support manually set 3D format

Supported timing for Component-YPbPr input

Timing	Resolution	Vertical Frequency (Hz)	Horizontal Frequency (kHz)	Pixel Frequency (MHz)	Supported 3D format
					Frame Sequential
480i	720 x 480	59.94	15.73	13.5	V
480p	720 x 480	59.94	31.47	27	V
576i	720 x 576	50	15.63	13.5	
576p	720 x 576	50	31.25	27	
720/50p	1280 x 720	50	37.5	74.25	
720/60p	1280 x 720	60	45.00	74.25	V
1080/50i	1920 x 1080	50	28.13	74.25	
1080/60i	1920 x 1080	60	33.75	74.25	
1080/24P	1920 x 1080	24	27	74.25	
1080/25P	1920 x 1080	25	28.13	74.25	
1080/30P	1920 x 1080	30	33.75	74.25	
1080/50P	1920 x 1080	50	56.25	148.5	
1080/60P	1920 x 1080	60	67.5	148.5	



V: support manually set 3D format