

**NEC**

**Portable Projector**

***LT265/LT245***

---

***User's Manual***



# Important Information

## Safety Cautions

### Precautions

Please read this manual carefully before using your NEC LT265/LT245 Projector and keep the manual handy for future reference. Your serial number is located on the bottom of your projector. Record it here:

#### CAUTION



To turn off main power, be sure to remove the plug from power outlet.  
The power outlet socket should be installed as near to the equipment as possible, and should be easily accessible.

#### CAUTION



TO PREVENT SHOCK, DO NOT OPEN THE CABINET.  
NO USER-SERVICEABLE PARTS INSIDE.  
REFER SERVICING TO QUALIFIED NEC SERVICE PERSONNEL.



This symbol warns the user that uninsulated voltage within the unit may be sufficient to cause electrical shock. Therefore, it is dangerous to make any kind of contact with any part inside of the unit.



This symbol alerts the user that important information concerning the operation and maintenance of this unit has been provided.  
The information should be read carefully to avoid problems.

**WARNING:** TO PREVENT FIRE OR SHOCK, DO NOT EXPOSE THIS UNIT TO RAIN OR MOISTURE.  
DO NOT USE THIS UNIT'S PLUG WITH AN EXTENSION CORD OR IN AN OUTLET UNLESS ALL THE PRONGS CAN BE FULLY INSERTED.  
DO NOT OPEN THE CABINET. THERE ARE HIGH-VOLTAGE COMPONENTS INSIDE. ALL SERVICING MUST BE DONE BY QUALIFIED NEC SERVICE PERSONNEL.

### DOC Compliance Notice (for Canada only)

This Class B digital apparatus meets all requirements of the Canadian Interference-Causing Equipment Regulations.

### Acoustic Noise Information Ordinance-3. GSGV (for Germany only):

The sound pressure level is less than 70 dB (A) according to ISO 3744 or ISO 7779.



#### CAUTION

Do not look into the laser pointer while it is on and do not point the laser beam at a person. Serious injury could result.

This label is underneath the remote control.

### WARNING TO CALIFORNIA RESIDENTS:

Handling the cables supplied with this product, will expose you to lead, a chemical known to the State of California to cause birth defects or other reproductive harm. Wash hands after handling.

### RF Interference (for USA only)

#### WARNING

The Federal Communications Commission does not allow any modifications or changes to the unit EXCEPT those specified by NEC Solutions (America), Inc. in this manual. Failure to comply with this government regulation could void your right to operate this equipment. This equipment has been tested and found to comply with the limits for a Class B digital device, pursuant to Part 15 of the FCC Rules. These limits are designed to provide reasonable protection against harmful interference in a residential installation. This equipment generates, uses, and can radiate radio frequency energy and, if not installed and used in accordance with the instructions, may cause harmful interference to radio communications. However, there is no guarantee that interference will not occur in a particular installation.

If this equipment does cause harmful interference to radio or television reception, which can be determined by turning the equipment off and on, the user is encouraged to try to correct the interference by one or more of the following measures:

- Reorient or relocate the receiving antenna.
- Increase the separation between the equipment and receiver.
- Connect the equipment into an outlet on a circuit different from that to which the receiver is connected.
- Consult the dealer or an experienced radio / TV technician for help.

For UK only: In UK, a BS approved power cable with moulded plug has a Black (five Amps) fuse installed for use with this equipment. If a power cable is not supplied with this equipment please contact your supplier.

### Important Safeguards

These safety instructions are to ensure the long life of your projector and to prevent fire and shock. Please read them carefully and heed all warnings.

### Installation

1. For best results, use your projector in a darkened room.
2. Place the projector on a flat, level surface in a dry area away from dust and moisture.
3. Do not place your projector in direct sunlight, near heaters or heat radiating appliances. Exposure to direct sunlight, smoke or steam can harm internal components.
4. To avoid premature lamp failure, do not tilt the front of the projector up or down by more than 7° from level.
5. Handle your projector carefully. Dropping or jarring can damage internal components.
6. Do not place heavy objects on top of the projector.
7. If you wish to have the projector installed on the ceiling:
  - a. Do not attempt to install the projector yourself.
  - b. The projector must be installed by qualified technicians in order to ensure proper operation and reduce the risk of bodily injury.
  - c. In addition, the ceiling must be strong enough to support the projector and the installation must be in accordance with any local building codes.
  - d. Please consult your dealer for more information.

### Fire and Shock Precautions

1. Ensure that there is sufficient ventilation and that vents are unobstructed to prevent the build-up of heat inside your projector. Allow at least 4 inches (10 cm) of space between your projector and a wall.
2. Prevent foreign objects such as paper clips and bits of paper from falling into your projector.  
Do not attempt to retrieve any objects that might fall into your projector. Do not insert any metal objects such as a wire or screwdriver into your projector. If something should fall into your projector, disconnect it immediately and have the object removed by a qualified NEC service personnel.
3. Do not place any liquids on top of your projector.
4. Do not look into the lens while the projector is on. Serious damage to your eyes could result.
5. Keep any items such as magnifying glass out of the light path of the projector. The light being projected from the lens is extensive, therefore any kind of abnormal objects that can redirect light coming out of the lens, can cause unpredictable outcome such as fire or injury to the eyes.
6. Do not cover the lens with the supplied lens cap or equivalent while the projector is on. Doing so can lead to melting of the cap and possibly burning your hands due to the heat emitted from the light output.
7. The projector is designed to operate on a power supply of 100-240V AC 50/60 Hz. Ensure that your power supply fits this requirement before attempting to use your projector.
8. Handle the power cable carefully and avoid excessive bending.  
A damaged cord can cause electric shock or fire.
9. If the projector is not to be used for an extended period of time, disconnect the plug from the power outlet.
10. Do not touch the power plug during a thunderstorm. Doing so can cause electrical shock or fire.
11. Do not handle the power plug with wet hands.
12. When using a LAN cable:  
For safety, do not connect to the connector for peripheral device wiring that might have excessive voltage.

#### CAUTION

- Do not try to touch the ventilation outlet on the front side as it can become heated while the projector is turned on.
- Do not use the tilt-foot for purposes other than originally intended. Misuses such as gripping the tilt-foot or hanging on the wall can cause damage to the projector.
- Before putting the projector in the soft case, be sure to retract the feet. Failure to do so may cause the damage to the projector.
- Do not send the projector in the soft case by parcel delivery service or cargo shipment. The projector inside the soft case could be damaged.
- Select [High] in Fan mode if you continue to use the projector for consecutive days. (From the menu, select [Setup] → [Options] → [Fan Mode] → [High].)
- Do not unplug the power cable from the wall outlet under any one of the following circumstances.  
Doing so can cause damage to the projector:
  - \* While the projector's lamp lights.
  - \* While the cooling fans are running. (The cooling fans continue to work for 90 seconds after the projector is turned off).
  - \* While the PC CARD Access Indicator lights. Doing so can damage your PC memory card.

### Lamp Replacement

- To replace the lamp, follow all instructions provided on page [119](#).
- Be sure to replace the lamp when the message “**The lamp has reached the end of its usable life. Please replace the lamp.**” appears. If you continue to use the lamp after the lamp has reached the end of its usable life, the lamp bulb may shatter, and pieces of glass may be scattered in the lamp case. Do not touch them as the pieces of glass may cause injury.

If this happens, contact your NEC dealer for lamp replacement.

- Allow a minimum of 90 seconds to elapse after turning off the projector. Then turn off the main power switch, disconnect the power cable and allow 60 minutes to cool the projector before replacing the lamp.

# Table of Contents

---

<b>Important Information</b> .....	i
<b>1. Introduction</b> .....	1
<b>1</b> What's in the Box? .....	2
<b>2</b> Introduction to the Projector .....	3
<b>3</b> Part Names of the Projector .....	5
Carrying the Projector .....	5
Top Features .....	7
Terminal Panel Features .....	8
<b>4</b> Part Names of the Remote Control .....	10
<b>2. Installation and Connections</b> .....	13
<b>1</b> Setting Up the Screen and the Projector .....	14
Selecting a Location .....	14
Throw Distance and Screen Size .....	15
<b>2</b> Making Connections .....	17
Enabling the computer's external display .....	17
Connecting Your PC or Macintosh Computer .....	17
To connect SCART output (RGB) .....	18
Connecting an External Monitor .....	19
Connecting Your DVD Player with Component Output .....	20
Connecting Your VCR or Laser Disc Player .....	21
Connecting to a Network .....	22
Inserting and Removing a PC Card .....	24
Connecting the Supplied Power Cable .....	26
<b>3. Projecting an Image (Basic Operation)</b> .....	27
<b>1</b> Turning on the Projector .....	28
<b>2</b> Selecting a Source .....	30
<b>3</b> Adjusting the Picture Size and Position .....	31
<b>4</b> Correcting Keystone Distortion .....	33
<b>5</b> Optimizing an RGB Image Automatically .....	35
<b>6</b> Turning Up or Down Volume .....	35
<b>7</b> Using the Laser Pointer .....	36
<b>8</b> Turning off the Projector .....	37
<b>9</b> After Use .....	37
<b>4. Convenient Features</b> .....	38
<b>1</b> Turning Off the Image and Sound .....	39
<b>2</b> Freezing a Picture .....	39
<b>3</b> Using the Pointer .....	39
<b>4</b> Enlarging and Moving a Picture .....	40
<b>5</b> Getting Integrated Help .....	40
<b>6</b> Using a USB Mouse .....	41
<b>7</b> Using Remote Mouse Receiver .....	42

8	Correcting Horizontal and Vertical Keystone Distortion (Cornerstone) .....	43
9	Making Freehand Drawings on a Projected Image (ChalkBoard) .....	46
10	Storing Images Displayed on the Projector on the PC card or USB Memory (Capture) .....	47
11	Preventing Unauthorized Use of the Projector .....	48
12	Using a USB Memory Device or USB Memory Card Reader .....	53
13	Operation Using an HTTP Browser .....	54
14	Using the Projector to Operate a Computer Connected on a Network (Desktop Control Utility 1.0) .....	57
<b>5. Using the Viewer .....</b>		<b>62</b>
1	Making the Most out of the Viewer Function .....	63
2	Operating the Viewer Function from the Projector (playback) .....	64
3	Changing Background Logo .....	70
<b>6. Using On-Screen Menu .....</b>		<b>71</b>
1	Using the Menus .....	72
2	Menu tree .....	73
3	Menu Elements .....	75
4	Menu Descriptions & Functions [Source] .....	76
5	Menu Descriptions & Functions [Adjust] .....	79
6	Menu Descriptions & Functions [Setup] .....	90
7	Menu Descriptions & Functions [Information] .....	112
8	Menu Descriptions & Functions [Reset] .....	116
<b>7. Maintenance .....</b>		<b>117</b>
1	Cleaning the Cabinet .....	118
2	Cleaning the Lens .....	118
3	Replacing the Lamp .....	119
<b>8. Appendix .....</b>		<b>122</b>
1	Troubleshooting .....	123
2	Specifications .....	126
3	Cabinet Dimensions .....	128
4	Pin Assignments of D-Sub COMPUTER 1/2 Input Connector .....	129
5	Compatible Input Signal List .....	130
6	PC Control Codes and Cable Connection .....	131
7	Using Software Keyboard .....	132
8	Troubleshooting Check List .....	133
9	TravelCare Guide .....	135

# 1

## ***Introduction***

.....

① What's in the Box? .....	2
② Introduction to the Projector .....	3
③ Part Names of the Projector .....	5
Carrying the Projector .....	5
Top Features .....	7
Terminal Panel Features .....	8
④ Part Names of the Remote Control .....	10
Battery Installation .....	12
Operating Range for Wireless Remote Control .....	12
Remote Control Precautions .....	12



# 1 What's in the Box?

Make sure your box contains everything listed. If any pieces are missing, contact your dealer. Please save the original box and packing materials if you ever need to ship your Projector.

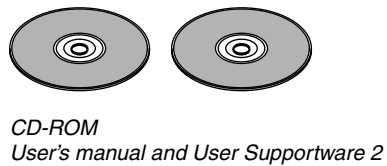
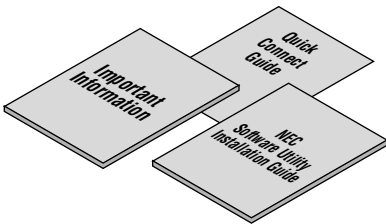
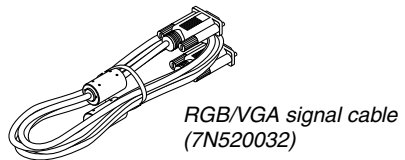
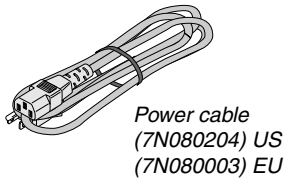
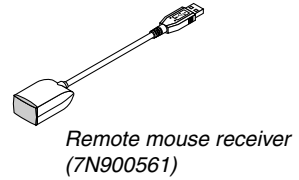
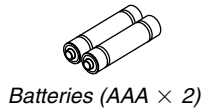
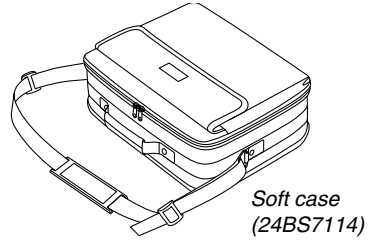
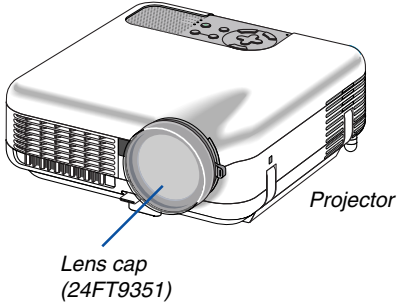

**For North America only**  
Registration card  
Limited warranty

**For Europe only**  
Guarantee policy

• Security sticker

## **2 Introduction to the Projector**

This section introduces you to the LT265/LT245 Projector and describes key features and controls.

### **Congratulations on Your Purchase of the LT265/LT245 Projector**

The LT265/LT245 is a sophisticated XGA projector that produces an enhanced display. With the LT265/LT245 you will be able to project images up to 500" (measured diagonally). Enjoy crisp and sharp large screen display from your PC, workstation or Macintosh computer, DVD player, VCR, satellite hookup, HDTV source, ) and images from your digital camera PC Card, compact flash memory or USB storage device. The LT265/LT245 provides for enhanced security options to help deter projector theft and provides for full projector control through the PC control port (mini DIN 8Pin) and LAN support. With input and output flexibility, long lamp life and a full function remote, the LT265/LT245 lets you enjoy larger than life viewing from a compact and easy to setup and use projector.

### **Features you'll enjoy on the LT265/LT245:**

- Automatic vertical keystone correction for fast and easy application setup.
- 3D Reform™ enhanced image technology for increased projector placement versatility that provides for horizontal, vertical and diagonal keystone correction.
- Built-in Wall Color Correction presets provide for adaptive color correction when projecting onto non-white screen material (or a wall).
- USB memory or PC card interfaces provide for computer-free presentations.
- Enhanced smart security settings for password protection, cabinet control panel lock, menu lock and PC card protection key to help prevent unauthorized access, adjustments and theft deterrence.
- High resolution display - up to UXGA compatible, XGA native resolution.
- Variable audio out control of external amplified speakers via the projector remote.
- Extensive user adjustable picture and color management settings.
- Display 16:9 or 4:3 aspect ratio sources and fill the screen.
- HDTV (1080i, 720p) and SDTV (480p/576p, 480i/576i) compatibility.
- Digital photo viewer to display larger than life images from your digital cameras PC card, compact flash card or USB storage device.
- Integrated RJ-45 connector for wired networking capability.
- Wireless networking capable.  
Present from anywhere in the room when using as a wireless LAN projector, no physical signal cable connection to a PC is required.  
\* The NEC optional wireless LAN card is required (NWL-100\* See page 99.).
- Supplied User Supportware 2 CD-ROM containing five software utilities allowing you to make the most of your NEC projector.
- The supplied wireless remote control and remote mouse receiver allows you to operate your PC mouse wireless from across the room. The remote mouse receiver supports most PCs with USB interface.
- Easy set up, use and operation.
- Eco-mode lamp technology for increased lamp life, reduced energy consumption and overall total cost of ownership savings.
- Built-in laser pointer on the supplied remote control allows you to draw your audience's attention in a presentation.

- Free downloadable Software Geometric Correction Tool 2.0.  
Corrects the geometry of an image projected onto a cylindrical, spherical or corner screen via serial connection.  
For additional information visit:  
US : <http://www.necvisualsystems.com>  
Europe : <http://www.neceurope.com/>  
Global : <http://www.nec-pj.com/>

### **About this user's manual**

The fastest way to get started is to take your time and do everything right the first time. Take a few minutes now to review the user's manual. This may save you time later on. At the beginning of each section of the manual you'll find an overview. If the section doesn't apply, you can skip it.

- IBM is a trademark or registered trademark of International Business Machines Corporation.
- Mac, Macintosh and PowerBook are trademarks of Apple Computer, Inc., registered in the U.S. and other countries.
- Windows, Windows 98, Windows Me, Windows XP or Windows 2000 are trademarks or registered trademarks of Microsoft Corporation.
- Digital Light Processing, DLP, Digital Micromirror Device and DMD are trademarks of Texas Instruments.
- Ulead is a trademark and/or registered trademark of Ulead Systems, Inc.
- Other product and company names mentioned in this user's manual may be the trademarks or registered trademarks of their respective holders.

### 3 Part Names of the Projector

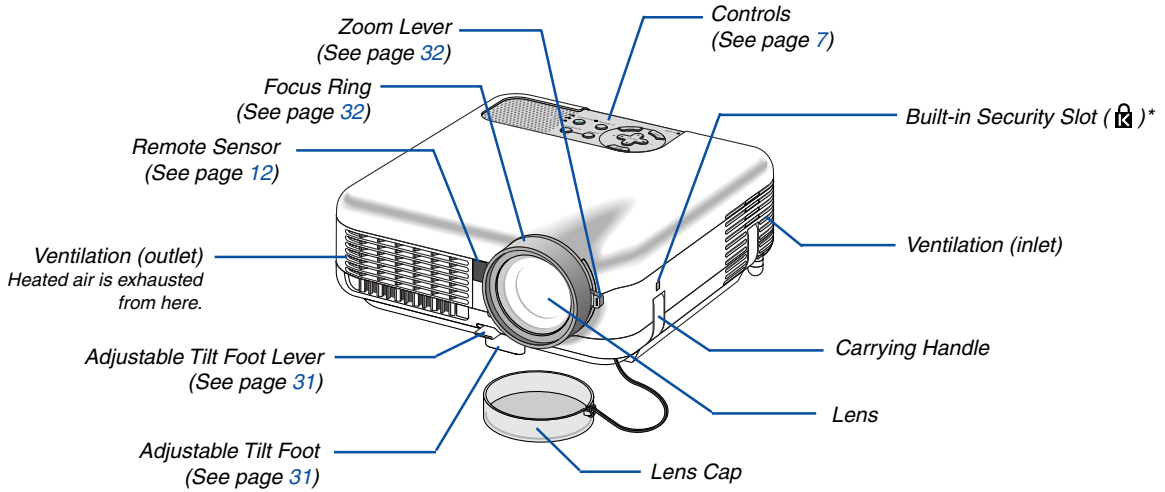

\* This security slot supports the MicroSaver® Security System. MicroSaver® is a registered trademark of Kensington Microware Inc. The logo is trademarked and owned by Kensington Microware Inc.

### Carrying the Projector

Always carry your projector by the handle.

Ensure that the power cable and any other cables connecting to video sources are disconnected before moving the projector.

When moving the projector or when it is not in use, cover the lens with the lens cap.

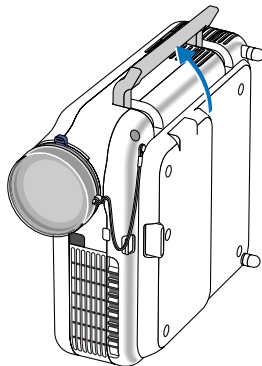

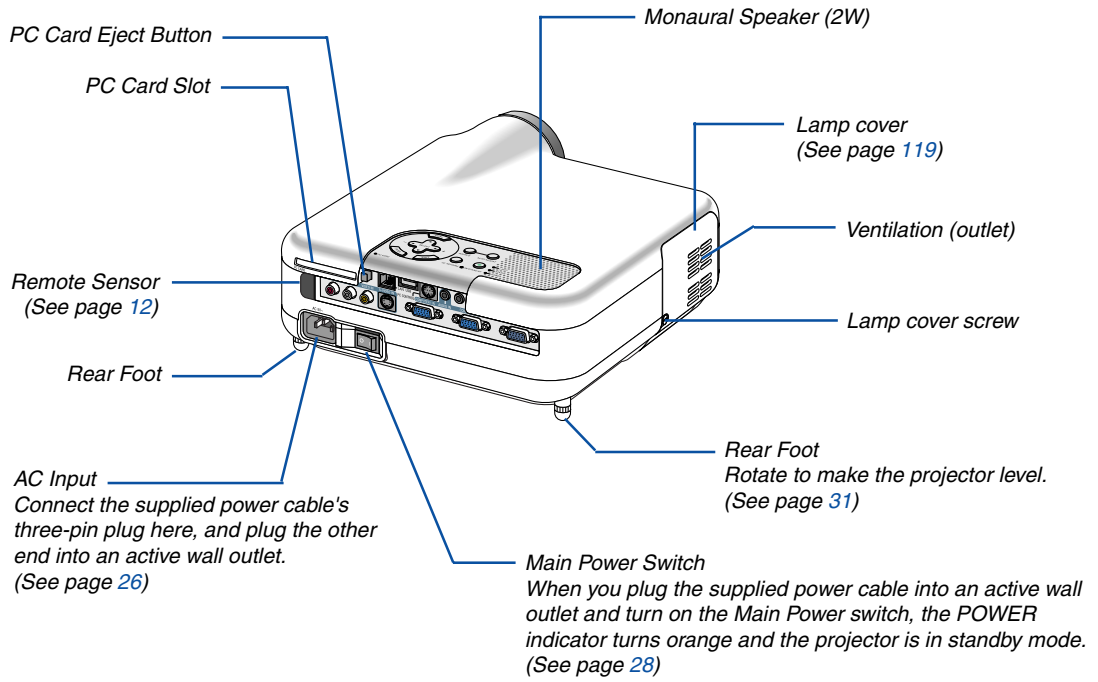

Top Features

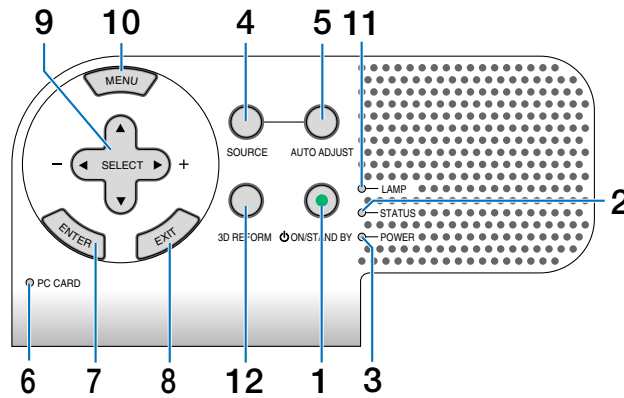

1. POWER Button (ON / STAND BY)

Use this button to turn the power on and off when the main power is supplied and the projector is in standby mode.

*NOTE: To turn on the projector, press and hold this button for a minimum of two seconds. To turn off the projector, press this button twice.*

2. STATUS Indicator

If this light blinks red rapidly, it indicates that an error has occurred, the lamp cover is not attached properly or the projector has overheated. If this light remains orange, it indicates that you have pressed a cabinet key while the Cabinet Button Lock is enabled. See the Status Indicator section on page 123 for more details.

3. POWER Indicator ( )

When this indicator is green, the projector is on; when this indicator is orange, it is in standby mode. See the Power Indicator section on page 123 for more details.

4. SOURCE Button

Use this button to select a video source such as a PC, VCR, DVD player or Viewer (PC card). Press and release this button quickly to display the Source List.

Each time this button is pressed for a minimum of ONE second, the input source will change as follows:

Computer1 → Computer2 → Video → S-Video → Viewer → Computer1 → ...

If no input signal is present, the input will be skipped.

5. AUTO ADJUST Button

Use this button to adjust an RGB source for an optimal picture (See page 35).

6. PC CARD Access Indicator

Lights while accessing a PC card.

7. ENTER Button

Executes your menu selection and activates items selected from the menu.

8. EXIT Button

Pressing this button will return to the previous menu with saving changes. While you are in the main menu, pressing this button will close the menu.

9. SELECT ▲▼◀▶ (+) (-) / Volume Buttons

- ▲▼ : Use these buttons to select the menu of the item you wish to adjust.
- ◀▶ : Use these buttons to change the level of a selected menu item. When no menus appear, these buttons work as a volume control.

When the pointer is displayed, these ▲▼◀▶ buttons move the pointer.

10. MENU Button

Displays the menu.

11. LAMP Indicator

If this light blinks red rapidly, it's warning you that the projection lamp has exceeded 2000 hours (up to 4000 hours in Eco mode) of service. After this light appears, replace the lamp as soon as possible. (See page 119). If this is lit green continually, it indicates that the lamp mode is set to Eco. See the Lamp Indicator section on page 123 for more details.

12. 3D REFORM Button

Press this button to enter 3D Reform mode to correct the keystone (trapezoidal) distortion, and make the image square.

## Terminal Panel Features

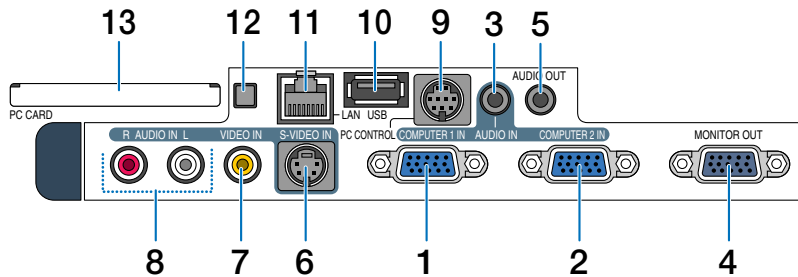

### 1. COMPUTER 1 IN / Component Input Connector (Mini D-Sub 15 Pin)

Connect your computer or other analog RGB equipment such as IBM compatible or Macintosh computers. Use the supplied RGB/VGA signal cable to connect to your computer. This also serves as a component video output of component equipment such as a DVD player. This connector also supports SCART output signal. See page 18 for more details.

### 2. COMPUTER 2 IN / Component Input Connector (Mini D-Sub 15 Pin)

This connector has the same function as the COMPUTER 1 IN connector.

*NOTE: The COMPUTER 2 IN does not support SCART output signal and Plug & Play.*

### 3. COMPUTER AUDIO IN Mini Jack (Stereo Mini)

This is where you connect audio output from your computer or DVD player. A commercially available audio cable is required.

### 4. MONITOR OUT Connector (Mini D-Sub 15 Pin)

You can use this connector to loop your computer image to an external monitor from the COMPUTER 1 or 2 input source.

The RGB analog signal set on “OUT Terminal” is output during Standby mode. See pages 19 and 109.

### 5. AUDIO OUT Mini Jack (Stereo Mini)

Connect an additional audio equipment here to listen to audio coming from your computer, Video or S-Video input.

- Output sound level can be adjusted in accordance with the sound level of the internal speaker.
- When audio equipment is connected, the projector speaker is disabled.
- This jack cannot be used as a headphone jack.

### 6. S-VIDEO IN Connector (Mini DIN 4 Pin)

Here is where you connect the S-Video input from an external source like a VCR.

*NOTE: S-Video provides more vivid color and higher resolution than the traditional composite video format.*

### 7. VIDEO IN Connector (RCA)

Connect a VCR, DVD player, laser disc player, or document camera here to project video.

### 8. VIDEO AUDIO IN Jacks (RCA)

L: This is your left channel audio input for stereo sound coming from the VIDEO source.

R: This is your right channel audio input for stereo sound from the VIDEO source.

### 9. PC CONTROL Port (Mini DIN 8 Pin)

Use this port to connect your PC or control system to control your projector via a serial cable. This enables you to control the projector using serial communication protocol. The NEC optional serial cable (CA03D) is required to use this port. You can also control the projector by using PC Control Utility 3.0 contained on the supplied User Supportware 2 CD-ROM.

To do so you must first have PC Control Utility 3.0 installed on your PC. If you are writing your own program, typical PC control codes are on page 131.

### 10. USB Port (Type A)

Connect a commercially available USB memory device or mouse that supports USB. You can operate the menu or Viewer with the USB mouse via this port. Note that this port should not be connected to a computer and that there may be some brands of USB mouse that the projector does not support.

### 11. LAN Port (RJ-45)

This port is typically used for UTP Ethernet/Fast Ethernet. Use this connector to control the projector on a LAN. See page 22.

## Terminal Panel Features

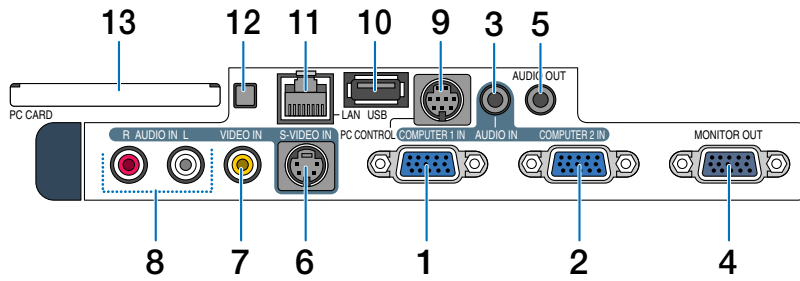

### 12. PC CARD Eject Button

Press to eject a PC card partially.

### 13. PC CARD Slot

Insert a PC memory card or NEC optional wireless LAN card here.



## 4 Part Names of the Remote Control

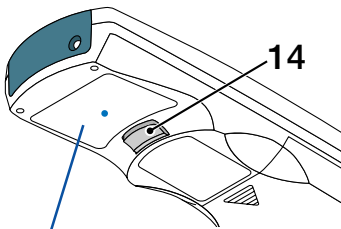
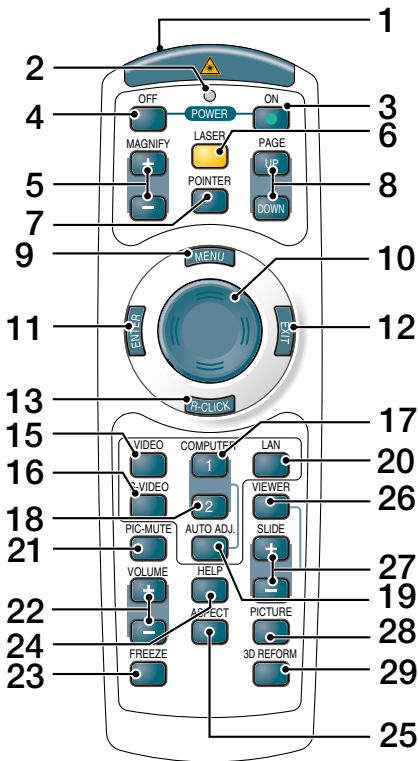

### 1. Infrared Transmitter/Laser Pointer

Transmits an infrared signal when any button other than LASER is pressed.

Direct the remote control toward the remote sensor on the projector cabinet.

Beams a laser light when the Laser button is pressed.

#### CAUTION:

- \* Do not look into the laser pointer while it is on.
- \* Do not point the laser beam at a person.

### 2. LED

Flashes when any button is pressed.

### 3. POWER ON Button

When the main power is on, you can use this button to turn your projector on.

*NOTE: To turn on the projector, press and hold the POWER ON button for a minimum of two seconds.*

### 4. POWER OFF Button

You can use this button to turn your projector off.

*NOTE: To turn off the projector, press the POWER OFF button twice.*

### 5. MAGNIFY (+)(-) Buttons

Use these buttons to adjust the image size.

The image can be magnified about the center of the screen up to 400%. See page 40.

### 6. LASER Button

Press and hold this button to activate the laser pointer. When lit, you can use the laser to draw your audience's attention to a red dot that you can place on any object.

### 7. POINTER Button

Press this button to display the projector pointer. You can move your pointer icon to the area you want on the screen using the Select button. See page 39.

### 8. PAGE UP/DOWN Buttons

Use these buttons to operate your computer with the supplied remote mouse receiver. You can use these buttons to scroll the viewing area of the window or to move to the previous or next slide in PowerPoint on your computer.

### 9. MENU Button

Displays the menu for various settings and adjustments.

### 10. Select Button

This button is used for projector's menu operation and moving the magnified image.

This button also works as a computer mouse when the supplied remote mouse receiver is connected with your computer. See page 42.

### 11. ENTER Button

Executes your menu selection and activates items selected from the menu.

### 12. EXIT Button

Returns to the previous menu.

While you are in the main menu, pressing this button will close the menu.

### 13. R-CLICK Button

Works as the mouse right button when the supplied remote mouse receiver is connected with your computer.

### 14. L-CLICK Button

Works as the mouse left button when the supplied remote mouse receiver is connected with your computer.

### 15. VIDEO Button

Press this button to select a video source from a VCR, DVD player, laser disc player or document camera.

### 16. S-VIDEO Button

Press this button to select an S-Video source from a VCR.

### 17. COMPUTER 1 Button

Press this button to select COMPUTER 1 input.

### 18. COMPUTER 2 Button

Press this button to select COMPUTER 2 input.

### 19. AUTO ADJ. Button

Use this button to adjust an RGB source (COMPUTER 1 or 2) for an optimal picture. See page 35.

### 20. LAN Button

Press this button to select the LAN (Local Area Network) connection.

### 21. PIC-MUTE Button

This button turns off the image and sound for a short period of time. Press again to restore the image and sound. See page 39.

### 22. VOLUME +/- Buttons

Press (+) to increase the volume and (-) to decrease it. See page 35.

### 23. FREEZE Button

This button will freeze a picture. Press again to resume motion. See page 39.

### 24. HELP Button

Provides the Information screen. See page 40.

### 25. ASPECT Button

Press this button to display the Aspect Ratio select menu. See page 81.

### 26. VIEWER Button

Press this button to select the Viewer source. See page 64.

### 27. SLIDE +/- Buttons

Press (+) to select the next folder or slide and press (-) to select the previous folder or slide.

### 28. PICTURE Button

Press to display the picture adjustment screen. Pressing this button sequentially selects "Brightness" → "Contrast" → "Color" → "Hue" → "Sharpness" → "Wall Color". See pages 79 and 80.

### 29. 3D REFORM Button

Press this button to enter 3D Reform to correct the keystone (trapezoidal) distortion, and make the image square. See pages 33 and 43.

## Battery Installation

- 1** Remove the battery cover.  
*NOTE: Do not pull the battery cover by force. Doing so can result in it coming off.*

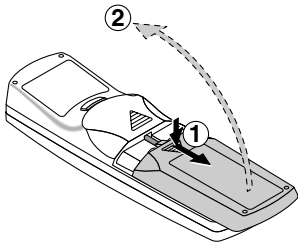

- 2** Remove both old batteries and install new ones (AAA). Ensure that you have the batteries' polarity (+/-) aligned correctly.

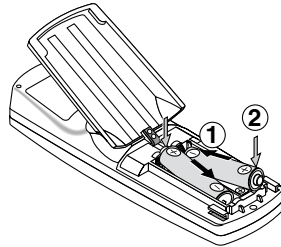

- 3** Slip the cover back over the batteries until it snaps into place.  
*NOTE: Do not mix different types of batteries or new and old batteries.*

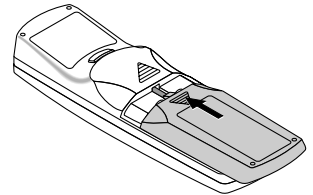

## Operating Range for Wireless Remote Control

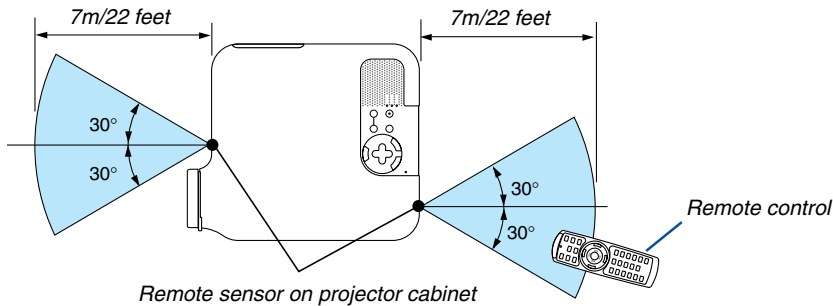

- The infrared signal operates by line-of-sight up to a distance of about 22 feet/7 m and within a 60-degree angle of the remote sensor on the projector cabinet.
  - The projector will not respond if there are objects between the remote control and the sensor, or if strong light falls on the sensor.
- Weak batteries will also prevent the remote control from properly operating the projector.

## Remote Control Precautions

- Handle the remote control carefully.
- If the remote control gets wet, wipe it dry immediately.
- Avoid excessive heat and humidity.
- If you will not be using the remote control for a long time, remove the batteries.
- Do not place the batteries upside down.
- Do not use new and old batteries together, or use different types of batteries together.
- Dispose of used batteries according to your local regulations.

# 2

## ***Installation and Connections***



<b>1</b>	<b>Setting Up the Screen and the Projector .....</b>	<b>14</b>
	Selecting a Location .....	14
	Throw Distance and Screen Size .....	15
<b>2</b>	<b>Making Connections .....</b>	<b>17</b>
	Enabling the computer's external display .....	17
	Connecting Your PC or Macintosh Computer .....	17
	To connect SCART output (RGB) .....	18
	Connecting an External Monitor .....	19
	Connecting Your DVD Player with Component Output .....	20
	Connecting Your VCR or Laser Disc Player .....	21
	Connecting to a Network .....	22
	Inserting and Removing a PC Card .....	24
	Connecting the Supplied Power Cable .....	26

## 2. Installation and Connections

This section describes how to set up your projector and how to connect PCs, video and audio sources.

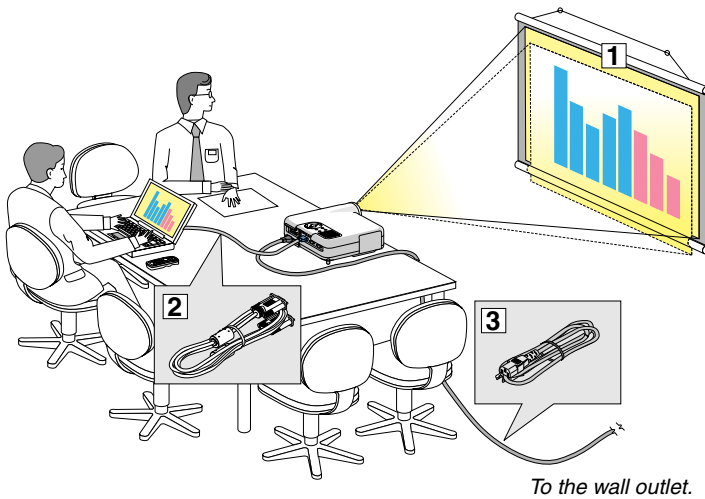

Your projector is simple to set up and use. But before you get started, you must first:

- 1 Set up a screen and the projector.
- 2 Connect your computer or video equipment to the projector. See pages 17 - 25.
- 3 Connect the supplied power cable. See page 26.

**NOTE:** Ensure that the power cable and any other cables are disconnected before moving the projector. When moving the projector or when it is not in use, cover the lens with the lens cap.

### 1 Setting Up the Screen and the Projector

#### Selecting a Location

The further your projector is from the screen or wall, the larger the image. The minimum size the image can be is approximately 30 inches (0.8 m) measured diagonally when the projector is roughly 51.2 inches (1.3 m) from the wall or screen. The largest the image can be is 500 inches (12.7 m) when the projector is about 970 inches (24.6 m) from the wall or screen. Use the drawing below as a guide.

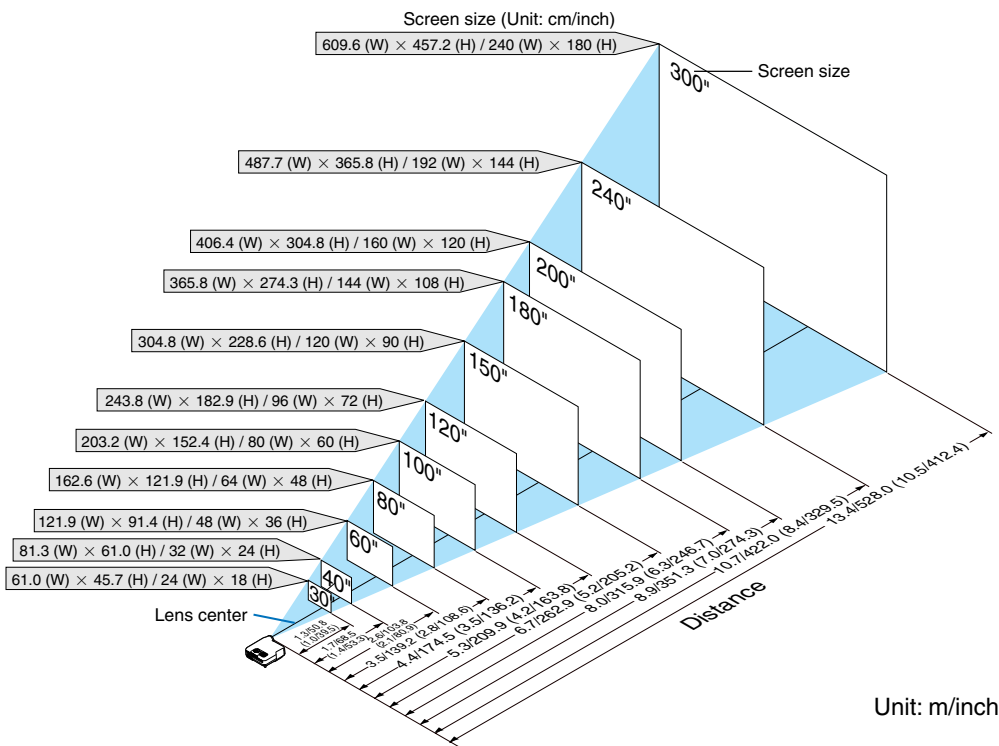

**NOTE:**

- Values in parentheses for LT245.
- The screen sizes above are intermediate values between tele (minimum display area) and wide (maximum display area). Image size can be adjusted with the zoom adjustment up to a maximum of 10%.
- To avoid premature lamp failure, do not tilt the front of the projector up or down by more than 7° from level.

## 2. Installation and Connections

### Throw Distance and Screen Size

The following shows the proper relative positions of the projector and screen. Refer to the table to determine the position of installation.

### Distance Chart

B = Vertical distance between lens center and screen center

C = Throw distance

D = Vertical distance between lens center and bottom of screen (top of screen for ceiling application)

$\alpha$  = Throw angle

*NOTE: Distances may vary +/-5%.*

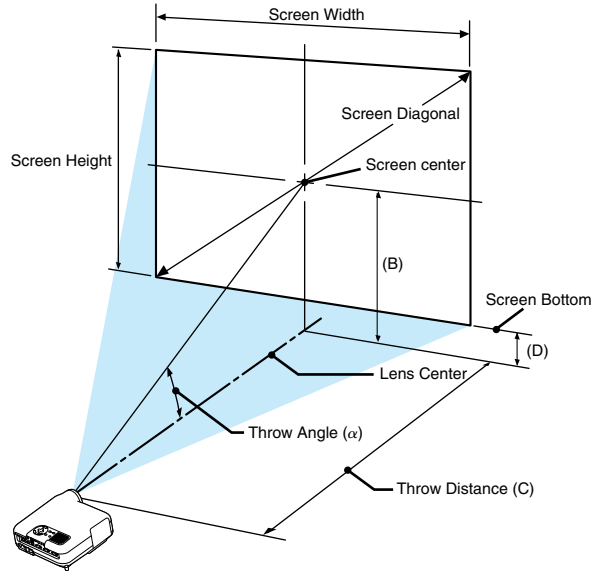

### LT265

Screen Size			B	C		D	$\alpha$	
Diagonal	Width	Height		Wide - Tele			Wide - Tele	
inch	inch	inch	inch	inch		inch	degree	
30	24	18	12.6	45.6	56.0	3.6	15.4	12.7
40	32	24	16.8	61.5	75.4	4.8	15.3	12.6
60	48	36	25.2	93.5	114.1	7.2	15.1	12.5
67	54	40	28.1	104.7	127.7	8.0	15.0	12.4
72	58	43	30.2	112.7	137.4	8.6	15.0	12.4
80	64	48	33.6	125.5	152.9	9.6	15.0	12.4
84	67	50	35.3	131.9	160.6	10.1	15.0	12.4
90	72	54	37.8	141.5	172.2	10.8	15.0	12.4
100	80	60	42.0	157.4	191.6	12.0	14.9	12.4
120	96	72	50.4	189.4	230.3	14.4	14.9	12.3
150	120	90	63.0	237.3	288.4	18.0	14.9	12.3
180	144	108	75.6	285.3	346.6	21.6	14.8	12.3
200	160	120	84.0	317.2	385.3	24.0	14.8	12.3
210	168	126	88.2	333.2	404.7	25.2	14.8	12.3
240	192	144	100.8	381.2	462.8	28.8	14.8	12.3
261	209	157	109.7	414.7	503.4	31.4	14.8	12.3
270	216	162	113.5	429.1	520.9	32.5	14.8	12.3
300	240	180	126.1	477.0	579.0	36.1	14.8	12.3
350	280	210	147.1	557.0	675.8	42.1	14.8	12.3
400	320	240	168.1	636.9	772.7	48.1	14.8	12.3
450	360	270	189.1	716.8	869.5	54.1	14.8	12.3
500	400	300	210.1	796.7	966.4	60.1	14.8	12.3

Screen Size			B	C		D	$\alpha$	
Diagonal	Width	Height		Wide - Tele			Wide - Tele	
inch	mm	mm	mm	mm		mm	degree	
30	762	610	457	320	1,157	-1,423	91	15.4 - 12.7
40	1016	813	610	427	1,563	-1,915	122	15.3 - 12.6
60	1524	1219	914	640	2,375	-2,899	183	15.1 - 12.5
67	1702	1361	1021	714	2,659	-3,243	204	15.0 - 12.4
72	1829	1463	1097	768	2,862	-3,489	219	15.0 - 12.4
80	2032	1626	1219	853	3,187	-3,883	244	15.0 - 12.4
84	2134	1707	1280	896	3,349	-4,080	256	15.0 - 12.4
90	2286	1829	1372	960	3,593	-4,375	274	15.0 - 12.4
100	2540	2032	1524	1067	3,999	-4,867	305	14.9 - 12.4
120	3048	2438	1829	1280	4,811	-5,851	366	14.9 - 12.3
150	3810	3048	2286	1601	6,028	-7,327	458	14.9 - 12.3
180	4572	3658	2743	1921	7,246	-8,802	549	14.8 - 12.3
200	5080	4064	3048	2134	8,058	-9,786	610	14.8 - 12.3
210	5334	4267	3200	2241	8,464	-10,278	641	14.8 - 12.3
240	6096	4877	3658	2562	9,682	-11,754	733	14.8 - 12.3
261	6629	5304	3978	2786	10,534	-12,787	797	14.8 - 12.3
270	6858	5486	4115	2882	10,899	-13,230	824	14.8 - 12.3
300	7620	6096	4572	3202	12,117	-14,706	916	14.8 - 12.3
350	8890	7112	5334	3736	14,147	-17,166	1069	14.8 - 12.3
400	10160	8128	6096	4270	16,176	-19,626	1222	14.8 - 12.3
450	11430	9144	6858	4804	18,206	-22,086	1375	14.8 - 12.3
500	12700	10160	7620	5337	20,235	-24,545	1527	14.8 - 12.3

### LT245

Screen Size			B	C		D	$\alpha$	
Diagonal	Width	Height		Wide - Tele			Wide - Tele	
inch	inch	inch	inch	inch		inch	degree	
30	24	18	12.5	35.7	43.3	3.5	19.4	16.2
40	32	24	16.7	48.2	58.4	4.7	19.1	16.0
60	48	36	25.1	73.3	88.5	7.1	18.9	15.9
67	54	40	28.1	82.1	99.1	8.0	18.9	15.8
72	58	43	30.2	88.4	106.6	8.6	18.8	15.8
80	64	48	33.5	98.5	118.7	9.5	18.8	15.8
84	67	50	35.2	103.5	124.7	10.0	18.8	15.8
90	72	54	37.7	111.0	133.7	10.7	18.8	15.8
100	80	60	41.9	123.6	148.8	11.9	18.7	15.7
120	96	72	50.3	148.7	178.9	14.3	18.7	15.7
150	120	90	62.9	186.3	224.1	17.9	18.7	15.7
180	144	108	75.5	224.0	269.3	21.5	18.6	15.7
200	160	120	83.9	249.1	299.5	23.9	18.6	15.7
210	168	126	88.1	261.7	314.5	25.1	18.6	15.7
240	192	144	100.7	299.3	359.7	28.7	18.6	15.6
261	209	157	109.5	325.7	391.4	31.2	18.6	15.6
270	216	162	113.3	337.0	405.0	32.3	18.6	15.6
300	240	180	125.9	374.6	450.2	35.9	18.6	15.6
350	280	210	146.9	437.4	525.5	41.9	18.6	15.6
400	320	240	167.9	500.2	600.8	47.9	18.6	15.6
450	360	270	188.9	563.0	676.2	53.9	18.5	15.6
500	400	300	209.9	625.7	751.5	59.9	18.5	15.6

Screen Size			B	C		D	$\alpha$	
Diagonal	Width	Height		Wide - Tele			Wide - Tele	
inch	mm	mm	mm	mm		mm	degree	
30	762	610	457	319	906	-1,100	90	19.4 - 16.2
40	1016	813	610	425	1,225	-1,483	120	19.1 - 16.0
60	1524	1219	914	639	1,863	-2,248	181	18.9 - 15.9
67	1702	1361	1021	713	2,086	-2,516	203	18.9 - 15.8
72	1829	1463	1097	766	2,246	-2,707	218	18.8 - 15.8
80	2032	1626	1219	852	2,501	-3,014	242	18.8 - 15.8
84	2134	1707	1280	894	2,628	-3,167	254	18.8 - 15.8
90	2286	1829	1372	958	2,820	-3,396	273	18.8 - 15.8
100	2540	2032	1524	1065	3,139	-3,779	303	18.7 - 15.7
120	3048	2438	1829	1278	3,776	-4,545	364	18.7 - 15.7
150	3810	3048	2286	1598	4,733	-5,693	455	18.7 - 15.7
180	4572	3658	2743	1918	5,689	-6,841	547	18.6 - 15.7
200	5080	4064	3048	2132	6,327	-7,607	608	18.6 - 15.7
210	5334	4267	3200	2238	6,646	-7,989	638	18.6 - 15.7
240	6096	4877	3658	2558	7,603	-9,137	729	18.6 - 15.6
261	6629	5304	3978	2782	8,272	-9,941	793	18.6 - 15.6
270	6858	5486	4115	2878	8,559	-10,286	821	18.6 - 15.6
300	7620	6096	4572	3198	9,516	-11,434	912	18.6 - 15.6
350	8890	7112	5334	3731	11,110	-13,348	1064	18.6 - 15.6
400	10160	8128	6096	4264	12,705	-15,261	1216	18.6 - 15.6
450	11430	9144	6858	4798	14,299	-17,175	1369	18.5 - 15.6
500	12700	10160	7620	5331	15,893	-19,089	1521	18.5 - 15.6

### WARNING

- \* Installing your projector on the ceiling must be done by a qualified technician. Contact your NEC dealer for more information.
- \* Do not attempt to install the projector yourself.
- Only use your projector on a solid, level surface. If the projector falls to the ground, you can be injured and the projector severely damaged.
- Do not use the projector where temperatures vary greatly. The projector must be used at temperatures between 41°F (5°C) and 95°F (35°C).
- Do not expose the projector to moisture, dust, or smoke. This will harm the screen image.

- Ensure that you have adequate ventilation around your projector so heat can dissipate. Do not cover the vents on the side or the front of the projector.

### Reflecting the Image

Using a mirror to reflect your projector's image enables you to enjoy a much larger image. Contact your NEC dealer if you need a mirror system. If you're using a mirror system and your image is inverted, use the MENU and SELECT buttons on your projector cabinet or your remote control to correct the orientation. See page 98.

## ② Making Connections

*NOTE: When using with a notebook PC, be sure to connect between the projector and the notebook PC before turning on the power to the notebook PC. In most cases signal cannot be output from RGB output unless the notebook PC is turned on after connecting with the projector.*

*\* If the screen goes blank while using your remote control, it may be the result of the computer's screen-saver or power management software.*

### Enabling the computer's external display

Displaying an image on the notebook PC's screen does not necessarily mean it outputs a signal to the projector. When using a PC compatible laptop, a combination of function keys will enable/disable the external display. Usually, the combination of the 'Fn' key along with one of the 12 function keys gets the external display to come on or off. For example, NEC laptops use Fn + F3, while Dell laptops use Fn + F8 key combinations to toggle through external display selections.

### Connecting Your PC or Macintosh Computer

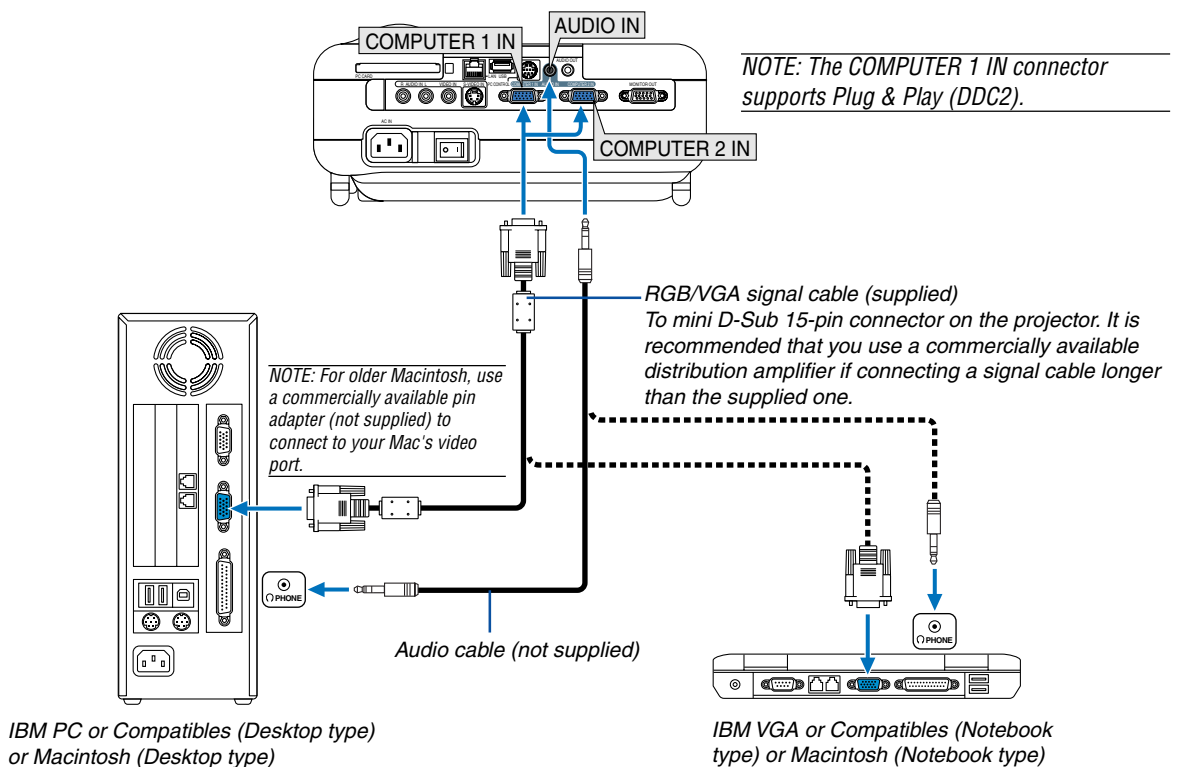

Connecting your PC or Macintosh computer to your projector will enable you to project your computer's screen image for an impressive presentation.

#### To connect to a PC or Macintosh, simply:

1. Turn off the power to your projector and computer.
2. Use the supplied RGB/VGA signal cable to connect your PC or Macintosh to the projector.
3. Connect the supplied power cable. See page 26.
4. Turn on the projector and the computer.
5. If the projector goes blank after a period of inactivity, it may be caused by a screen saver installed on the computer you've connected to the projector.



## 2. Installation and Connections

*NOTE: The LT265/LT245 is not compatible with video decoded outputs of either the NEC ISS-6020 and ISS-6010 switchers.*

*NOTE: An image may not be displayed correctly when a Video or S-Video source is played back via a commercially available scan converter.*

*This is because the projector will process a video signal as a computer signal at the default setting. In that case, do the following.*

- \* *When an image is displayed with the lower and upper black portion of the screen or a dark image is not displayed correctly:  
Project an image to fill the screen and then press the AUTO ADJ button on the remote control or the AUTO ADJUST button on the projector cabinet.*
- \* *When noise appears on the sides of the screen:  
Use the Overscan feature to display the image correctly.  
Be sure to change the Overscan to 0% before pressing the AUTO ADJ or AUTO ADJUST button, otherwise an image may be displayed with its sides cut off.*

### To connect SCART output (RGB)

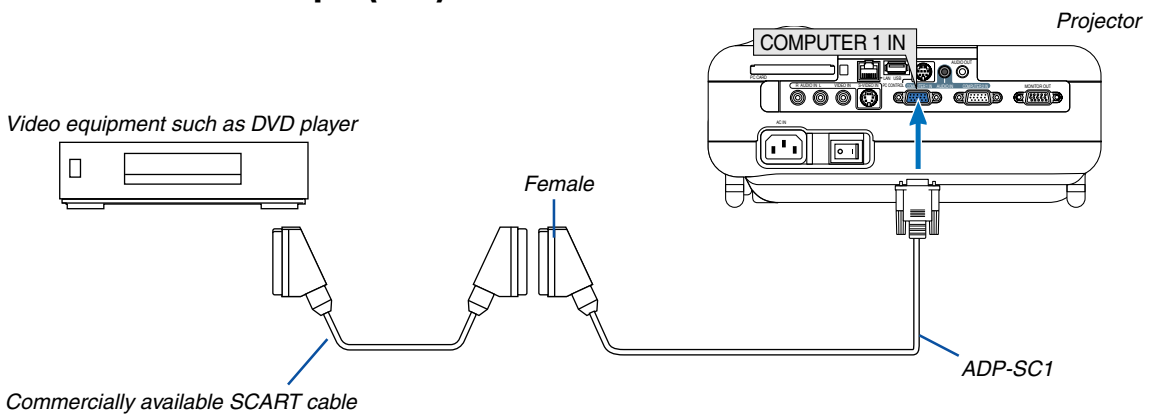

Before connections: An exclusive SCART adapter (ADP-SC1) and a commercially available SCART cable are required for this connection.

*NOTE: Audio signal is not available for this connection.*

1. Turn off the power to the projector and your video equipment.
2. Use the NEC ADP-SC1 SCART adapter and a commercially available SCART cable to connect the COMPUTER 1 IN connector of your projector and a SCART output (RGB) of your video equipment.
3. Connect the supplied power cable. See page 26.
4. Turn on the power to the projector and your video equipment.
5. Use the COMPUTER 1 button on the remote control to select the COMPUTER 1 IN connector.
6. Press the MENU button on the remote control to display the menu.
7. From the menu, select [Setup] → [Options] → [Signal Select] → [Computer 1] → [Scart].  
SCART is a standard European audio-visual connector for TVs, VCRs and DVD players. It is also referred to as Euro-connector.

*NOTE: The ADP-SC1 SCART adapter is obtainable from your NEC dealer in Europe. Contact your NEC dealer in Europe for more information.*

### Connecting an External Monitor

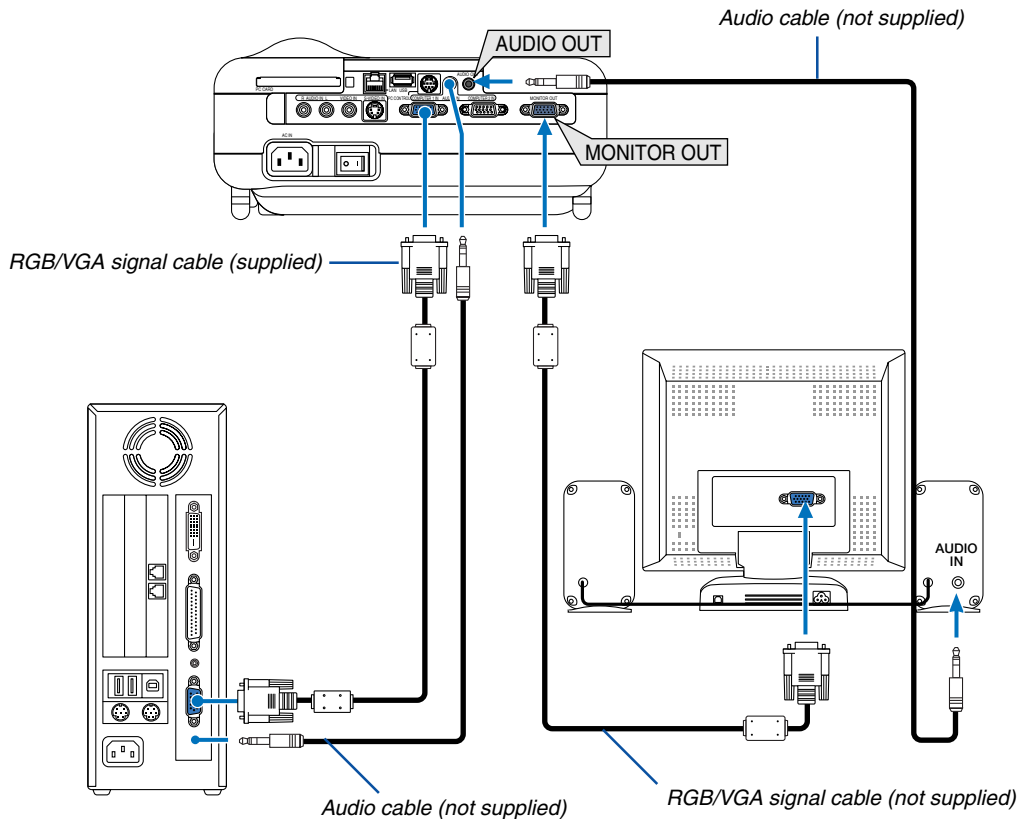

You can connect a separate, external monitor to your projector to simultaneously view on a monitor the RGB analog image you're projecting.

#### To do so:

1. Turn off the power to your projector, monitor and computer.
2. Use an RGB/VGA signal cable to connect your monitor to the MONITOR OUT (Mini D-Sub 15 pin) connector on your projector.
3. Connect the supplied power cable. See page 26.
4. Turn on the projector, monitor and the computer.

#### NOTE:

- The MONITOR OUT connector outputs an RGB signal during Standby mode.
- When the projector is in the standby mode, the image may not be correctly displayed while the cooling fans are running immediately after turning on or off the power.
- Output sound level can be adjusted in accordance with the sound level.
- When audio equipment is connected, the projector speaker is disabled.
- Daisy chain connection is not possible.

### Connecting Your DVD Player with Component Output

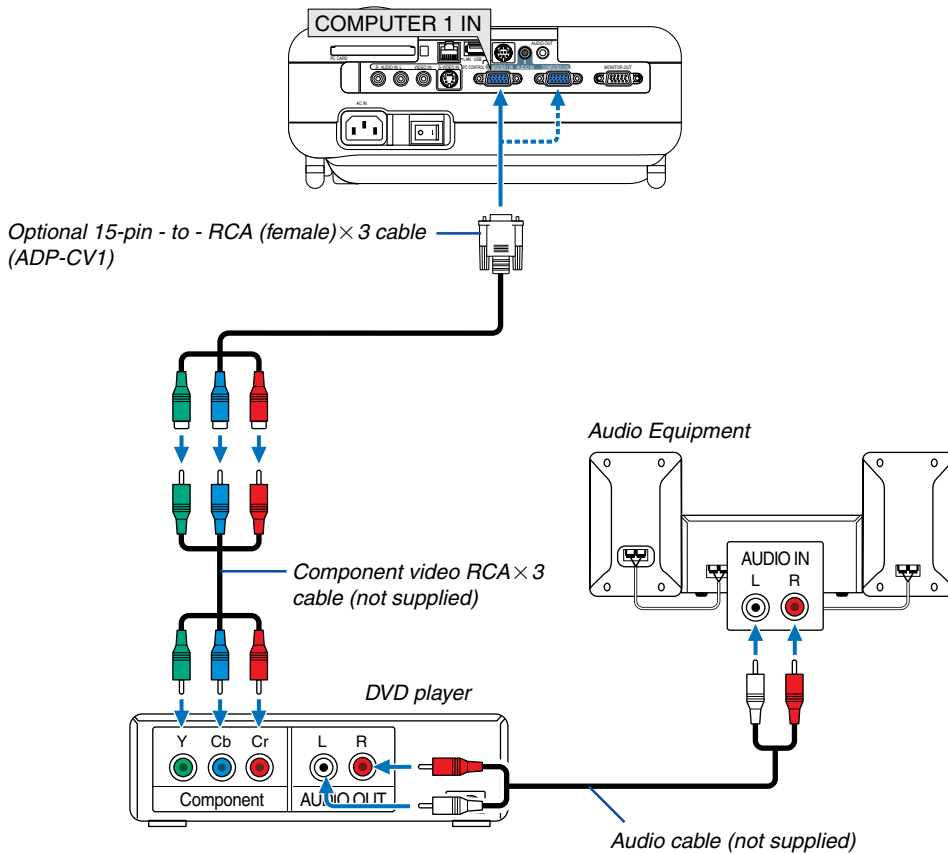

You can connect your projector to a DVD player with component output or Video output. To do so, simply:

1. Turn off the power to your projector and DVD player.
2. If your DVD player has a component video (Y,Cb,Cr) output, use a commercially available component video cable (RCA x 3) and the optional 15-pin-to-RCA (female) x 3 cable to connect your DVD player to the COMPUTER IN connector on the projector.

For a DVD player without component video (Y,Cb,Cr) output, use an S-Video cable (not provided) to connect an S-Video output of the DVD player to the Video Input of the projector.

3. Connect the supplied power cable. See page 26.
4. Turn on the projector and DVD player.

A component signal will be automatically displayed. If not, from the menu, select [Setup] → [Options] → [Signal Select] → [Computer 1 (or 2)] → [Component].

**NOTE:** Refer to your DVD player's owner's manual for more information about your DVD player's video output requirements.

### Connecting Your VCR or Laser Disc Player

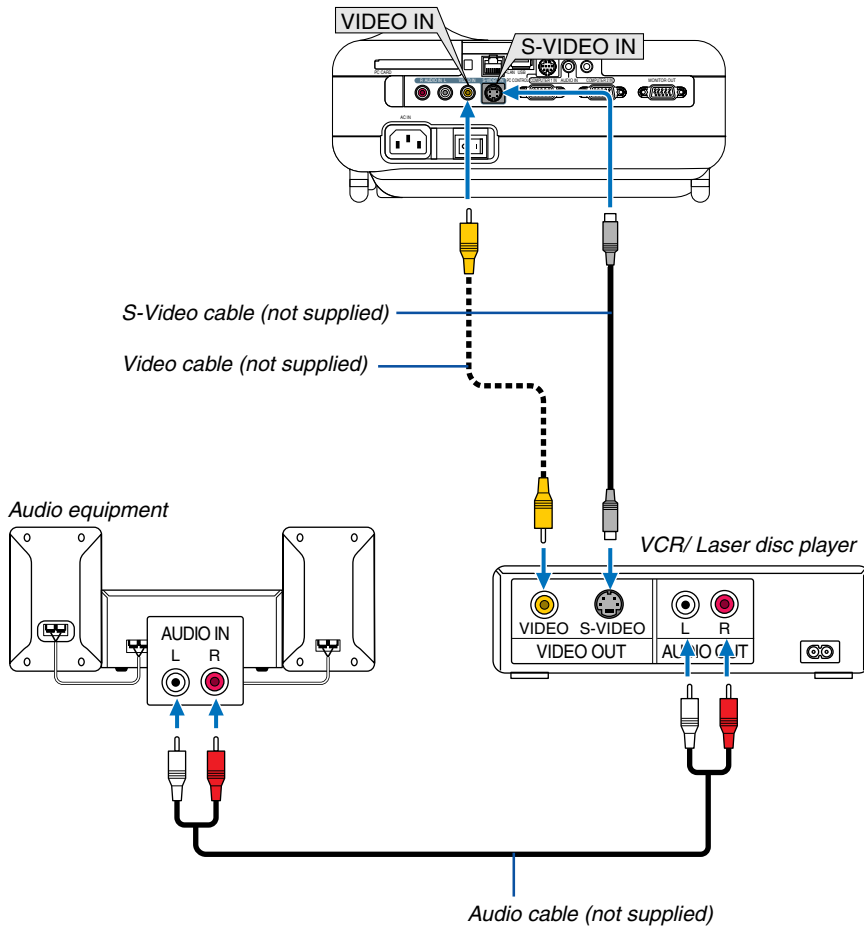

Use an RCA or S-Video cable (not provided) to connect the video and use RCA cables (not provided) to connect the audio from your VCR, laser disc player or document camera to your projector.

#### To make these connections, simply:

1. Turn off the power to the projector and VCR, laser disc player or document camera.
2. Connect one end of an RCA cable to the video output (or one end of an S-Video cable to the S-Video output connector) on the back of your VCR or laser disc player, connect the other end to the appropriate video input on your projector. Connect one end of a pair of RCA cables (not supplied) to the audio output on the back of your VCR or laser disc player, connect the other end to your audio equipment or to the appropriate audio input on the projector.
3. Connect the supplied power cable. See page 26.
4. Turn on the projector and the VCR or laser disc player.

---

*NOTE: Refer to your VCR or laser disc player owner's manual for more information about your equipment's video output requirements.*

---

*NOTE: An image may not be displayed correctly when a Video or S-Video source is played back in fast-forward or fast-rewind via a scan converter.*

---

### Connecting to a Network

The LT265/LT245 comes standard with a LAN port (RJ-45) which provides a LAN connection using a LAN cable. Placing the optional wireless LAN card (NWL-100\*) in the PC card slot of the projector also provides a wireless LAN connection. To use a LAN connection, you are required to assign an IP address to the projector. For setting the LAN mode, see page 99 (From the menu, select [Setup] → [Installation] → [LAN Mode])

With the LAN connection, two features are available: Projector control and Picture transmission.

### Projector control feature

With the wired or wireless LAN connection, you can control (power on/off, input select, etc.) and receive information from the projector over the network using a computer. The following two methods are available:

- \* Using the HTTP Server feature on the projector. See page 54.
- \* Using PC Control Utility 3.0 from the supplied User Supportware 2 CD-ROM.

### Picture transmission feature

With the wired or wireless LAN connection, you can send images and slides from a personal computer to the projector which then can be projected on the screen. The following two methods are available:

- \* Using Image Express Utility 2.0 from the supplied User Supportware 2 CD-ROM.
- \* Using Ulead Photo Explore 8.0 from the supplied User Supportware 2 CD-ROM.

With the USB mouse connected to the projector, you can also operate the desktop screen on your Windows PC connected to the LAN or the wireless LAN.

- \* Using Desktop Control Utility 1.0 from the supplied User Supportware 2 CD-ROM.

---

*NOTE: For information about the five software utilities (Image Express Utility 2.0, Desktop Control Utility 1.0, Ulead Photo Explorer 8.0, Viewer PPT Converter and PC Control Utility 3.0) contained on the supplied Projector User Supportware 2.0 CD-ROM, see the supplied "NEC Software Utility Installation Guide". See also each online help of the software utilities for information about their functions and operations.*

---

### Example of LAN connection

(A) Example of wired LAN connection

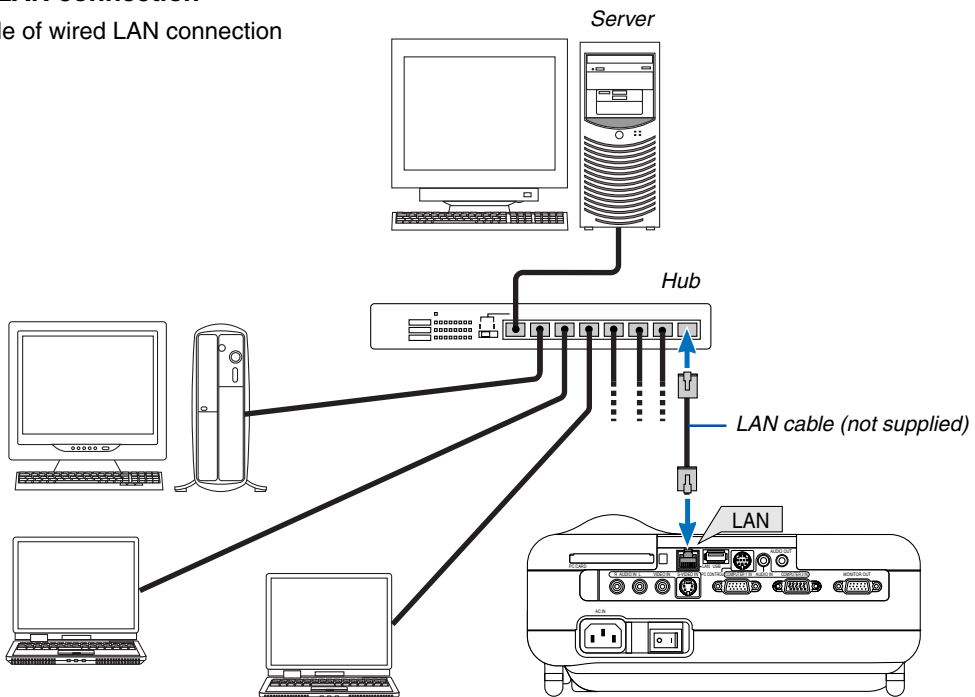

(B) Example of wireless LAN connection  
(Network Type → Mode: Infrastructure)

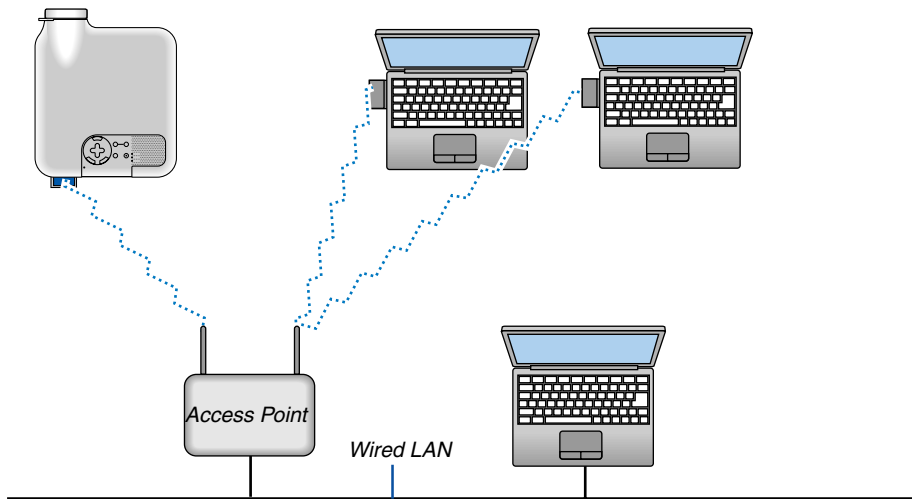

To make connection with a wired LAN via an access point, you need to select the Infrastructure mode. From the menu, select [Setup] → [Installation] → [LAN Mode] → [PC Card] → [Advanced] → [Network Type] → [Infrastructure].

(C) Example of wireless LAN connection (Network Type → Mode: 802.11 Ad Hoc)

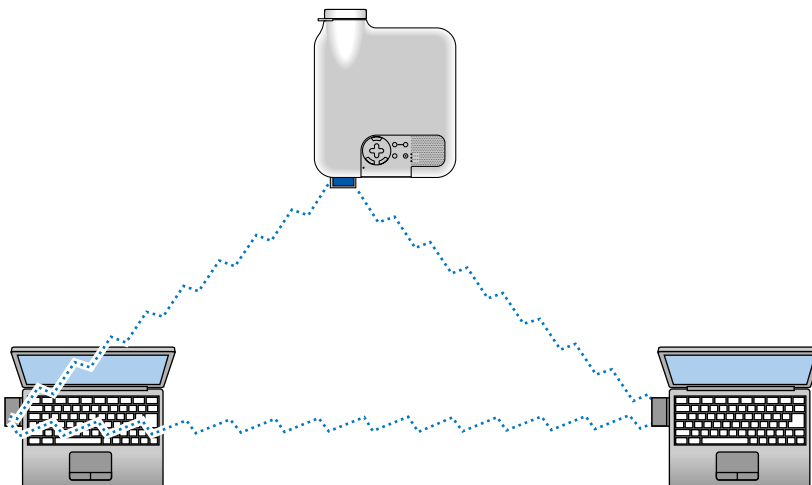

To enable direct communication (i.e., peer-to-peer) between personal computers and projectors, you need to select the 802.11 Ad Hoc mode. From the menu, select [Setup] → [Installation] → [LAN Mode] → [PC Card] → [Advanced] → [Network Type] → [802.11 Ad Hoc].

The 802.11 Ad hoc mode complies with IEEE802.11 standard.

When in Ad Hoc mode, only 802.11b is available for communication method. Data transmission speed in Ad Hoc mode is limited up to 11Mbps.

### Inserting and Removing a PC Card

To insert the NEC optional wireless LAN card or a PC memory card (also referred to as PC card in this manual), follow the steps below.

#### CAUTION:

- \* Direction for Inserting the PC Card

The PC card has a top and bottom and must be inserted into the PC card slot in a specific direction. It cannot be inserted backwards or upside-down.

Attempting to force it into the slot in the wrong direction may break the internal pin and damage the card slot. Refer to the PC card's operating instructions for the proper direction of insertion.

- \* Back up your PC card's data in case it will need to be restored.
- \* To prevent electrostatic discharge damage to the wireless LAN card, wear an anti-static wrist strap. If no wrist strap is available, ground yourself by touching metal such as a door knob.

### Inserting the PC Card

1. Turn off the main power switch before inserting the PC card. (This step is needed only when the wireless LAN card being inserted into the projector's PC CARD slot)
2. Hold the PC card horizontally and insert it slowly into the PC card slot with its top facing up.

The eject button pops out once the PC card is fully inserted. Check that the PC card is fully inserted.

*NOTE: Do not try to force the PC card into the slot or you may bend the pins inside the slot.*

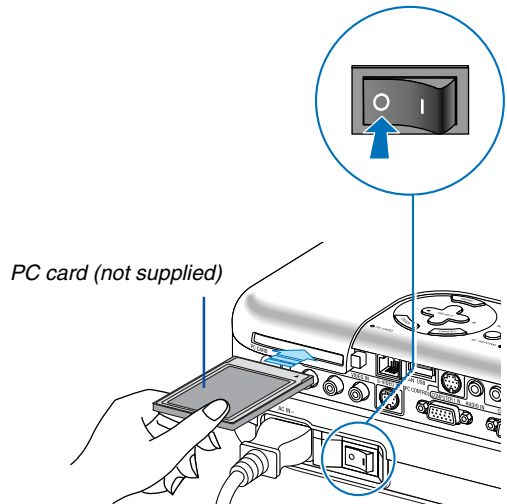

### Removing the PC Card

1. Make sure that the PC CARD access indicator is not lit. (This step is needed only when the PC memory card being inserted into the projector's PC CARD slot.)

*NOTE: The PC CARD access indicator lights while its data is being accessed.*

2. To remove the wireless LAN card, turn off the main power. (This step is needed only when the wireless LAN card being inserted into the projector's PC CARD slot)
3. Press the eject button. The PC card pops out a little. Grasp the edges of the PC card and pull it out.

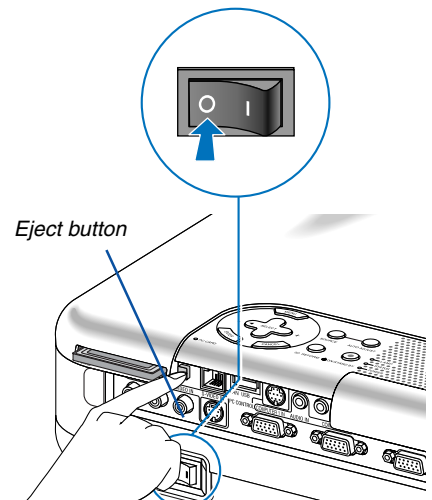

### **PC Card Type**

The PC Card slot accepts PCMCIA Type II only.

---

*NOTE: The projector does not support NTFS formatted flash memory card or USB memory device.*

*Be sure to use a flash memory card or USB memory device formatted with the FAT32, FAT16 or FAT file system.*

*To format your flash memory card or USB memory device in your computer, refer to the document or help file that comes with your Windows operating systems.*

---



### Connecting the Supplied Power Cable

Connect the supplied power cable to the projector.

First connect the supplied power cable's three-pin plug to the AC IN of the projector, and then connect the other plug of the supplied power cable in the wall outlet.

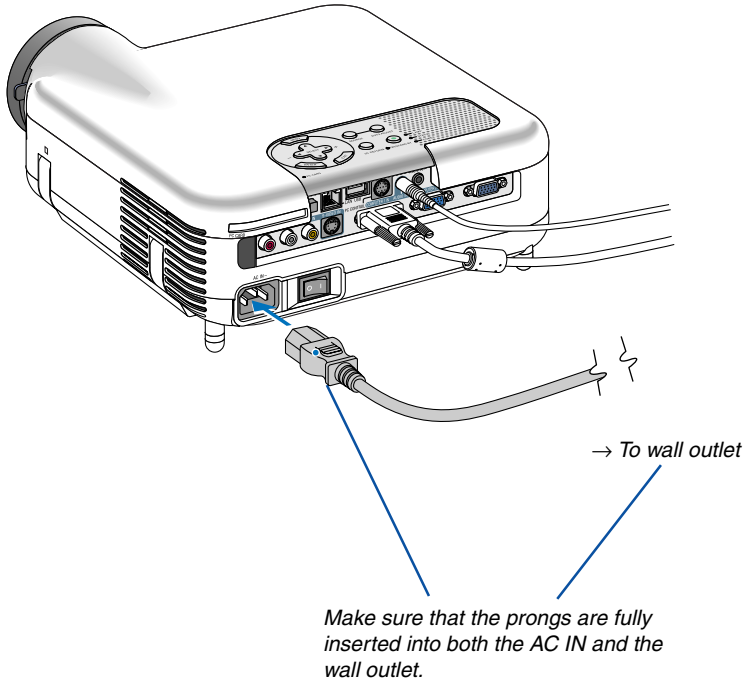

#### **CAUTION:**

**Do not unplug the power cable from the wall outlet under any one of the following circumstances. Doing so can cause damage to the projector or PC card:**

- While the projector's lamp is lighted.
- While the cooling fans are running. The cooling fans continue to work for 90 seconds after the projector is turned off.
- While the PC CARD Access Indicator lights. Doing so can damage your PC memory card.

# 3

## ***Projecting an Image***

### ***(Basic Operation)***

.....

① Turning on the Projector.....	28
② Selecting a Source .....	30
③ Adjusting the Picture Size and Position .....	31
④ Correcting Keystone Distortion .....	33
⑤ Optimizing an RGB Image Automatically .....	35
⑥ Turning Up or Down Volume .....	35
⑦ Using the Laser Pointer .....	36
⑧ Turning off the Projector.....	37
⑨ After Use .....	37

### 3. Projecting an Image (Basic Operation)

This section describes how to turn on the projector and to project a picture onto the screen.

## 1 Turning on the Projector

### NOTE:

- The projector has two power switches: a main power switch and a POWER (ON/STAND BY) button (POWER ON and OFF on the remote control).
- When plugging in or unplugging the supplied power cable, make sure that the main power switch is pushed to the off (O) position. Failure to do so may cause damage to the projector.
- The projector has a feature to prevent itself from being used by unauthorized individuals. To use this feature, register a keyword. See "Security" in "Setup" on page 48 for more details.

#### 1. To turn on the main power to the projector, press the Main Power switch to the on position (I).

- The POWER indicator will light orange.  
See the Power Indicator section on page 123 for more details.

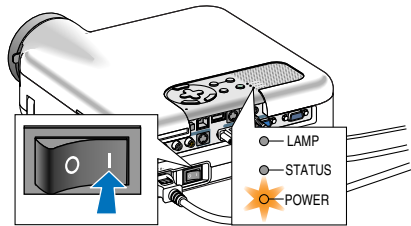

#### 2. Press the POWER (ON/STAND BY) button on the projector cabinet or POWER ON button on the remote control for a minimum of 2 seconds when the power indicator turns a steady green, and the projector is ready to use.

- After you turn on your projector, ensure that the computer or video source is turned on and that your lens cap is removed.

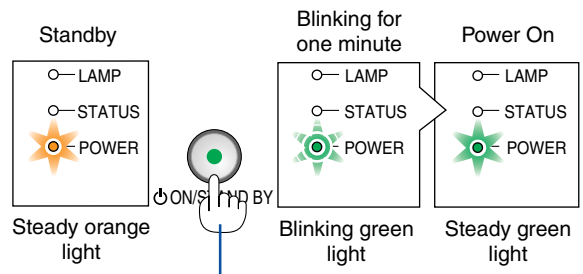
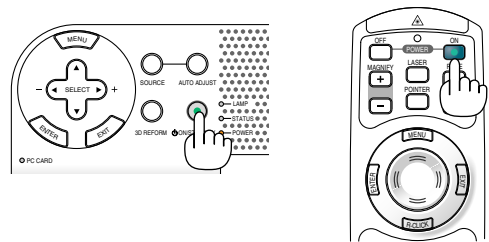

Press this button for a minimum of 2 seconds.

See page 123 for more details.

NOTE: When no signal is available, a blue, black or logo screen is displayed.

### 3. Projecting an Image (Basic Operation)

#### Note on Startup screen (Menu Language Select screen)

When you first turn on the projector, you will get the Startup menu. This menu gives you the opportunity to select one of the 21 menu languages.

To select a menu language, follow these steps:

1. Use the **SELECT** ▲ or ▼ button to select one of the 21 languages for the menu.

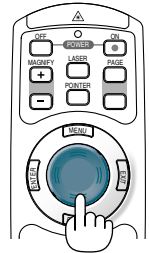
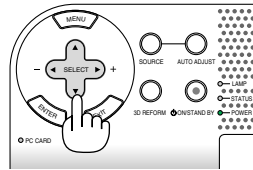
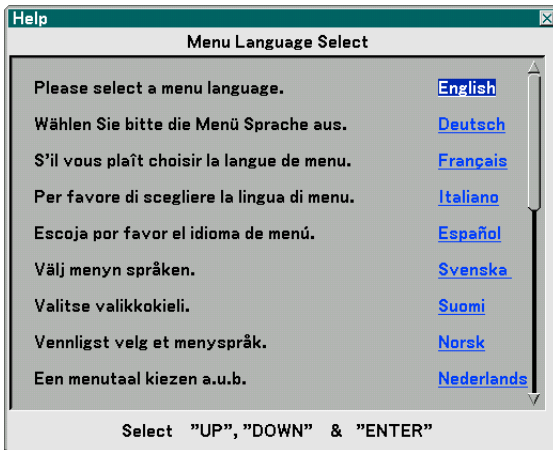

2. Press the **ENTER** button to execute the selection.

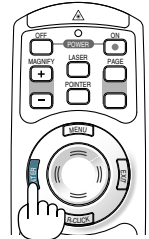
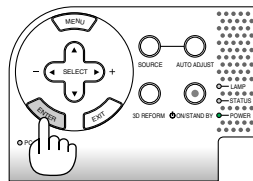

3. To close the menu, press the **EXIT** button.

*NOTE: Immediately after turning on the projector and displaying an image, you cannot turn off the projector for 60 seconds.*

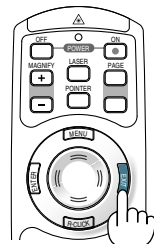
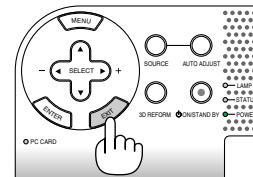

After this has been done, you can proceed to the menu operation.

If you want, you can select the menu language later. See "Language" on page 91.

*NOTE: Immediately after turning on the projector, screen flicker may occur. This is not a fault. Wait 3 to 5 minutes until the lamp lighting is stabilized.*

When the Lamp mode is set to Eco, the Lamp indicator will light green.

If one of the following things happens, the projector will not turn on.

- If the internal temperature of the projector is too high, the projector detects abnormal high temperature. In this condition the projector will not turn on to protect the internal system. If this happens, wait for the projector's internal components to cool down.
- When the lamp reaches its end of usable life, the projector will not turn on. If this happens, replace the lamp. See page 119.
- If the lamp fails to light, and if the STATUS indicator flashes on and off in a cycle of six times, wait a full minute and then turn on the power.

## ② Selecting a Source

### Selecting the computer or video source

#### Using the Remote Control

Press any one of the COMPUTER 1/2, VIDEO, S-VIDEO, VIEWER or LAN buttons.

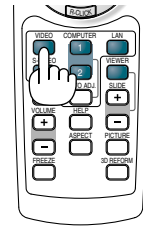

#### Selecting from Source List

Press and quickly release the SOURCE button on the projector cabinet to display the Source list. Each time the SOURCE button is pressed, the input source will change as follows: "Computer 1/2", "Video" (VCR or laser disc player), "S-Video", "Viewer" (slides on a PC card) or "LAN" (LAN port [RJ-45] or wireless LAN card). To display the selected source, press the ENTER button.

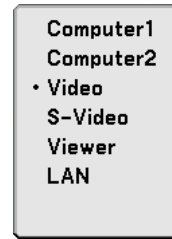
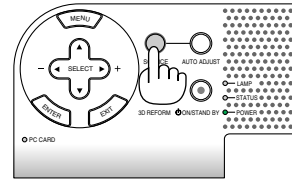

#### Detecting the Signal Automatically

Press and hold the SOURCE button for a minimum of 1 second, the projector will search for the next available input source. Each time you press and hold the SOURCE button for a minimum of 1 second, the input source will change as follows:

Computer1 → Computer2 → Video → S-Video → Viewer → Computer1 → ...

If no input signal is present, the input will be skipped. When the input source you wish to project is displayed, release the button.

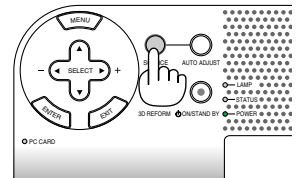

## ③ Adjusting the Picture Size and Position

Place your projector on a flat level surface and ensure that the projector is square to the screen.

Lift the front edge of the projector to center the image vertically.

If the projected image does not appear square to the screen, use the Keystone feature for proper adjustment. See pages 33 and 43.

Rotate the front of the projector right or left (to the right in this example) to center the image horizontally on the screen.

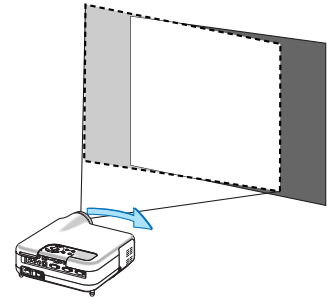
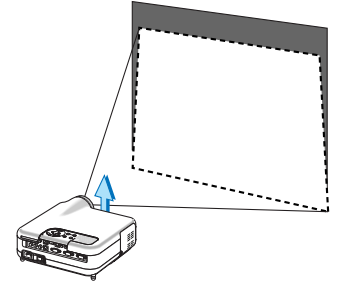

### Adjust the Tilt Foot

1. Lift the front edge of the projector.
2. Push up and hold the Adjustable Tilt Foot Button on the front of the projector to extend the adjustable tilt feet.
3. Lower the front of the projector to the desired height.
4. Release the Adjustable Tilt Foot Button to lock the Adjustable tilt foot.

There is approximately 7 degrees of up and down adjustment for the front of the projector.

Adjusting the height of a projected image or changing projection angle will run the Auto Keystone correction function to quickly correct the vertical distortion. The "Keystone" screen will be displayed.

For operating the "Keystone" screen, see "④ Correcting Keystone Distortion" on page 33.

*NOTE: Your "Keystone" correction data can be reset by pressing and holding the 3D REFORM button for a minimum of 2 seconds.*

The rear foot height can be changed. Rotate the rear foot to the desired height, but the vertical distance from the bottom to the desk or floor should be 1" (25mm) to make the projector horizontal on the flat surface.

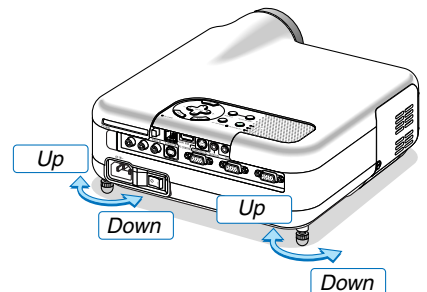
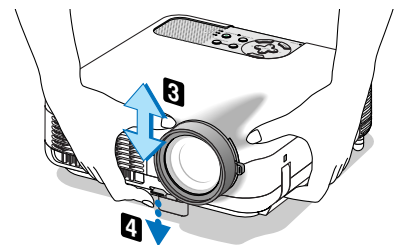
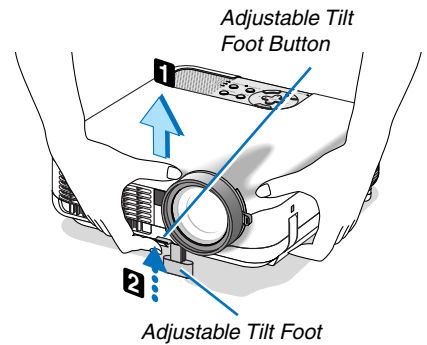

### CAUTION

Do not use the tilt-foot for purposes other than originally intended. Misuses such as gripping the tilt-foot or hanging on the wall can cause damage to the projector.

### 3. Projecting an Image (Basic Operation)

#### **Zoom**

Use the ZOOM lever to finely adjust the image size on the screen.

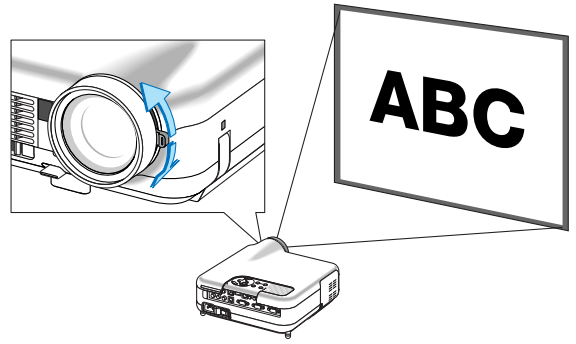

#### **Focus**

Use the FOCUS ring to obtain the best focus.

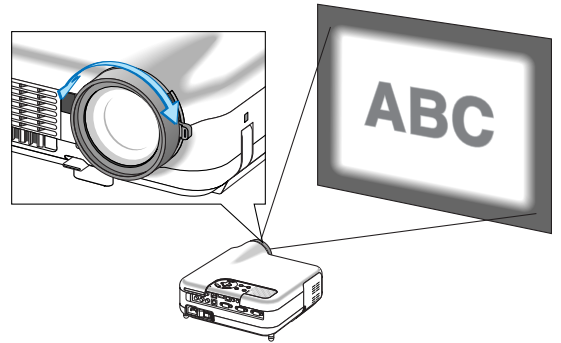

## 4 Correcting Keystone Distortion

### Auto Keystone Correction

The Auto Keystone correction feature will correct vertical distortion of a projected image on the screen. No special operation required. Just put the projector on a flat surface.



### Manual Keystone Correction

You can also correct keystone distortion manually. To do so:

**1. Extend the Adjustable Tilt Foot to adjust the height of a projected image. See page 31.**

The Keystone screen will be displayed on the screen.

- If the Keystone screen disappears, press the 3D REFORM button once to display the Keystone screen again.

**2. Align the left (or right) side of the screen with the left (or right) side of the projected image.**

- Use the shorter side of the projected image as the base.
- In the right example, use the left side as the base.

*NOTE: When "Manual" is selected in "Keystone" from the menu, project an image adjusting projector position so that the screen is smaller than the area of the projected image. See page 90 for selecting "Manual" in "Keystone".*

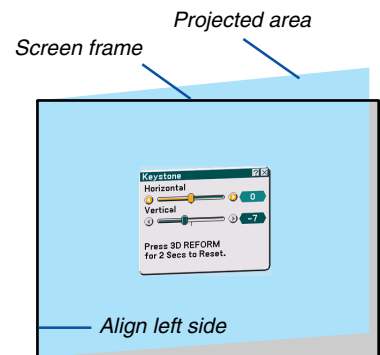
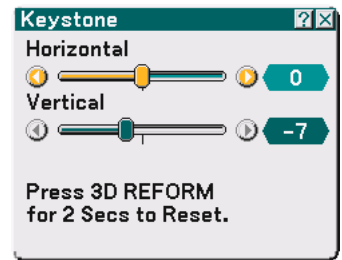

**3. Use the SELECT ◀ or ▶ button to adjust "Horizontal".**

Perform the keystone correction.

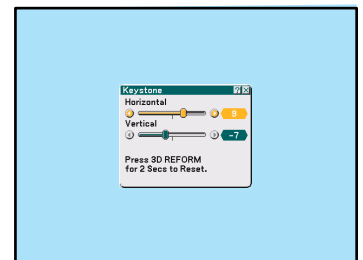

**4. If the right and left sides of the projected image are not parallel to each other, use the SELECT ▼ button to select "Vertical" and use the SELECT ◀▶ button.**

Fine adjust so that both sides are parallel to each other.

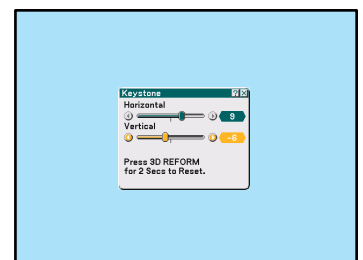



### 3. Projecting an Image (Basic Operation)

5. Repeat steps 3 and 4 to correct keystone distortion.

6. After completing Keystone correction, press the ENTER button.

The Keystone screen will disappear.

- To perform Keystone correction again, press the 3D REFORM button to display the Keystone screen and repeat above steps 1 to 6.

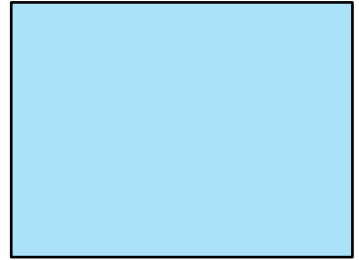

---

**NOTE:**

- Turning on the projector will reset the previous correction setting values and correct distortion anew if the projection angle is changed from the last use.  
If the projection angle is the same as in the last use, the previous correction setting values are retained in the memory.  
To use the previous correction setting values after changing projection angle, select "Manual" in "Keystone" from the menu. See page 90.
  - To reset the 3D Reform correction setting values, press and hold the 3D REFORM button for a minimum of 2 seconds.
  - Each time the 3D REFORM button is pressed, the item will change as follows: Keystone → Cornerstone → None → Keystone → ...  
For information on "Cornerstone", see "Correcting Horizontal and Vertical Keystone Distortion (Cornerstone) on page 43.
-

## 5 Optimizing an RGB Image Automatically

### Adjusting the Image Using Auto Adjust

Optimizing an RGB image automatically.

Press the Auto Adjust button to optimize an RGB image automatically.

[Poor picture]

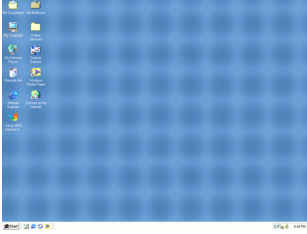

[Normal picture]

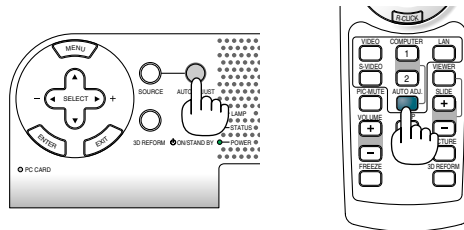
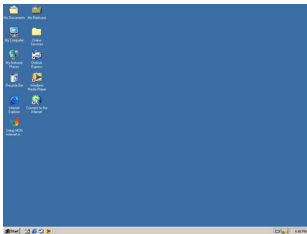

Press the Auto Adjust button to fine-tune the computer image or to remove any vertical banding that might appear and to reduce video noise, dot interference or cross talk (this is evident when part of your image appears to be shimmering). This function adjusts the clock frequencies that eliminate the horizontal banding in the image. This function also adjusts the clock phase to reduce video noise, dot interference or cross talk.

This adjustment may be necessary when you connect your computer for the first time.

#### NOTE:

- Some signals may not be displayed correctly or take time.
- The Auto Adjust function does not work for component or video signals.
- If the Auto Adjust operation cannot optimize the RGB signal, try to adjust Clock and Phase manually. See page 86.

## 6 Turning Up or Down Volume

Sound level from the speaker and the AUDIO OUT jack (Stereo mini) on the projector can be adjusted.

NOTE: When no menus appear, the SELECT ◀▶ buttons on the projector cabinet work as a volume control.

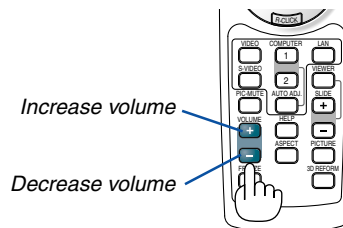

## 7 Using the Laser Pointer

You can use the laser to draw your audience's attention to a red dot that you can place on any object.



#### CAUTION:

- Do not look into the laser pointer while it is on.
- Do not point the laser beam at a person.
- Do not allow children to use the laser pointer.

Press and hold the LASER button to activate the laser pointer.

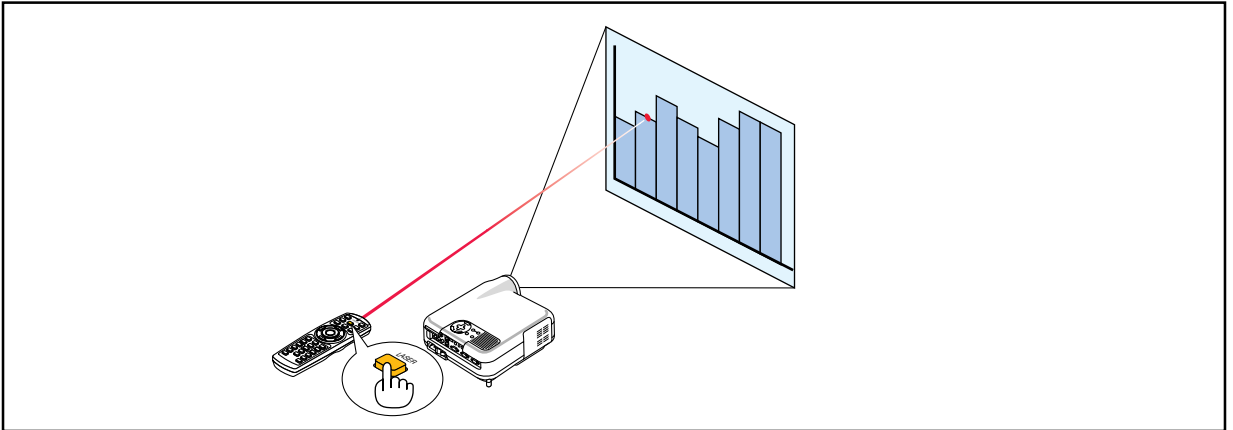

To disable the laser pointer, set the function switch to "Off".

Decide whether to enable or disable the laser, then set the switch as necessary using the tip of a thin ball-point pen. On this model, the other selector switch is not used.

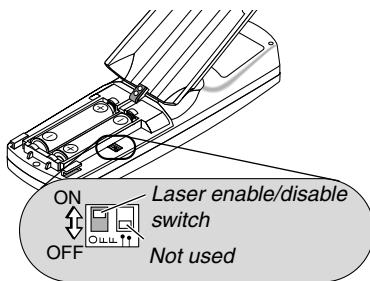

On: Enabled (the laser lights when the LASER button is pressed) [Factory default]

Off: Disabled (the laser does not light even when the LASER button is pressed)

Disable the laser when using in an environment in which the unit is accessible to children.

## 8 Turning off the Projector

To turn off the projector:

1. Press the **POWER (ON/STAND BY)** button on the projector cabinet or the **POWER OFF** button on the remote control. The "Power Off / Are you sure?" message will appear.

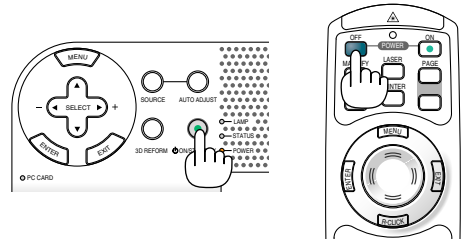
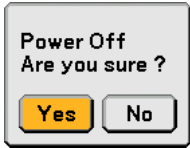

2. Press the **ENTER** button or the **POWER (ON/STANDBY)** or the **POWER OFF** button again.

The power indicator will glow orange. After the projector turns off, the cooling fans keep operating for 90 seconds (Cooling-off time).

*NOTE: Immediately after turning on the projector and displaying an image, you cannot turn off the projector for 60 seconds.*

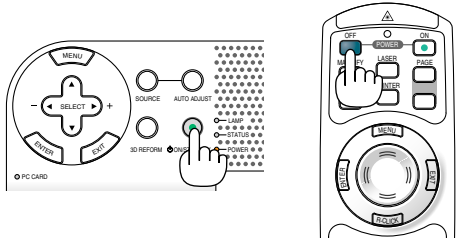

3. Turn off the **Main Power switch**. The power indicator will go out.

### CAUTION

**Do not unplug the power cable from the wall outlet or do not turn off the main power under any one of the following circumstances.**

**Doing so can cause damage to the projector or PC card:**

- While the projector lamp is lighted.
- While the cooling fans are running. (The cooling fans continue to work for 90 seconds after the projector is turned off).
- While the PC CARD Access Indicator lights. Doing so can damage your PC memory card.

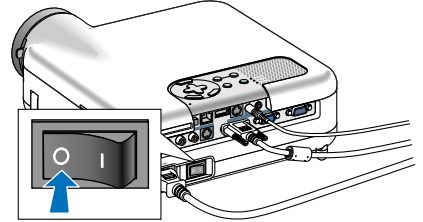

## 9 After Use

**Preparation:** Make sure that the main power is turned off.

1. **Unplug the power cable.**
2. **Disconnect any other cables.**
3. **Retract adjustable tilt feet if extended.**
4. **Cover the lens with the lens cap.**
5. **Put the projector and its accessories in the supplied soft case.**

*NOTE: Before putting the projector in the soft case, be sure to retract the feet. Failure to do so may cause the damage to the projector.*

# 4

## ***Convenient Features***

.....

①	Turning Off the Image and Sound .....	39
②	Freezing a Picture .....	39
③	Using the Pointer .....	39
④	Enlarging and Moving a Picture .....	40
⑤	Getting Integrated Help .....	40
⑥	Using a USB Mouse .....	41
⑦	Using Remote Mouse Receiver .....	42
⑧	Correcting Horizontal and Vertical Keystone Distortion (Cornerstone) .....	43
⑨	Making Freehand Drawings on a Projected Image (ChalkBoard) .....	46
⑩	Storing Images Displayed on the Projector on the PC card or USB Memory (Capture) .....	47
⑪	Preventing Unauthorized Use of the Projector .....	48
⑫	Using a USB Memory Device or USB Memory Card Reader .....	53
⑬	Operation Using an HTTP Browser .....	54
⑭	Using the Projector to Operate a Computer Connected on a Network (Desktop Control Utility 1.0) .....	57

### 1 Turning Off the Image and Sound

Press the PIC-MUTE button to turn off the image and sound for a short period of time. Press again to restore the image and sound.

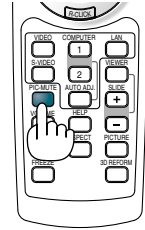

### 2 Freezing a Picture

Press the FREEZE button to freeze a picture. Press again to resume motion.

*NOTE: Pressing the MENU button will display the Capture menu that allows you to capture a frozen image. See page 47 for more information.*

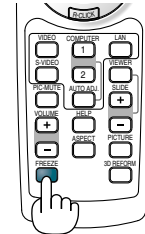

### 3 Using the Pointer

You can use one of nine pointers to draw your audience's attention to the portion of a projected image you want.

*NOTE: You can select one pointer from the menu. See page 111.*

Press the POINTER button to display the pointer.

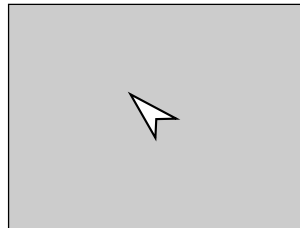

Press the Pointer button to display the pointer.

Use the SELECT button to move the pointer. Press the POINTER button again. The pointer will disappear.

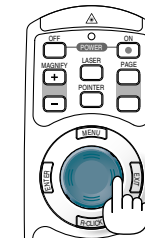
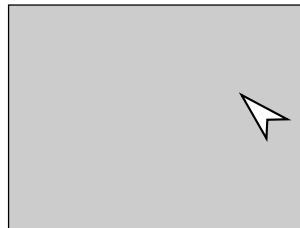

Use the Select button to move the pointer.

## 4 Enlarging and Moving a Picture

You can enlarge the area you want up to 400 percent.

To do so:

1. Press the **POINTER** button to display the pointer.

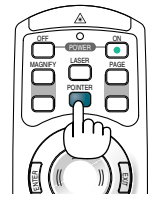
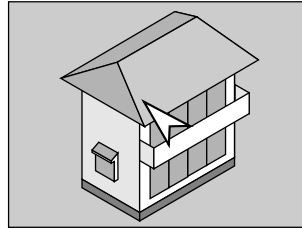

2. Move the pointer to the area you want to enlarge.

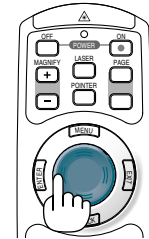
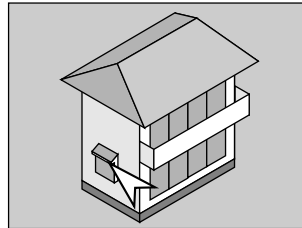

3. Enlarge the selected area.

When the **MAGNIFY (+)** button is pressed, the image is magnified and the magnify icon will be displayed. To magnify the selected area, use the **SELECT ▲▼◀▶** button to move the magnify icon and press the **MAGNIFY (+)** button.

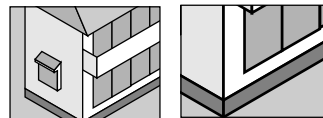
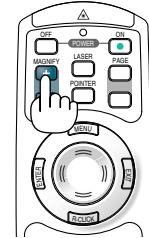
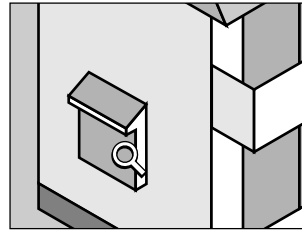

4. Return the image to the original size.

Press the **MAGNIFY (-)** button until the magnify icon changes to the pointer.

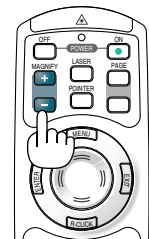

## 5 Getting Integrated Help

You get the contents about Help in English, German and Japanese.

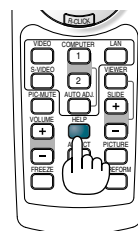

Display Help

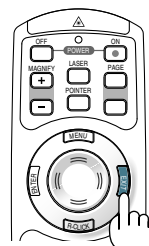

Exit Help

### 6 Using a USB Mouse

Using a USB mouse gives you a smooth operation. A commercially available USB mouse can be used.

*NOTE: There may be some brands of a USB mouse that the projector does not support.*

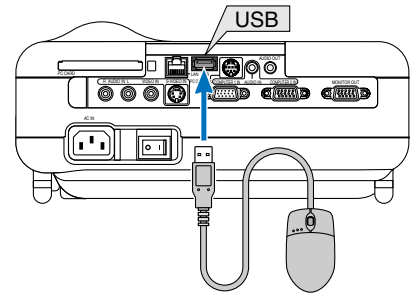

#### Operate the Menus using the USB mouse

##### Mouse Cursor

When connecting a USB mouse to the projector, you get a mouse cursor on the screen. Unless you use your USB mouse within 10 seconds, the mouse cursor disappears.

*NOTE: You can change the shape of the mouse cursor. To do so, select the menu → Setup → Tools → Mouse → Mouse Pointer*

##### Menu Display

Clicking with the right mouse button displays the menu. To close the menu, click anywhere in the background.

##### Adjusting and Setting Display

You can select a menu item and click with the left mouse button to make adjustments and settings.

##### Using the middle button on the mouse

The projector supports the middle button on your mouse.

With the middle button you can do the following:

- You can use a scroll bar in the menu or the help.
- You can click the middle button to display or hide the Chalkboard toolbar.

##### Example:

Click (or press and hold) the left mouse button on the ◀ or ▶ to adjust the brightness. Or click and drag the left mouse button on the slide bar horizontally to adjust it.

To save the adjustments, click . The display is closed.

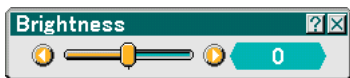

- Click  with the left mouse button to display a description of the selected menu item.
- Click and drag the title bar with the left mouse button to move the adjustment or setting dialog box.



### 7 Using Remote Mouse Receiver

The remote mouse receiver enables you to operate your computer's mouse functions from the remote control. It is a great convenience for your computer-generated presentations.

#### Connecting the remote mouse receiver to your computer

If you wish to use the remote mouse function, connect the mouse receiver and computer. The mouse receiver can be connected directly to the computer's USB port (type A).

---

*NOTE: Depending on the type of connection or OS installed on your computer, you may have to restart your computer or change your computer settings.*

---

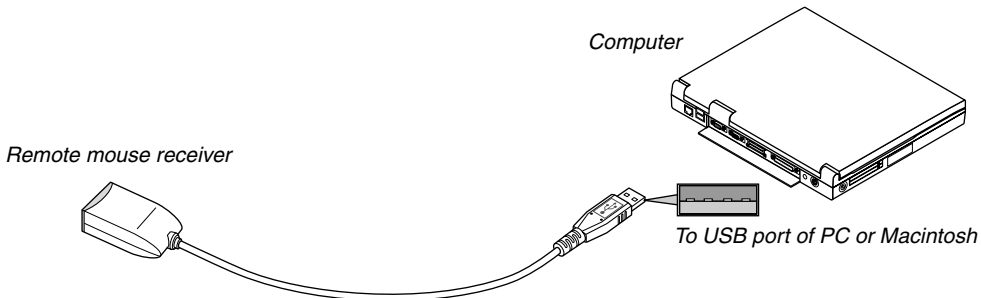

#### When operating a computer via the remote mouse receiver

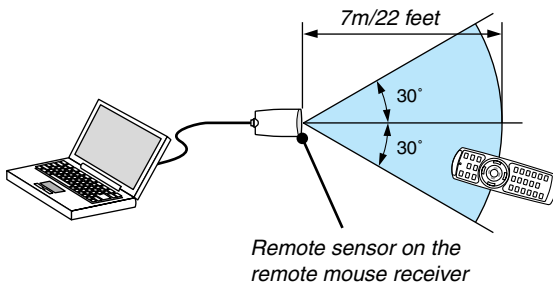

#### When connecting using the USB port

For PC, the mouse receiver can only be used with a Windows 98/Me/XP\* or Windows 2000 operating system.

---

*\* NOTE: In Windows XP, if the mouse cursor will not move correctly, do the following:*

*Clear the Enhance pointer precision check box underneath the mouse speed slider in the Mouse Properties dialog box [Pointer Options tab].*

---

*NOTE: Wait at least 5 seconds after disconnecting the mouse receiver before reconnecting it and vice versa. The computer may not identify the mouse receiver if it is repeatedly connected and disconnected in rapid intervals.*

---

#### Operating your computer's mouse from the remote control

You can operate your computer's mouse from the remote control.

PAGE UP/DOWN Button: scrolls the viewing area of the window or to move to the previous or next slide in PowerPoint on your computer.

Select Button: moves the mouse cursor on your computer.

MOUSE L-CLICK Button: works as the mouse left button.

MOUSE R-CLICK Button: works as the mouse right button.

---

*NOTE: You can change the Pointer speed on the Mouse Properties dialog box on the Windows. For more information, see the user documentation or online help supplied with your computer.*

---

## ⑧ Correcting Horizontal and Vertical Keystone Distortion (Cornerstone)

Use the 3D Reform feature to correct keystone (trapezoidal) distortion to make the top or bottom and the left or right side of the screen longer or shorter so that the projected image is rectangular.

### Cornerstone

1. **Press and hold the 3D REFORM button for a minimum of 2 seconds to reset current adjustments.**  
Current adjustments for “Keystone” or “Cornerstone” will be cleared.
2. **Project an image so that the screen is smaller than the area of the raster.**
3. **Pick up any one of the corners and align the corner of the image with a corner of the screen.**

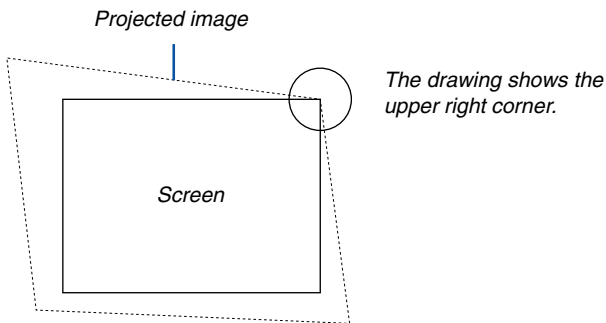

4. **Press the 3D REFORM button on the remote control twice.**  
The Cornerstone adjustment screen is displayed.

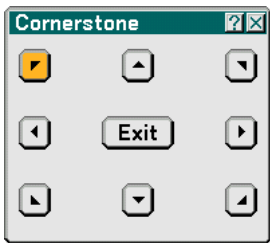

5. **Use the SELECT ▲▼◀▶ button to select one icon which points in the direction you wish to move the projected image frame.**
6. **Press the ENTER button.**
7. **Use the SELECT ▲▼◀▶ button to move the projected image frame as shown on the example.**

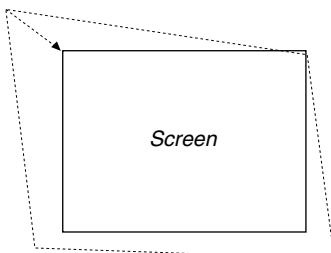

**8. Press the ENTER button.**

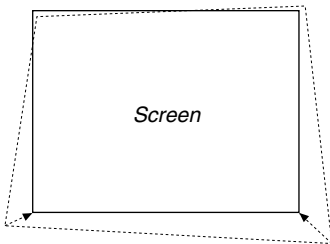

**9. Use the SELECT ▲▼◀▶ button to select another icon which points in the direction.**

On the Cornerstone adjustment screen, select "Exit" or press the EXIT button on the remote control.

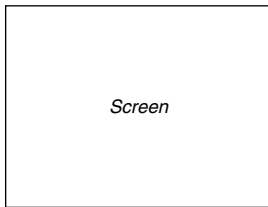

The confirmation screen is displayed.



**10. Press the SELECT ◀ or ▶ button to highlight the [OK] and press the ENTER button.**

This completes the keystone correction.

Selecting "Cancel" will return to the adjustment screen without saving changes (Step 3).

Selecting "Reset" will return to the factory default.

Selecting "Undo" will exit without saving changes.

---

*NOTE: To reset the 3D Reform correction setting values, press and hold the 3D REFORM button for a minimum of 2 seconds.*

---

*NOTE: During 3D Reform adjustment, "Aspect Ratio" and "Screen" may not be available. Should this happen, first reset the 3D Reform data and then do each setting. Second repeat the 3D Reform adjustment. Changing Aspect Ratio and/or Screen setting can limit 3D Reform in its adjustable range.*

---

The adjustable ranges for 3D Reform are as follows:

	Horizontal	Vertical
Cornerstone	Max. +/- 35° approx.	Max. +/- 40° approx.
Keystone	LT265: Max. +/- 35° approx. LT245: Max. +/- 30° approx.	

\* The following are conditions under which the maximum angle is achieved:

- Image is projected in Wide (Zoom lever)
- Resolution is XGA  
Higher resolution than XGA narrows the adjustable range.
- Menu items should be set as follows:  
Aspect Ratio ..... 4:3  
Screen Type ..... 4:3
- Horizontal and Vertical are adjusted separately.  
A combination of both adjustments narrows the adjustable range.
- When "4:3 Fill" is selected in Aspect Ratio, "Cornerstone" and "Horizontal Keystone" are not available.

---

**NOTE:**

- If the Cornerstone screen is unavailable (grayed), press and hold the 3D REFORM button for a minimum of 2 seconds to reset the current correction data. The Cornerstone function becomes available.
  - Turning on the projector will reset the previous correction setting values and correct distortion anew if the projection angle is changed from the last use.  
If the projection angle is the same as in the last use, the previous correction setting values are retained in the memory.  
To use the previous correction setting values after changing projection angle, select "Manual" in "Keystone" from the menu. See page 90.
- 

**NOTE:** The 3D Reform feature can cause an image to be slightly blurred because the correction is made electronically.

---



## 9 Making Freehand Drawings on a Projected Image (ChalkBoard)

The ChalkBoard feature allows you to write and draw messages on a projected image.

*NOTE: The ChalkBoard feature is available only when a USB mouse is used.*

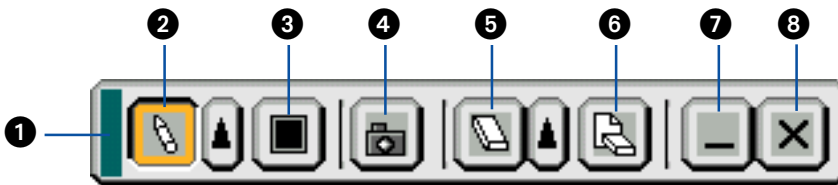
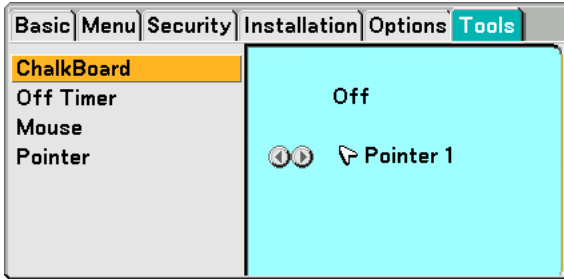
To display the ChalkBoard tool bar, click the middle button on your mouse or select "ChalkBoard" from the menu. The tool bar contains the following icons.



- ① Drag ..... Drags to move the tool bar.
- ② Pen ..... Left-click and drag to draw. Left-click  or right-click the pen icon to display the pen palette containing four lines of different thickness from which you can select a line you prefer by left-clicking.
- ③ Color ..... Selects a color. Left-click to display the color palette from which you can select a color you prefer by left-clicking.
- ④ Capture ..... Left-click to capture a drawing on the ChalkBoard screen and save it to your PC-card inserted into the PC card slot of the projector.
- ⑤ Eraser ..... Left-click and drag to erase part of a drawing. Left-click  or right-click the eraser icon to display the eraser palette containing four erasers of different thickness from which you can select an eraser you prefer by left-clicking.
- ⑥ Clear ..... Left-click to clear the drawing completely from the ChalkBoard screen.
- ⑦ Hide ..... Hides the tool bar by left-clicking. Right-clicking anywhere on the screen displays the ChalkBoard tool bar again.
- ⑧ Exit ..... Clears the complete drawing and exits the ChalkBoard.

**NOTE:**

- The menu is not available while you display the ChalkBoard screen.
- Selecting another source or switching slides in the Viewer clears a drawing completely.

## ⑩ Storing Images Displayed on the Projector on the PC card or USB memory (Capture)

The Capture features allows you to capture an image from a source that is currently being displayed. The image is saved as JPEG in the PC card or USB memory.

---

**NOTE:**

- Unless a PC card or USB memory is inserted into the PC Card slot or USB port of the projector, the Capture feature is not available.
  - The "Card Error" display means that the free space of the PC card or USB memory is insufficient for saving images. Make more space available on the card by erasing unwanted images with your PC. The number of images that can be captured depends on the size of the PC card.
  - Be sure not to turn off the power or remove the PC card or USB memory while capturing an image. Doing so could cause a loss of the data in the PC card or USB memory or damage to the card itself.
- 

**Preparations:**

Insert the PC card into the PC card slot or USB memory into USB port of the projector.

Insert the PC card so that the end with the insertion direction arrow on the top goes in first.

\* Press the eject button to eject the card.

- 1. Project the image you wish to store on the projector.**
- 2. Press the FREEZE button on the remote control.**
- 3. Press the MENU button to display the Capture menu.**

Capture ..... Captures an image and save it as a JPEG file in a PC card or USB memory.

Drive ..... Select the PC Card or USB memory. You can capture an image and save it to your PC card or USB memory.

Exit ..... Exits the Capture function. Another option to exit the Capture function is to press the MENU or EXIT button on the remote control or projector cabinet.

---

**NOTE:**

*Captured images with higher resolution than the projector's native resolution cannot be displayed correctly.*

- *File size of the captured image varies depending on the resolution of an input signal.*
  - *An hourglass indicating that an image is being captured appears on the projector's display. Do not eject the PC card or turn off the projector's power while this icon is displayed. Doing so will damage the PC card data. If the PC card data is damaged, use a computer to repair the data.*
-

## Ⓜ Preventing Unauthorized Use of the Projector

Assigning a keyword prevents the projector from being used by unauthorized individuals.

### Assigning a Keyword for the first time

1. Press the **MENU** button.

*The menu will be displayed.*



2. Press the **SELECT** ► button to highlight the **Setup** submenu and press the **ENTER** button.

*The page tab “Basic” will be highlighted.*

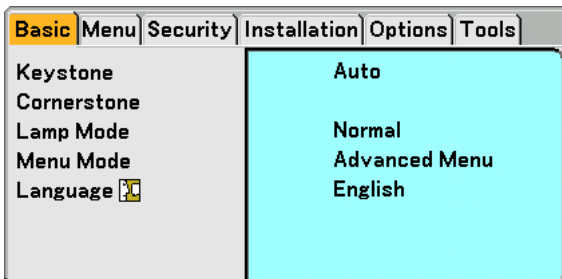

3. Press the **SELECT** ► button twice to highlight the page tab “Security”.

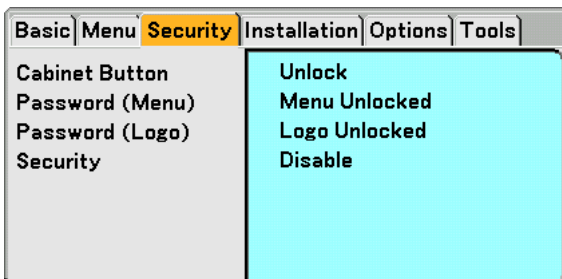

4. Press the **SELECT** ▼ button four times to highlight “Security”.

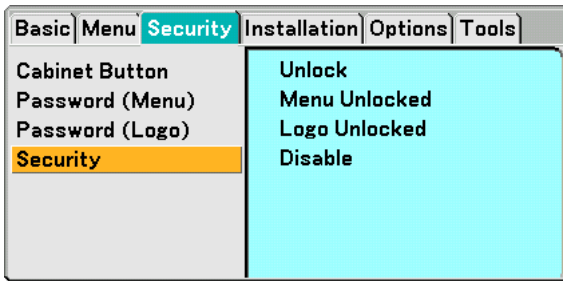

5. Press the **ENTER** button to display the Security screen.

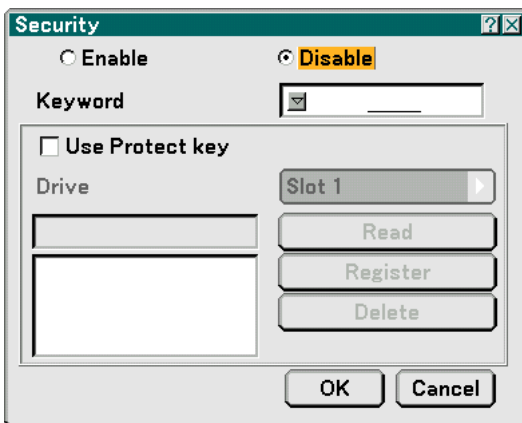

6. Press the **ENTER** ▼ button once to highlight the Keyword entry box and press the **ENTER** button. The Software keyboard will be displayed.

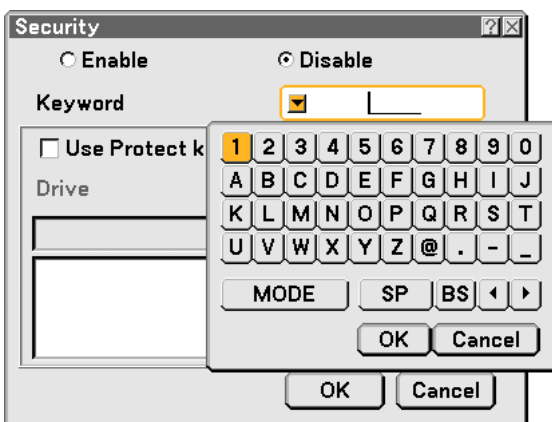



### 7. Enter an alphanumeric keyword using the Software keyboard

For example, to enter “1234”, follow the steps 7-1 to 7-4 below.

**NOTE:**

- Please make a note of your keyword.
- Do not use spaces (SP) in your keyword.

7-1. Highlight the number “1” and press the ENTER button.

The asterisk “\*” will be displayed in the Keyword entry box.

7-2. Press the SELECT ► button once to highlight “2” and press the ENTER button.

The asterisk “\*\*” will be displayed in the Keyword entry box.

7-3. For “3” and “4”, use the same procedure as step 7-2.

The asterisk “\*\*\*\*” will be displayed in the Keyword entry box.

7-4. Press the SELECT ▼ button to highlight “OK” and press the ENTER button.

The Software keyboard will disappear.

### 8. Press the SELECT ▲ button once to highlight “Disable” and press the SELECT ◀ button to highlight “Enable”.

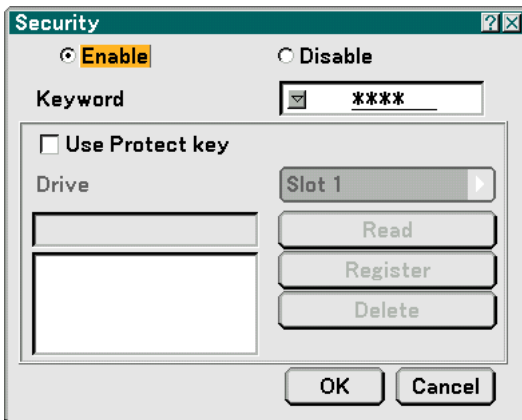

### 9. Press the SELECT ▼ button to highlight “OK” and press the ENTER button.

The confirmation screen will be displayed.

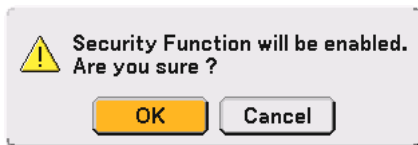

### 10. Press the ENTER button.

The Security Function is now enabled.

**NOTE:** A PC card can be used as a protect key. You can skip the keyword entry by inserting a registered PC card when turning on the projector. See page 96.

### Checking If Security is enabled

Turn off the projector and turn it back on to check if the Security function is enabled.

**1. Press the POWER (ON/STANDBY) button.**

The "Power Off / Are you sure?" message will appear.

Press the ENTER button or the POWER (ON/STANDBY) or the POWER OFF button again.

The lamp lights off and the POWER indicator flashes orange. Please wait until the POWER indicator changes from flashing to steady light.

**2. When the POWER indicator lights steady orange, push the Main POWER switch to the off position (O).**

The projector will turn off.

**3. Push the Main POWER switch to the on position (I).**

The POWER indicator lights orange. The projector is in standby condition.

**4. Press and hold the POWER (ON/STANDBY) button for a minimum of two seconds.**

The projector will turn on. The "Projector is locked! Enter your keyword." message will be displayed at the bottom of the screen.

**5. Press the MENU button.**

The Keyword entry screen will be displayed

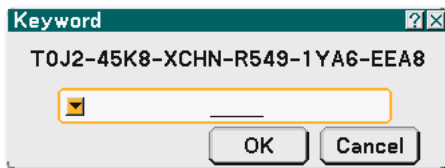

**6. Press the ENTER button.**

The Software keyboard will be displayed.

**7. Use the same procedures as steps 1 to 7 described in the "Assigning a Keyword for the first time" section to enter "1234".**

Each time one number is entered, an "\*" (asterisk) will appear. Keyword appears as asterisks so the real keyword is hidden.

**8. After entering your keyword, highlight "OK" and press the ENTER button.**

The Software keyboard will disappear. This will allow you to operate the projector.

### Disabling the Security

**1. Press the MENU button.**

The on-screen menu will be displayed.

---

*NOTE: Immediately after the projector has been turned on and the "Projector is locked! Enter your keyword." message is displayed at the bottom of the screen, pressing the MENU button will display the Keyword entry screen. At this time, pressing the MENU button will display the on-screen menu.*

---

**2. Press the SELECT ► button to highlight "Setup" and press the ENTER button.**

The page tab "Basic" will be highlighted.

**3. Press the SELECT ► button twice to highlight the page tab "Security".**

**4. Press the SELECT ▼ button four times to highlight "Security" and press the ENTER button.**

The Keyword entry screen will be displayed

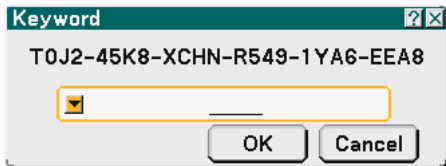

**5. Press the ENTER button.**

The Software keyboard will be displayed.

**6. Use the same procedures as steps 1 to 7 described in the "Assigning a Keyword for the first time" section to enter "1234".**

Each time one number is entered, an "\*" (asterisk) will appear. Keyword appears as asterisks so the real keyword is hidden.

**7. After entering your keyword, highlight "OK" and press the ENTER button.**

The Software keyboard will disappear. The Security screen will be displayed.

**8. Highlight "Enable" and press the SELECT ► button to highlight "Disable".**

**9. Press the SELECT ▼ button to highlight "OK" and press the ENTER button.**

The Security Function is now disabled.

---

*NOTE: Do not forget your keyword. However, if you forget your keyword, NEC or your dealer will provide you with your Release Code.*

---

## 12 Using a USB Memory Device or USB Memory Card Reader

The projector is compatible with either a USB memory device or USB memory card reader which supports the viewer and security features.

- To use a USB memory device or USB memory card reader, connect the device to the USB port (type A).
- Select one of the drive icons for your USB memory in a pane on the left side of the Viewer window.
- To use a USB memory device as a Protect key for Security function, select one from the Drive icons in the Security setting screen. See page 95.

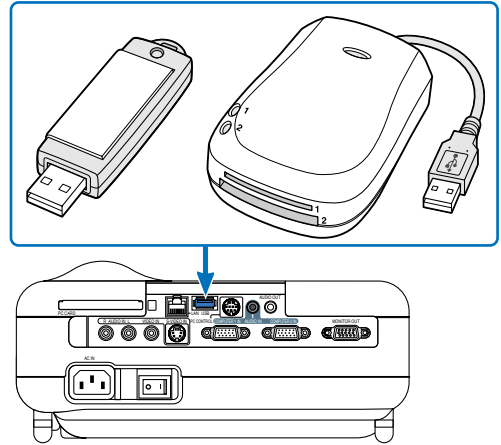

**NOTE:**

- Some USB memory devices (brands) or USB memory card readers may not work.
- The projector does not support NTFS formatted flash memory card or USB memory device.  
Be sure to use a flash memory card or USB memory device formatted with the FAT32, FAT16 or FAT file system.  
To format your flash memory card or USB memory device in your computer, refer to the document or help file that comes with your Windows.
- You cannot use a USB memory device and a USB memory card reader when connecting a USB mouse to the projector.
- Do not do the following while the USB memory device or USB memory card reader's access indicator is lit or flashing (while data is being accessed.) Doing so can damage your USB memory device or USB memory card reader in the reader. Back up your data in case it will need to be restored.
  - \* Pulling out the USB memory device or USB memory card reader from the USB port of the projector.
  - \* Pulling out the memory card from the USB memory card reader
  - \* Turning off the main power switch or unplugging the power cable.
- The drive for "USB 1-4" is displayed only when the USB memory device or USB memory card reader is connected to the projector. The drive for "USB 1-4" may be displayed differently from the one in the USB memory card reader.
- Some USB memory devices (brands) or USB memory card readers cannot be used as Protect key for the projector's Security function.

**CAUTION:** Do not insert a USB memory device or USB memory card reader into the LAN port (RJ-45). Doing so can cause damage to the LAN port (RJ-45).

### 13 Operation Using an HTTP Browser

#### Overview

The use of HTTP server functions will allow control of the projector from a web browser without the installation of special software. Please be sure to use "Microsoft Internet Explorer 4.x" or a higher version for the web browser. (This device uses "JavaScript" and "Cookies" and the browser should be set to accept these functions. The setting method will vary depending on the version of browser. Please refer to the help files and the other information provided in your software.)

---

#### NOTE:

\* The display's or button's response can be slowed down or operation may not be accepted depending the settings of your network. Should this happen, consult your network administrator.

\* The projector may not respond if its buttons are repeatedly pressed in rapid intervals. Should this happen, wait a moment and repeat. If you still can't get any response, turn off and back on the projector.

Access is gained to the HTTP server functions by specifying

`http:// <the projector's IP address> /index.html`  
in the entry column of the URL.

---

#### CAUTION:

Do not use the HTTP Server functions and PC Control Utility 3.0 included on the supplied CD-ROM. Using both at the same time may result in a connection failure or slow response.

#### Preparation Before Use

Make network connections and set up the projector and confirm that it is complete before engaging in browser operations. (See "Setting LAN Mode" on page 99.)

Operation with a browser that uses a proxy server may not be possible depending on the type of proxy server and the setting method. Although the type of proxy server will be a factor, it is possible that items that have actually been set will not be displayed depending on the effectiveness of the cache, and the contents set from the browser may not be reflected in operation. It is recommended that a proxy server not be used unless it is unavoidable.

#### Handling of the Address for Operation via a Browser

Regarding the actual address that is entered for the address or entered to the URL column when operation of the projector is via a browser, the host name can be used as it is when the host name corresponding to the IP address of the projector has been registered to the domain name server by a network administrator, or the host name corresponding to the IP address of the projector has been set in the "HOSTS" file of the computer being used.

Example 1: When the host name of the projector has been set to "pj.nec.co.jp",  
`http://pj.nec.co.jp/index.html`  
is specified for the address or the entry column of the URL.

Example 2: When the IP address of the projector is "192.168.73.1", access is gained to the  
HTTP server functions by specifying  
`http://192.168.73.1/index.html`  
for the address or the entry column of the URL.

Structure of the HTTP Server

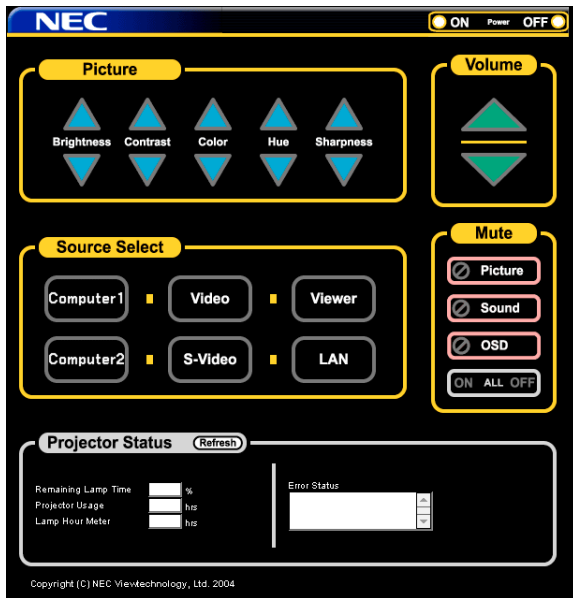

Power: This controls the power of the projector.

- On ..... Power is switched on.
- Off ..... Power is switched off.

Volume: This controls the volume of the projector.

- ▲ ..... Increases the volume adjustment value.
- ▼ ..... Decreases the volume adjustment value.

Mute: This controls the mute function of the projector.

- Picture On ..... Mutes the video.
- Picture Off ..... Cancels the video muting.
- Sound On ..... Mutes the audio.
- Sound Off ..... Cancels the audio muting.
- OSD On ..... Mutes the on-screen display.
- OSD Off ..... Cancels the muting of the on-screen display.
- All On ..... Mutes each of the video, audio, and on-screen display functions.
- All Off ..... Cancels the muting of each of the video, audio, and on-screen display functions.

Picture: Controls the video adjustment of the projector.

- Brightness ▲ ... Increases the brightness adjustment value.
- Brightness ▼ ... Decreases the brightness adjustment value.
- Contrast ▲ ..... Increases the contrast adjustment value.
- Contrast ▼ ..... Decreases the contrast adjustment value.
- Color ▲ ..... Increases the color adjustment value.
- Color ▼ ..... Decreases the color adjustment value.
- Hue ▲ ..... Increases the hue adjustment value.
- Hue ▼ ..... Decreases the hue adjustment value.
- Sharpness ▲ ... Increases the sharpness adjustment value.
- Sharpness ▼ ... Decreases the sharpness adjustment value.

- The functions that can be controlled will vary depending on the signal being input to the projector.

Source Select: This switches the input connector of the projector.

- Computer1 ..... Switches to the COMPUTER 1 IN connector.
- Computer2 ..... Switches to the COMPUTER 2 IN connector.
- Video ..... Switches to the VIDEO IN connector.
- S-Video ..... Switches to the S-VIDEO IN connector.
- Viewer ..... Switches to the Viewer.
- LAN ..... Switches to a LAN signal.

Projector Status: This displays the condition of the projector.

- Remaining Lamp Time ... Displays the remaining life of the lamp as a percentage.
- Lamp Hour Meter ..... Displays how many hours the lamp has been used.
- Projector Usage ..... Displays how many hours the projector has been used.
- Error Status ..... Displays the status of errors occurring within the projector.
- Refresh ..... Updates the display of the following conditions.

### 14 Using the Projector to Operate a Computer Connected on a Network (Desktop Control Utility 1.0)

When Desktop Control Utility 1.0 on the included User Supportware 2 CD-ROM is installed on the computer, that computer can be operated using the projector over a network.

For example, say you have a PowerPoint file on a computer in your office that you want to use for a presentation at a meeting. If the computer in the office is connected by LAN to the projector in the meeting room, the projector can be operated to project the image of the desktop of the computer (Windows 2000 or XP) in the office and display the PowerPoint file during the meeting. This eliminates the need for taking the computer from the office to the meeting room.

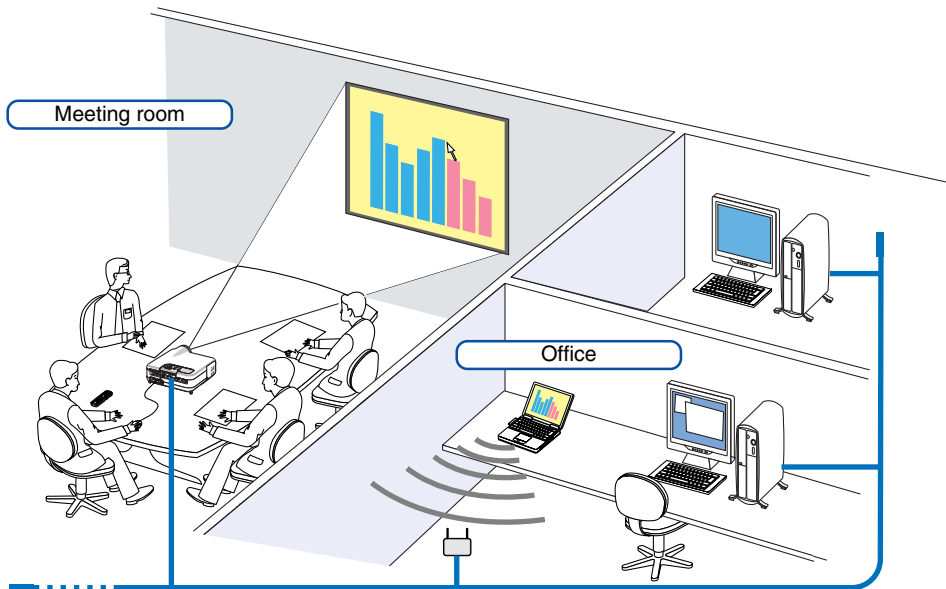

#### Disclaimer

You can use the Desktop Control Utility 1.0 to operate a computer located in a separate room from the projector over a network. This means there might be potential security risks that you may be exposed to which could cause damage by unauthorized access or illegal use. We recommend you take some measures to prevent third parties from unauthorized access to your data or information.

We share neither liability nor responsibility to any loss or damages arising from information leak or power down without notice.

---

*NOTE: In Windows operating system, click "Control Panel" → "Power Options" → "System Standby" → "Never". This will disconnect a LAN connection when the computer goes in standby mode.*

---

---

*NOTE: To use the Desktop Control Utility 1.0, you need to have a USB mouse inserted into the USB port of the projector.*

---



### Operations on the Computer

1. **Connect the computer to the LAN and make the required settings.**
2. **Install Desktop Control Utility 1.0 on the computer.**
  - For instructions on installation, refer to the included "NEC Software Utility Installation Guide".
  - For instructions on operating the software, see the Desktop Control Utility 1.0's help file.
3. **Prepare the documents to be presented at the meeting and save them on the computer.**
4. **Start up Desktop Control Utility 1.0.**

**The Startup password window appears.**

*Window at the first startup*

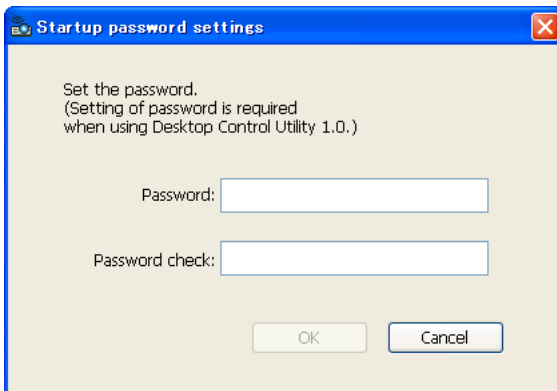

*Window after entering your startup password*

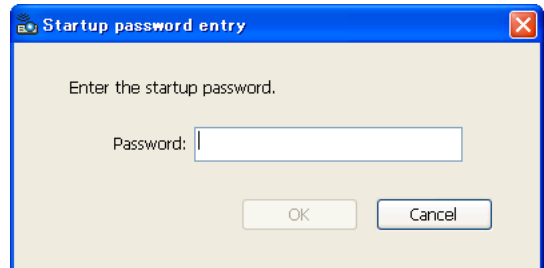

#### Important:

- Your startup password will be required each time you start Desktop Control Utility 1.0.
- If you forget or lost your startup password, install the program again.

5. **Input the startup password and click "OK".**

**The "Current password" input window appears.**

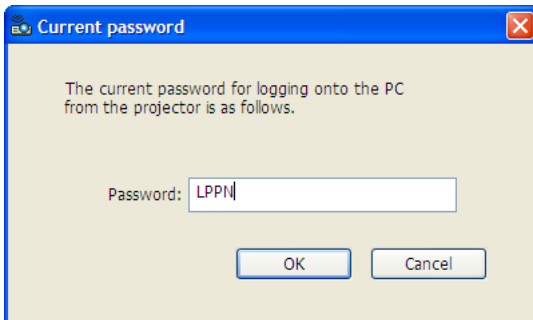

---

*NOTE: The "Current password" will be changed each time you start Desktop Control Utility 1.0.*

---

6. **Make a note of the password.**

7. **Click "OK".**

**Desktop Control Utility 1.0 starts.**

Go to the room where the projector is installed, taking the password you made a note in the previous Step [6].

### Operations on the projector – Connecting to the computer

1. Make the LAN settings on the projector.

Make the LAN settings at [Setup] → [Installation] → [LAN Mode] in the menu. (See page 99)

2. Connect a commercially available USB mouse to the projector. (See page 41)
3. Click anywhere on the screen with the USB mouse.

The menu appears.

4. Click “Source”, then click “LAN”.

The help message is displayed.

The message is displayed only when a password for Desktop Control Utility 1.0 is not assigned.



5. Follow the message to press the MENU button on the projector cabinet or the remote control. The connections bar appears at the bottom left of the screen.



6. Click the password input icon .
7. Click “Entry”.



The password input window appears.

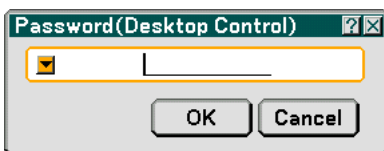

8. Click .

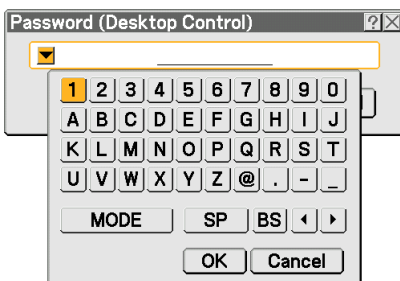

The character input window appears. (See page 132.)

## 4. Convenient Features

9. **Input the password you made a note of in the previous Step [6] in “Operations on the Computer”.**
10. **Input the password and click “OK”.**  
*The password input window is turned off.*

11. **Click the PC search icon .**

*The PC search window appears.*

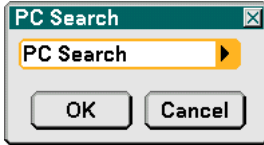

12. **Click “OK”.**

*The connection selection window appears.*

- To search by inputting the IP address of the connected computer, click  on the PC Search window, click “Input IP Address”, then click “OK”.
13. **Click the computer to which you want to connect, then click “OK”.**  
*The desktop of the connected computer appears.*



*NOTE: Once the desktop appears, the menu will no longer appear when the USB mouse is clicked. To display the menu while the desktop is displayed, press the button on the projector itself or on the remote control.*



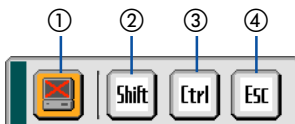

### Operations on the projector –Operating the desktop

A USB mouse connected to the projector can be used to operate the displayed desktop.

If the MENU button on the projector cabinet or the remote control is pressed while the desktop is displayed, an additional operations bar appears at the bottom left of the screen.



The following operations are available only with buttons on the projector cabinet or the remote control.

- ①  Disconnect icon ..... Use to cut off communications with the computer.
- ②  Shift icon ..... Select this icon and press the ENTER button to set the shift lock mode. Select this icon and press the ENTER button again to cancel the shift lock mode.
- ③  Ctrl icon ..... Select this icon and press the ENTER button to set the control lock mode. Select this icon and press the ENTER button again to cancel the control lock mode.
- ④  Esc icon ..... Use to do the same operation as when the “Esc” button on the computer is pressed. Use it for example to stop a PowerPoint slideshow.

### Operations on the projector – Disconnecting communication

1. Press the MENU button while the desktop is displayed.

*The additional operations bar appears at the bottom left of the screen.*



2. Select the disconnect icon  and press the ENTER button.

*The connections bar appears at the bottom left of the screen.*

To reconnect the communication, click the PC search icon  and repeat steps 12 and 13 in the previous page.

---

*NOTE: Disconnection is possible by clicking the projector icon and then "Disconnect" on the task bar.*

---

### Operations on the projector – Exiting the desktop operation

Exiting the desktop operation using the taskbar in Windows.

1. Click the projector icon  on the taskbar while the desktop is displayed.

*The pop-up menu appears.*

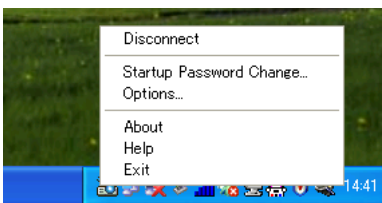

2. Click “Exit”.
- Desktop Control Utility 1.0 quits*
3. Click anywhere on the screen.
- The connections bar appears at the bottom left of the screen.*
4. Click again anywhere on the screen.
- The menu appears.*
5. Click “Source” and then click any other source than “LAN”.
- The menu turns off.*

# 5

## ***Using the Viewer***

.....

① Making the Most out of the Viewer Function .....	63
② Operating the Viewer Function from the Projector (playback) .....	64
③ Changing Background Logo .....	70

# ① Making the Most out of the Viewer Function

## Features

You can view presentation data, capture and play images on the projector. A PC card is used to view presentation data prepared on the computer and to capture and play images projected with the projector.

The Viewer feature allows you to view slides stored on a PC memory card (referred to as PC card in this manual) or USB memory on the projector. Even if no computer is available, presentations can be conducted simply with the projector. This feature is convenient for holding presentations at meetings and in offices, as well as for playing images taken on digital cameras.

---

### NOTE:

- *To use the Viewer, first you need to create presentation materials on your PC (JPEG, BMP, GIF\*1, PNG\*1, Index\*2 files). For creating presentation materials using the Ulead Photo Explore 8.0, see the supplied "NEC Software Utility Installation Guide" or On-line help in Ulead Photo Explorer 8.0.*

*\*1 Both PNG and GIF format support non-interlaced images only.*

*\*2 "Index" file is a file created using the Ulead Photo Explore 8.0 contained on the supplied NEC User Supportware 2 CD-ROM. See the supplied "NEC Software Utility Installation Guide" for installing the Ulead Photo Explore 8.0 on your computer.*

---

## Easy to use

- Presentations can be started immediately simply by inserting a PC card or USB memory (not supplied)
- Easy slide switching
- Remote control operation
- Jumping to a list of slides or any specific slide

## Simple utility software (for computer)

- Ulead Photo Explore 8.0SE Basic operable on Windows XP/Windows 2000.
  - Slides can be created by capturing the currently displayed image.
  - Control screen for displaying lists of slides and editing.
- \* Microsoft, Windows and PowerPoint are registered trademarks of Microsoft Corporation.

## ② Operating the Viewer Function from the Projector (playback)

This section describes the operation for showing slides created using the Viewer function with the projector. It is also possible to make slides directly from the images projected with the projector.

### Projecting slides (Viewer)

Preparation: Use the Capture feature to store graphic files (JPEG, BMP, non-interlaced GIF or non-interlaced PNG files) in a PC card or USB memory inserted into the projector's slot. Or store JPEG or BMP files in a PC card or USB memory inserted into your PC.

1. Insert a PC card into the PC card slot or USB memory into the USB port of the projector.
2. Press the VIEWER button on the remote control or select the "Viewer" from the source list.

*An image stored in the PC card or USB memory will be displayed.*

3. Press the MENU button to display the Viewer menu.

The Viewer menu will appear when you press the MENU button on the remote control or the projector cabinet.

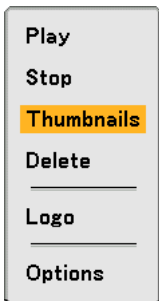

The Viewer menu includes the following commands:

- Play ..... Plays back automatically or manually depending on the setting in Options. This allows you to move on to the next slide when "Manual Play" is selected in the "Play Mode".
- Stop ..... This allows you to stop Auto Play while you are playing back and to resume playing from the selected slide or folder when "Auto Play" is selected in the "Play Mode".
- Thumbnails ..... Displays a list of thumbnails of Graphic files stored in the PC card inserted into the projector.
- Delete ..... Deletes a captured slide(s) or all the captured slides in the Capture - specific folder.
- Logo ..... Replace the default background logo with another logo in JPEG, BMP, non-interlaced GIF or non-interlaced PNG format.
- Options ..... Displays the Viewer setting options.

4. Select "Play" and then press the ENTER button to display the first slide or to start playing slides automatically.

**Viewer Window Elements**

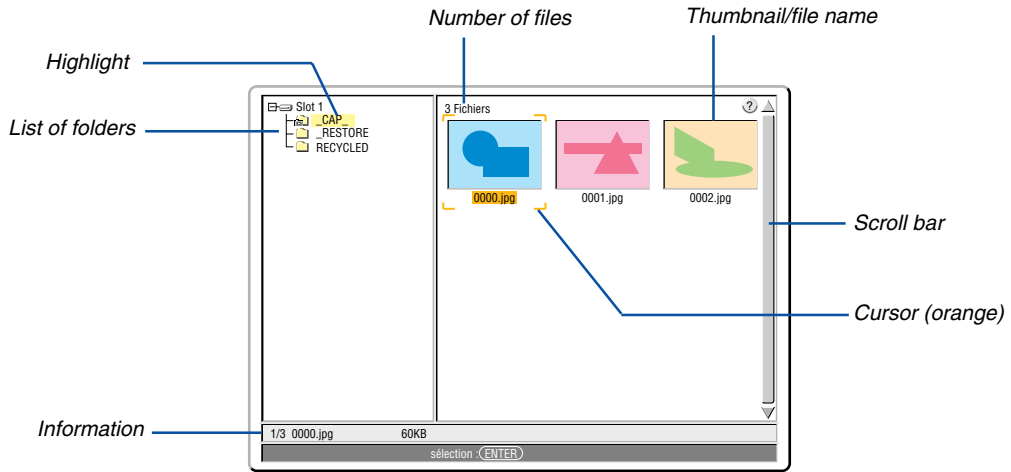

- Highlight ..... Indicates the selected folder or drive.
- List of folders ..... Indicates folders contained on a PC card or USB memory.
- Information ..... Indicates information of the selected file or folder.  
 Folder: folder name, creation date (month/day/year), creation time (hour/minute).  
 File: slide number/number of displayable slides in a folder, file name, creation date (month/day/year), creation time (hour/minute), file size.
- Number of files ..... Indicates number of displayable slides in the selected folder. The maximum number of images recognized as slides within one directory is about 1000.
- Thumbnail/file name ..... Indicates thumbnails and names contained in a folder.
- Cursor ..... Indicates the selected slide.
- Scroll bar ..... Used to view folders or files not visible in the window.



**Setting Option for Viewer**

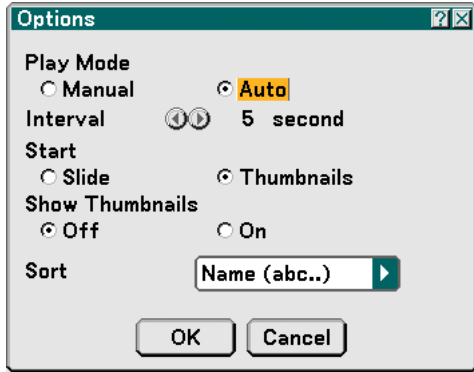

**Play Mode:**

Manual ..... Views a slide manually when the Viewer source is selected.

Auto ..... Plays back slides automatically when the Viewer source is selected.

**Interval:**

Specifies interval time between 5 and 300 seconds.

**Start:**

Specifies start screen when the Viewer source is selected.

**Show Thumbnails:**

Selecting the Viewer source will display a list of thumbnails of graphic files stored in the PC card or USB memory when "On" is selected.

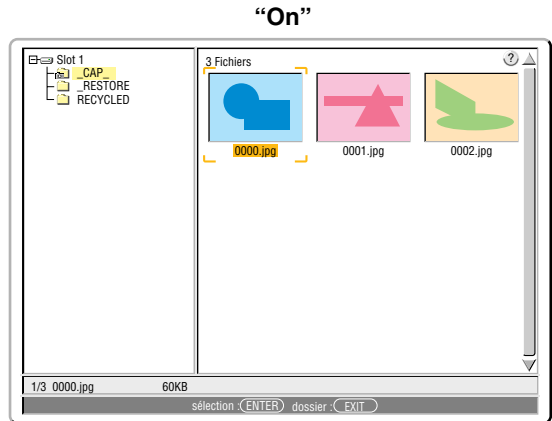
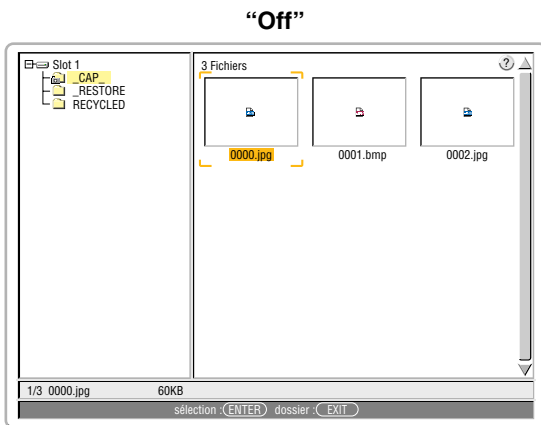

**Sort:**

Rearranges the slides or thumbnails by name, extension, date or size.

*NOTE: This setting is not available for the following folders:*

\* The " \_CAP\_" folder for captured images

\* Folders created with the "Output Viewer" feature of Ulead Photo Explorer 8.0 or with Viewer PPT Converter 3.0

**OK/Cancel:**

To close the Options menu with saving changes, select "OK" and press the ENTER button.

To close the Options menu without saving changes, select "Cancel" and press the ENTER button.

### Exiting Viewer

To exit Viewer, switch to another input such as Computer 1, Computer 2, Video, S-Video or LAN.

- \* To switch to another input, there are two ways:
- \* Press the COMPUTER 1, COMPUTER 2, VIDEO, S-VIDEO or LAN button on the remote control.
- \* Press the MENU button on the remote control to display the Viewer menu. Press the MENU button again to display the main menu and select the input from the "Source" submenu.

With this function it is possible to switch directly to a slide when the picture of a VCR or computer is being projected. Example: When conducting presentations using a combination of slides and moving pictures from a VCR, etc., it is possible to switch from a Viewer slide to the video picture then back to the Viewer slide simply by using the Viewer button.

---

*NOTE: Even if you switch the current Viewer source to another source, the current slide is retained. When you return back to the Viewer, you will get the slide that has been retained.*

---

### Viewing Digital Images

Digital images can be played with the Viewer if the following conditions are met:

- If the image can be stored on an MS-DOS format PC card.
- If the image can be stored in a format supported by the Viewer. With the Viewer, images on the card are searched for in directories and images in JPEG, BMP, non-interlaced GIF or non-interlaced PNG format are recognized as slides.

---

*NOTE: The maximum number of images recognized as slides within one directory is about 1000.*

---

### Deleting Captured Images

Using the Delete command on the Viewer menu allows you to delete captured images.

#### To delete captured images:

Preparation: Make sure that the PC card is inserted into the PC card slot or USB memory into the USB port of the projector.

1. Press the **VIEWER** button on the remote control to display an image.
2. Press the **MENU** button to display the Viewer menu.

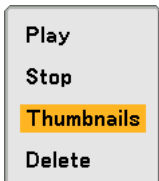

3. Use the **▼** button to select “**Thumbnails**” and then press the **ENTER** button. The Thumbnail screen will be displayed.

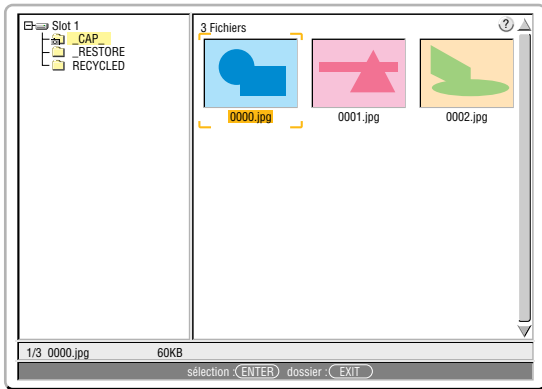

*NOTE: To change highlight from the Thumbnails screen (pane on the right) to a directory tree (pane on the left) , press the **EXIT** button. To return highlight to the Thumbnails screen, press the **ENTER** button.*

4. Use the **▲▼◀▶** buttons to select an image you wish to delete.
5. Press the **MENU** button to display the Viewer menu.
6. Use the **▼** button to select “**Delete**” and then press the **ENTER** button.

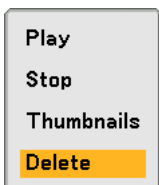

A confirmation message will be displayed.



7. Use the **◀** button to select “**Yes**” and then press the **ENTER** button.

This completes deleting.

To delete all the captured images:

1. Repeat steps 1 to 3 in the above described procedure.
2. Press the EXIT button to select the “ \_\_CAP\_\_ ” folder in the directory (pane on the left).

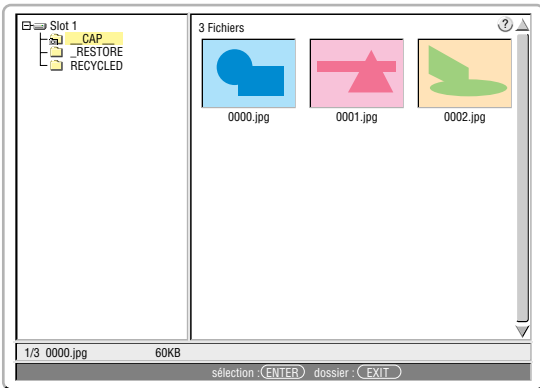

3. Press the MENU button to display the Viewer menu.

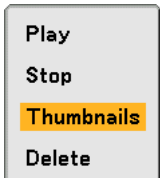

4. Use the ▼ button to select “Delete” and then press the ENTER button.

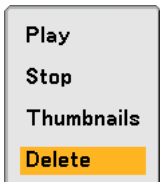

A confirmation message will be displayed.



5. Use the ◀ button to select “Yes” and then press the ENTER button.

This completes deleting.

---

*NOTE: The vacant “ \_\_CAP\_\_ ” folder stays even after you delete all the captured images.*

---

### 3 Changing Background Logo

You can change the default background logo using the Viewer feature.

*NOTE: File size must be 256KB or less. File formats other than JPEG, BMP, non-interlaced GIF or non-interlaced PNG are not available.*

Preparation:

Use the Capture feature to store JPEG or BMP files in a PC card inserted into the projector's slot or USB memory into projector's USB port. Or store JPEG, BMP, non-interlaced GIF or non-interlaced PNG files in a PC card or USB memory inserted into your PC's slot or USB port and insert the PC card into the projector's slot or USB memory into the projector's USB port.

1. Press the **VIEWER** button on the remote control to display an image.
2. Press the **MENU** button to display the Viewer menu.

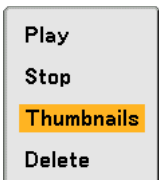

3. Use the **▼** button to select "Thumbnails" and then press the **ENTER** button.  
The Thumbnail screen will be displayed.

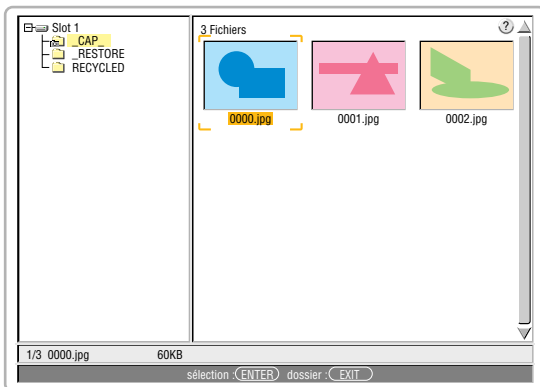

*NOTE: To change highlight from the Thumbnails screen (right window) to a directory tree (left window), press the **EXIT** button. To return highlight to the Thumbnails screen, press the **ENTER** button.*

4. Use **▲▼◀▶** button to select a file (slide) for your background logo.
5. Press the **MENU** button to display the Viewer menu.
6. Use the **▼** button to select "Logo" and then press the **ENTER** button.  
A confirmation dialog box will be displayed.



7. Use the **◀** button to select "Yes" and press the **ENTER** button. This completes changing a logo for the background.

\* Once you have changed the background from the NEC logo to another, you cannot return the logo to background even by using "Reset". To put the NEC logo back in the background logo, repeat the above steps. The NEC logo file is included on the supplied User Supportware 2 CD-ROM (/Logo/nec\_b\_x.jpg).

# 6

## ***Using On-Screen Menu***

.....

1	Using the Menus .....	72
2	Menu tree .....	73
3	Menu Elements .....	75
4	Menu Descriptions & Functions [Source] .....	76
5	Menu Descriptions & Functions [Adjust] .....	79
6	Menu Descriptions & Functions [Setup] .....	90
7	Menu Descriptions & Functions [Information] .....	112
8	Menu Descriptions & Functions [Reset] .....	116

## ① Using the Menus

1. Press the **MENU** button on the remote control or the projector cabinet to display the menu.

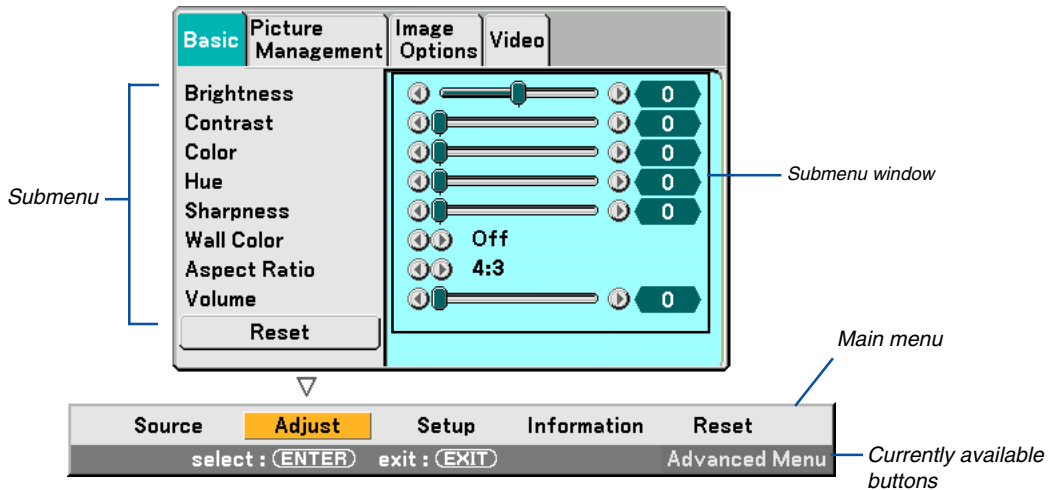

*NOTE: The commands such as ◀▶, ENTER, EXIT in the gray bar show available buttons for your operation.*

2. Press the **SELECT** ◀▶ buttons on the remote control the projector cabinet to display the submenu.
3. Press the **ENTER** button on the remote control or the projector cabinet to highlight the top item or the first tab.
4. Use the **SELECT** ▲▼ buttons on the remote control or the projector cabinet to select the item you want to adjust or set.  
You can use the **SELECT** ◀▶ buttons on the remote control or the projector cabinet to select the tab you want.

*NOTE: You can select a tab only when the tab color is orange.*

5. Press the **ENTER** button on the remote control or the projector cabinet to display the submenu window.
6. Adjust the level or turn the selected item on or off by using the **SELECT** ▲▼◀▶ buttons on the remote control or the projector cabinet.  
Changes are stored until you adjust it again.
7. Repeat steps 2-6 to adjust an additional item, or press the **EXIT** button on the remote control or the projector cabinet to quit the menu display.

*NOTE: When a menu or message is displayed, several lines of information may be lost, depending on the signal or settings.*

## 2 Menu tree

Basic menu items are indicated by shaded area.

Menu	Item					
Source		Computer1, Computer2, Video, S-Video, Viewer, LAN, Entry List				
Adjust	Basic	Brightness				
		Contrast				
		Color				
		Hue				
		Sharpness				
		Wall Color	Off, Blackboard, Light yellow, Light green, Light blue, Sky blue, Light rose, Pink			
		Aspect Ratio	4:3	4:3, Letterbox, Wide Screen, Crop		
			16:9	4:3 Window, Letterbox, Wide Screen, 4:3 Fill		
		Volume				
		Reset				
	Picture Management	Preset	1 to 5			
			Detail Settings	Reference	Presentation, Video, Movie, Graphic, sRGB	
				Gamma Correction	Dynamic, Natural, Black Detail	
			Color Temperature	5000, 6500, 7200, 7800, 8500, 9300		
			White Peaking			
			Black Expansion	On, Off		
			White Balance	Brightness RGB, Contrast RGB		
			Color Correction	Red, Green, Blue, Yellow, Magenta, Cyan, Color Gain		
		Signal Type	RGB, Component			
		Video Filter	Off, Less, More			
Image Options	Clock					
	Phase					
	Horizontal Position					
	Vertical Position					
	Blanking	Top, Bottom, Left, Right				
	Resolution	Auto, Native				
	Overscan	0%, 5%, 10%				
Video	Noise Reduction	Off, Low, Medium, High				
	Color Matrix	HDTV, SDTV				
	3D Y/C Separation	Off, On				
	Vertical Enhancer	Off, 1, 2, 3				
	I/P Converter	Deinterlace(Auto/Still), Interlace				
Setup	Basic	Keystone	Auto, Manual			
		Cornerstone				
		Lamp mode	Normal, Eco			
		Menu Mode	Basic Menu, Advanced Menu			
		Language	English, Deutsch, Français, Italiano, Español, Svenska, Suomi, Norsk, Nederlands, Türkçe, Polski, Русский, Ελληνικά, Magyar, Português, Čeština, العربية, Dansk, 日本語, 한국어, 中文			
Menu	Menu Color Select	Color1 to 5, Monochrome				
	Display Select	Source: On, Off / Message: On, Off				
	Menu Display Time	Manual, Auto 5 sec, Auto 15 sec, Auto 45 sec				
	Background	Blue, Black, Logo				
Security	Cabinet Button	Unlock, Lock				
	Password (Menu)	Entry, Delete				
	Password (Logo)	Entry, Delete				
	Security	Enable, Disable, Keyword, Use Protect Key, Drive, Read, Register, Delete				



Menu	Item			
Setup	Installation	Orientation	Desktop Front, Ceiling Rear, Desktop Rear, Ceiling Front	
		Screen	Screen Type: 4:3, 16:9 / Position	
		LAN Mode	Built-in	
			PC Card	Advanced: Network Type, Wep
			Domain	
			Mail	
			Projector Name	
		Communication Speed	4800, 9600, 19200, 38400	
		Options	Auto Adjust	Off, Normal, Fine
			Auto Start	Off, On
	Power Management		Off, On	
	Fan Mode		Auto, High	
	Default Source Select		Last, Auto, Select (Computer1/2, Video, S-Video, Viewer, LAN)	
	Signal Select		Computer1	RGB/Component, RGB, Componet, Scart
			Computer2	RGB/Component, RGB, Componet
			Video	Auto, NTSC3.58, NTSC4.43, PAL, PAL-M, PAL-N, PAL60, SECAM
			S-Video	Auto, NTSC3.58, NTSC4.43, PAL, PAL-M, PAL-N, PAL60, SECAM
	OUT Terminal		Last, Computer1, Computer2	
	Tools	ChalkBoard		
		Off Timer	Off, 0:30, 1:00, 2:00, 4:00, 8:00, 12:00, 16:00	
Mouse		Mouse Pointer: Pointer 1 to 9 / Button: Right Hand, Left Hand / Sensitivity: Fast, Medium, Slow		
Pointer		Pointer 1 to 9		
Information	Usage Time	Remaining Lamp Time, Lamp Hour Meter, Projector Usage		
	Source Page1	Input Terminal, Signal Type, Video Type, Source Name, Entry No.		
	Source Page2	Horizontal Frequency, Vertical Frequency, Sync Type, Sync Polarity, Interlace		
	LAN Built-in	IP Address, Subnet Mask, Gateway, MAC Address		
	LAN PC Card	IP Address, Subnet Mask, Gateway, MAC Address		
	LAN Wireless	SSID, Mode, WEP, Channel, Signal Level		
	Version	Firmware, Data		
Reset	Current Signal, All Data, All Data (Including Entry List), Clear Lamp Hour Meter			

### 3 Menu Elements

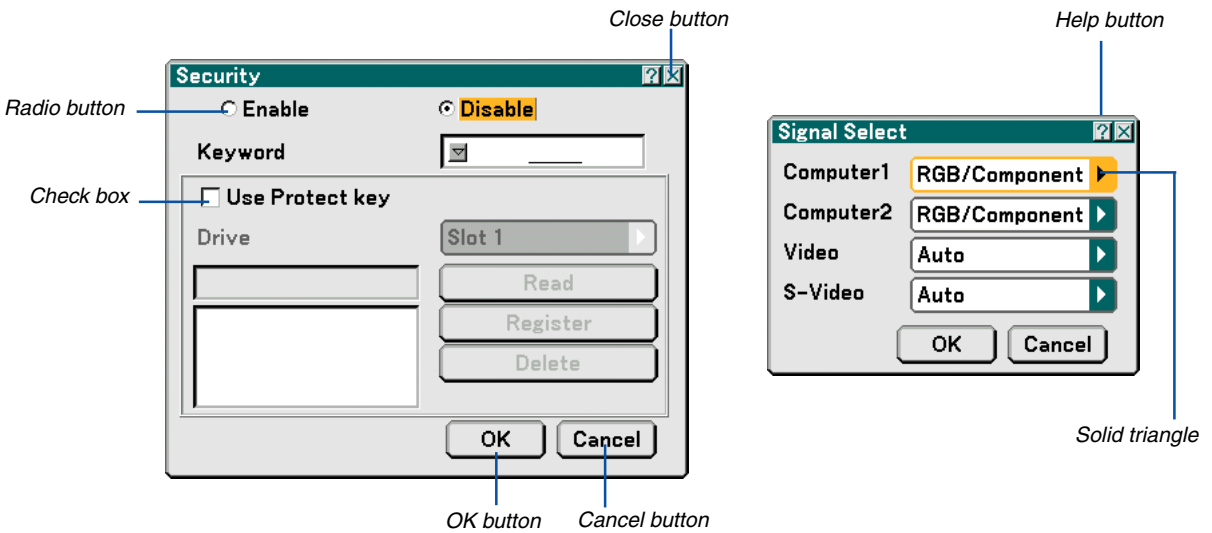
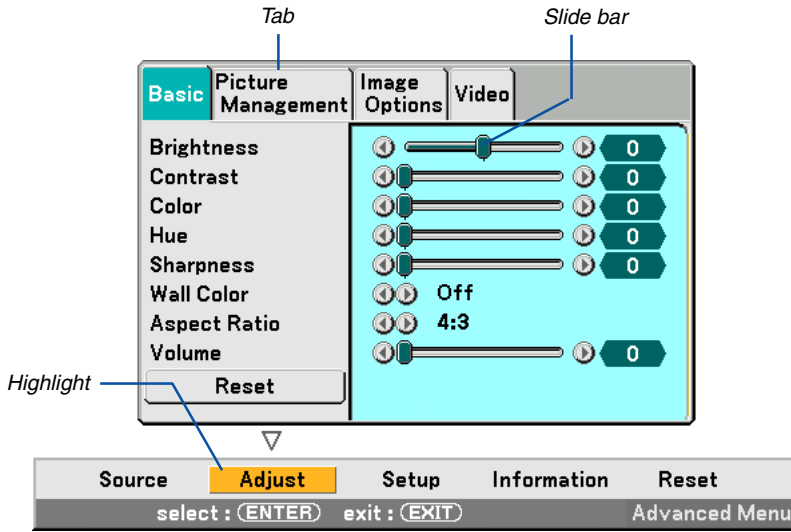

**Menu windows or dialog boxes typically have the following elements:**

- Highlight..... Indicates the selected menu or item.
- Solid triangle ..... Indicates further choices are available. A highlighted triangle indicates the item is active.
- Tab ..... Indicates a group of features in a dialog box. Selecting on any tab brings its page to the front.
- Radio button ..... Use this round button to select an option in a dialog box.
- Check box ..... Place a checkmark in the square box to turn the option On.
- Slide bar ..... Indicates settings or the direction of adjustment.
- OK button ..... Press to confirm your setting. You will return to the previous menu.
- Cancel button ..... Press to cancel your setting. You will return to the previous menu.
- Close button ..... Click to close the window and saving changes. (USB mouse only)
- Help button ..... Indicates that help about that feature is available (USB mouse only). Press the HELP button on the remote control to display help.

## 4 Menu Descriptions & Functions [Source]



### Computer 1 and 2

Selects the computer connected to your Computer 1 or Computer 2 input connector signal.

*NOTE: An optional component cable (Component V or ADP-CV1 cable) is needed for a component signal.*

### Video

Selects what is connected to your Video input-VCR, laser disc player, DVD player or document camera.

### S-Video

Selects what is connected to your S-Video input-VCR, DVD player, or laser disc player.

*NOTE: A frame may freeze for a brief period of time when a video is played back in fast-forward or fast-rewind with a Video or S-Video source.*

### Viewer

This feature enables you to make presentations using a PC card that contains captured images and slides created with the exclusive Photo Explore 8.0 for NEC contained on the CD-ROM. See the supplied NEC Software Utility Installation Guide for installing the Photo Explore 8.0 for NEC.

See page 62 for viewing slides.

### LAN

Selects a signal from the LAN port (RJ-45) or the NEC optional wireless LAN card plugged into the projector's card slot.

## Entry List

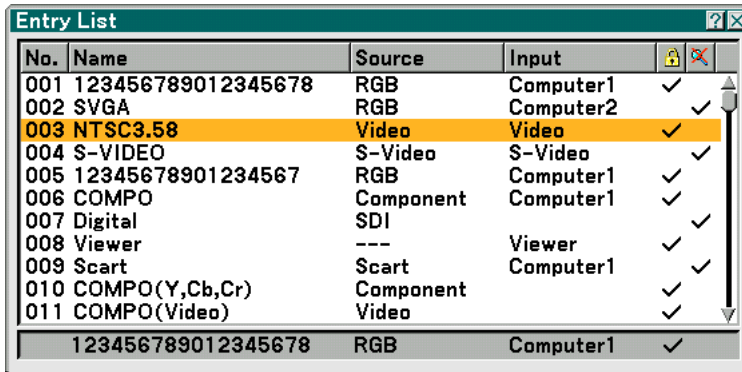

No.	Name	Source	Input	
001	123456789012345678	RGB	Computer1	✓
002	SVGA	RGB	Computer2	✓
003	NTSC3.58	Video	Video	✓
004	S-VIDEO	S-Video	S-Video	✓
005	12345678901234567	RGB	Computer1	✓
006	COMPO	Component	Computer1	✓
007	Digital	SDI		✓
008	Viewer	---	Viewer	✓
009	Scart	Scart	Computer1	✓
010	COMPO(Y,Cb,Cr)	Component		✓
011	COMPO(Video)	Video		✓
123456789012345678		RGB	Computer1	✓

Use the SELECT ▲▼ buttons on your remote control or the projector cabinet to select the signal and press the ENTER button on the remote control or the projector cabinet to display the Entry Edit Command screen.

### Entering the Currently Projected Signal into the Entry List

1. *Display the Entry List.*
2. *Use the SELECT ▲ or ▼ button on your remote control or the projector cabinet to select any number and press the ENTER button on the remote control or the projector cabinet to display the Entry Edit Command screen.*
3. *Use the SELECT ◀ or ▶ button to select "Store" and press the ENTER button.*

### Using the Entry List

Making any adjustments to the current picture will automatically register its adjustments to the Entry List. The registered signal can be loaded any time from the Entry List.

---

*NOTE: Up to 100 presets can be registered except settings on the Picture.*

---

Entry Edit Command



You can edit signals on the Entry List.

- Load ..... Enables you to select a signal from the list.
- Store ..... Enables you to store the currently projected signal.
- Cut ..... Enables you to remove a selected signal from the list and place it on the "clipboard" in the projector.
- Copy ..... Enables you to copy a selected signal from the list and place it on the "clipboard" in the projector.
- Paste ..... Enables you to paste the signal placed on the "clipboard" to any other line of the list.
- Edit ..... Enables you to change source names.

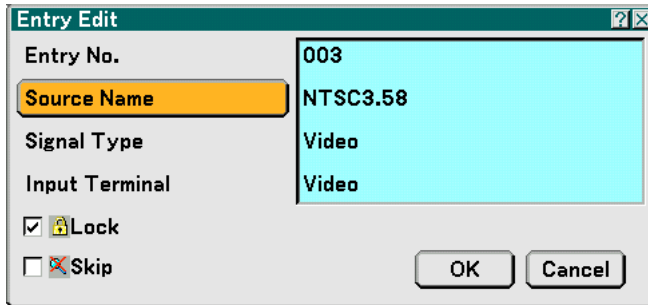

**Source Name:**

Enter a signal name. Up to 18 alphanumeric characters can be used.

**Input Terminal:**

Change the input terminal.

**Lock:**

Set so that the selected signal cannot be deleted when "All Delete" is executed. After executing "Lock", the changes cannot be saved.

**Skip:**

Set so that the selected signal will be skipped during auto search.

When complete, select OK and press ENTER. To exit without storing the setting, select Cancel. Select "Source Name" and press ENTER to display the Source Name Edit window. You can change source name on this window. Press ▼ to display the software keyboard, which you can enter alphanumeric characters. See page 132 for the key function of the software keyboard.

- All Delete ..... This feature enables you to delete all the registered signals in the Entry List.

The following buttons are not available for the currently projecting signals:

- 1) The Cut and Paste buttons on the Entry Edit Command screen
- 2) The Input Terminal button on the Entry Edit screen

*NOTE: When all the signals in the Entry List are deleted, the currently projected signal will be also deleted except locked signals.*

## 5 Menu Descriptions & Functions [Adjust]

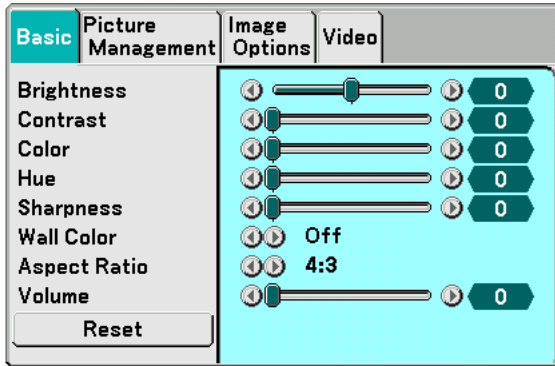

### Basic

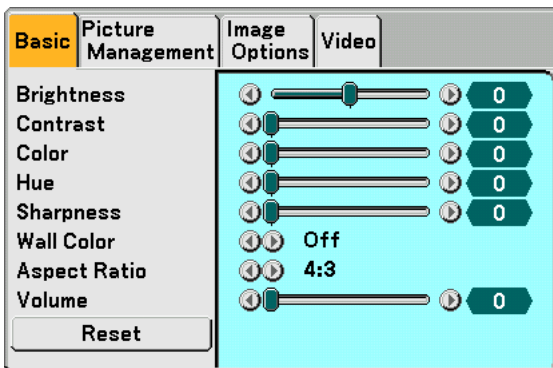

### [Brightness]



Adjusts the brightness level or the back raster intensity.

### [Contrast]



Adjusts the intensity of the image according to the incoming signal.

### [Color]



Increases or decreases the color saturation level (not valid for RGB).

### [Hue]



Varies the color level from +/- green to +/-blue. The red level is used as reference. This adjustment is only valid for Video, Component and TV standard inputs (not valid for RGB).

### [Sharpness]



Controls the detail of the image for Video (Not valid for RGB).

### Using the Wall Color Correction [Wall Color]

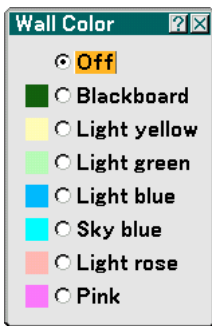

This function allows for quick adaptive color correction in applications where the screen material is not white. The following eight options are available.

- OFF
- Blackboard
- Light yellow
- Light green
- Light blue
- Sky blue
- Light rose
- Pink

Selecting Aspect Ratio [Aspect Ratio] (not available for Viewer)

Screen Type 4:3

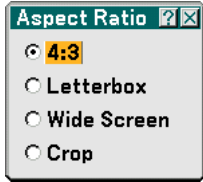

Screen Type 16:9

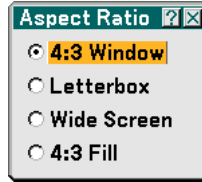

Aspect Ratio allows you to select the best Aspect mode to display your source image. When screen type 4:3 is selected for the source, the following selections will display:

- 4:3 ..... Standard 4:3 aspect
- Letter Box ..... Reduced to display the true aspect with black borders on top and bottom
- Wide Screen ..... Left & Right stretched with black borders on top and bottom
- Crop ..... Left & Right stretched. Left & Right sides cut. Available for 4:3 only.

When screen type 16:9 is selected for the source, the following selections will display:

- 4:3 Window ..... Reduced to display the true aspect with black borders on right and left
- Letter Box ..... Standard 16:9 aspect
- Wide Screen ..... Left and right stretched to display the true aspect
- 4:3 Fill ..... Stretched to display in 16:9 aspect ratio











*NOTE: You can adjust image position vertically for a source with black borders on top and bottom. See page 98 for setting image position.*

*Copyright*

*Please note that using this projector for the purpose of commercial gain or the attraction of public attention in a venue such as a coffee shop or hotel and employing compression or expansion of the screen image with a "Aspect Ratio" or "Screen" setting may raise concern about the infringement of copyrights which are protected by copyright law.*

*NOTE: During 3D Reform adjustment, "Aspect Ratio" may not be available.*

*Should this happen, first reset the 3D Reform data and then do setting again. Second repeat the 3D Reform adjustment. Changing the aspect ratio can limit 3D Reform in its adjustable range.*

Input Signal Screen Type	 4:3	 Letterbox	 Squeeze
4:3 Screen	 4:3	 Letterbox	  Wide Screen    Crop
16:9 Screen	  4:3 Window    4:3 Fill	 Letterbox	 Wide Screen



### Controlling Volume [Volume]



You can adjust the volume level of the projector speakers and AUDIO OUT (Stereo Mini Jack).

### Reset

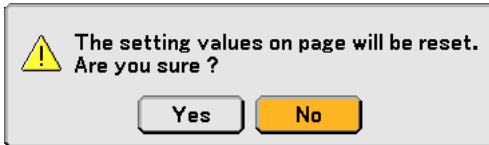

To reset the settings for "Basic", select "Reset" and press the ENTER button.

The message "The setting values on page will be reset. Are you sure?" will be displayed.

Select "Yes" and press the ENTER button. To return without storing settings, select "No" and press the ENTER button.

### Picture Management

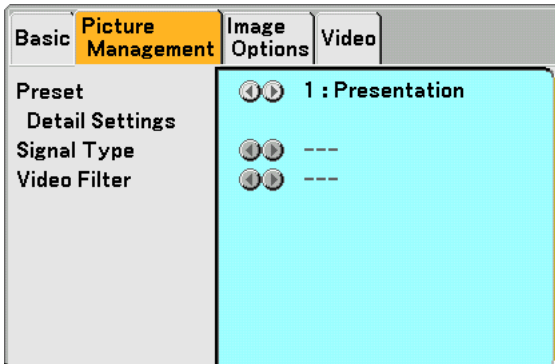

### [Preset]

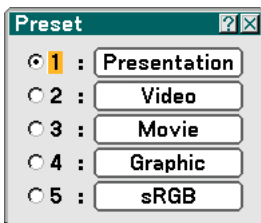

This option allows you to adjust neutral tint for yellow, cyan or magenta. There are 5 factory presets optimized for various types of images, you can set user adjustable settings.

[Detail Settings]

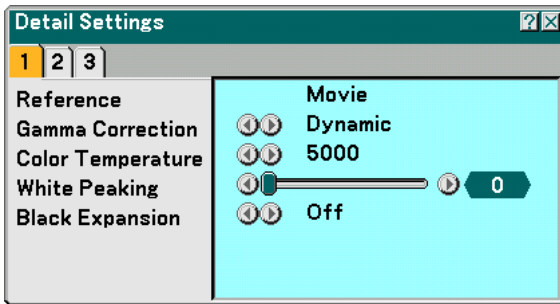

This will provide you with three pages of menus that provide more detailed settings.

[Page1]

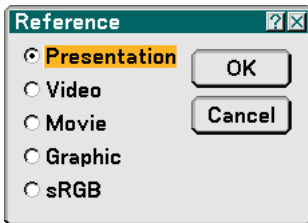

Selecting Reference Setting [Reference]

This feature allows you to use color correction or gamma values as reference data to optimize for various types of images. You can select one of the following five settings.

- Presentation ..... Recommended for making a presentation using a PowerPoint file.
- Video ..... Recommended for regular picture such as TV program.
- Movie ..... Recommended for movies.
- Graphic ..... Recommended for graphics.
- sRGB ..... Standard color values.

Selecting Gamma Correction Mode [Gamma Correction]

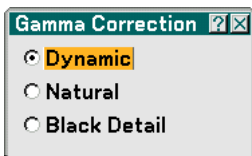

Each mode is recommended for:

- Dynamic ..... Creates a high-contrast picture.
- Natural ..... Natural reproduction of the picture.
- Black Detail ..... Emphasizes detail in dark areas of the picture.

Adjusting Color Temperature [Color Temperature]



This feature adjusts the color temperature using the slide bar. The range is between 5000K and 9300K.

**NOTE:**

- \* When "Presentation" is selected in "Reference", this function is not available.
- \* When "White Balance" settings has been changed, the color temperature value on screen does not reflect the real color temperature.

### Adjusting Brightness of White Area [White Peaking]



Adjust the brightness of the white areas by using the slide bar. As the picture becomes dim, it looks more natural.

### [Black Expansion]

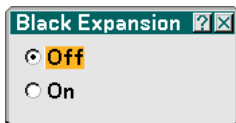

Automatically minimizes blacks that appear more like shades of gray to provide a true black and white image. The "On" is the factory preset.

*NOTE: This feature is not available for Scart, 480p, 576p, HDTV and RGB signals.*

### [Page 2]

### Adjusting White Balance [White Balance]

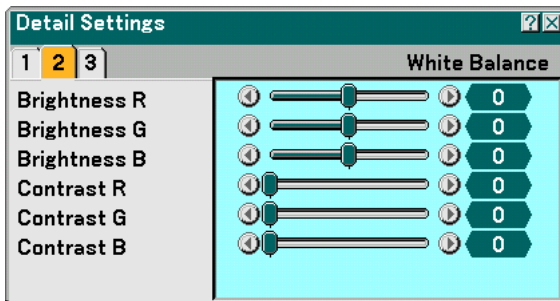

This allows you to adjust the white balance. Brightness for each color (RGB) is used to adjust the black level of the screen; Contrast for each color (RGB) to adjust the white level of the screen.

### [Page 3]

### Selecting Color Correction [Color Correction]

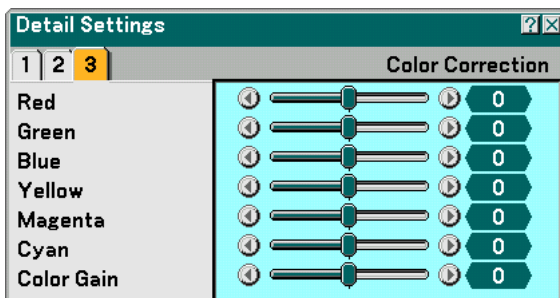

Adjusts red, green, blue, yellow, magenta and cyan each independently to correct the tint of the whole screen.

### Selecting Signal Type [Signal Type]

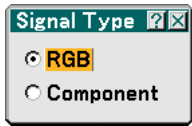

Select either the computer signal type or the component signal type.

RGB ..... Computer signal

Component ..... Component signals such as Y/Cb/Cr, Y/Pb/Pr

---

*NOTE: This feature is available on the computer signal only. If you do not get a better picture even when you set "Signal Select" to "Component" in Setup, set this to "Component".*

---

### Selecting Video Filter Level [Video Filter] (not available for Video, Viewer and LAN)

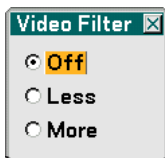

This function reduces video noise.

Off ..... The filter is removed.

Less ..... The low-pass filter is applied partially.

More ..... The low-pass filter is applied fully.

### Image Options

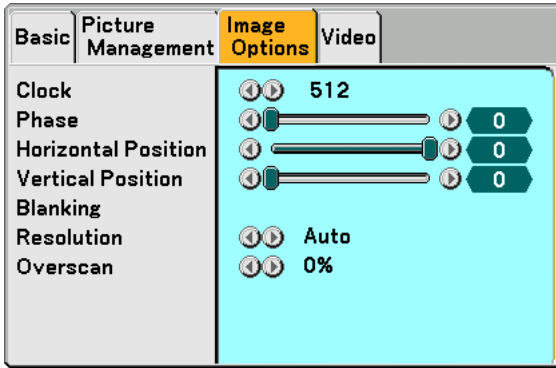

#### Adjusting Clock and Phase [Clock/Phase]



This allows you to manually adjust Clock and Phase.

- Clock ..... Use this item to fine tune the computer image or to remove any vertical banding that might appear. This function adjusts the clock frequencies that eliminate the horizontal banding in the image. This adjustment may be necessary when you connect your computer for the first time.
- Phase ..... Use this item to adjust the clock phase or to reduce video noise, dot interference or cross talk. (This is evident when part of your image appears to be shimmering.) Use "Phase" only after the "Clock" is complete.

#### Adjusting Horizontal/Vertical Position [Horizontal/Vertical Position]



Adjusts the image location horizontally and vertically.

#### Masking Unwanted Area [Blanking]

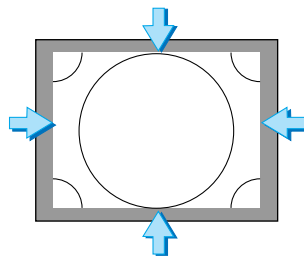
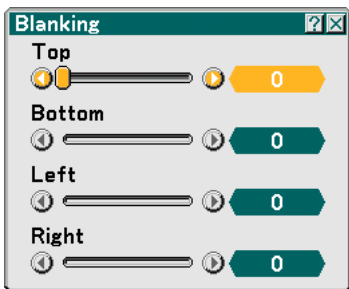

This feature allows you to mask any unwanted area of the screen image. Adjust the Top, Bottom, Left or Right blanking with the SELECT ◀ or ▶ button.

### Selecting Resolution [Resolution]

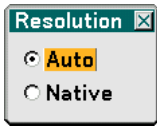

This allows you to activate or deactivate the Advanced AccuBlend feature.

Auto ..... Turns on the Advanced AccuBlend feature. The projector automatically reduces or enlarges the current image to fit the full screen.

Native ..... Turns off the Advanced AccuBlend feature. The projector displays the current image in its true resolution. See "Auto Adjust" on page 107 for turning on or off the Auto Adjust feature.

---

**NOTE:**

\* When "Resolution" is set to "Native", "Overscan", "3D Reform", "Aspect Ratio" and "Screen" are not available.

\* While you are displaying an image with the projector's native resolution or higher, "Resolution" is not available.

---

### Selecting Overscan Percentage [Overscan]

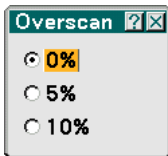

Select overscan percentage (0%, 5% and 10%) for signal.

## Video

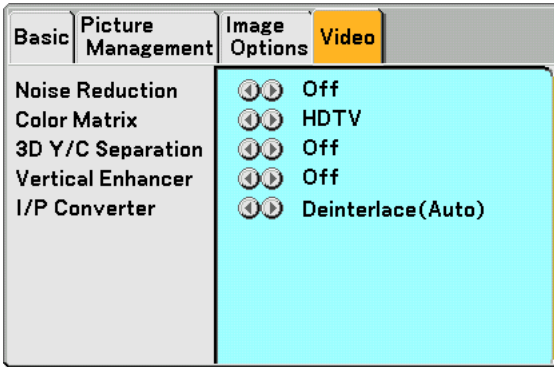

### Selecting Noise Reduction Level [Noise Reduction]

(not available for COMPUTER1/2, Viewer and LAN; available for TV standard inputs)

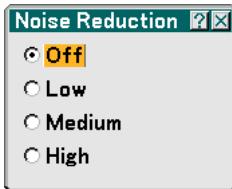

Select one of the three levels for reducing video noise: Low, Medium or High.

---

*NOTE: The lower the Noise Reduction level, the better the image quality by way of higher video bandwidth.*

---

### Selecting Color Matrix [Color Matrix]

(not available for COMPUTER1/2, Viewer and LAN; available for TV standard inputs)



Select an appropriate color matrix for your input signal, either HDTV or SDTV.

### Turning On/Off 3 Dimension Separation [3D Y/C Separation]

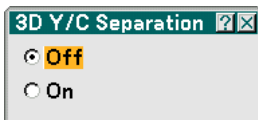

This function turns on or off the 3 dimensional separation feature.

---

*NOTE: This feature is available for NTSC3.58 of Video signal only.*

---

### Setting Vertical Edges [Vertical Enhancer]

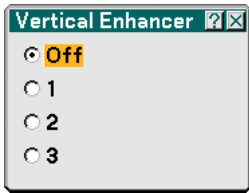

This function enhances the vertical edges around objects in the image.

---

*NOTE: This function is not available for an RGB and Component signal.*

---

### Selecting Interlace or Deinterlace [I/P Converter]

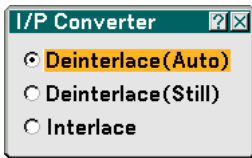

This function allows you to select between "Interlace" and "Deinterlace".

Deinterlace (Auto) ..... The projector automatically determines a still or moving image to display a clear picture. If selecting "Deinterlace (Auto)" causes excess jitter or artifacts, select "Interlace".

Deinterlace (Still) ..... Select when a still image is displayed. When this option is selected for a moving image, jitter or artifacts can be seen.

Interlace ..... Select when a moving image is displayed. This will eliminate jitter and artifacts in a moving image.



## 6 Menu Descriptions & Functions [Setup]

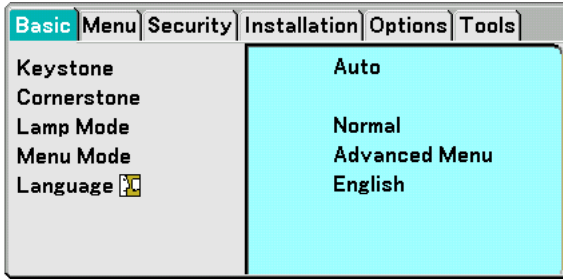

### Basic

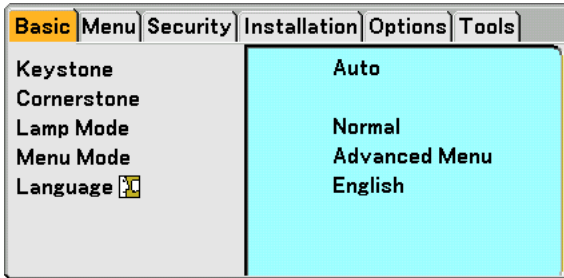

### Selecting Keystone Mode [Keystone]

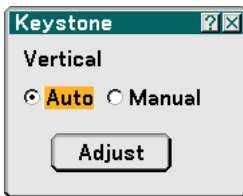

This feature allows you to correct keystone distortion manually or automatically. Selecting this item will display the Keystone setting menu.

Auto ..... This feature allows the projector to detect its tilt and correct vertical distortion automatically.

Manual ..... You can correct vertical distortion manually from the menu.

Changes will be saved even when you turn off the projector.

Adjust ..... You can display the Keystone screen. See page 33 for more details.

---

*NOTE: When "Cornerstone" is selected, "Adjust" is not available.*

**Selecting Cornerstone Mode [Cornerstone]**

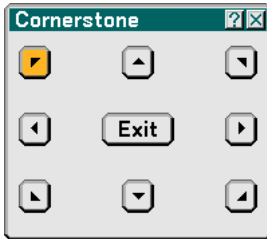

This option allows you to correct trapezoidal distortion. Selecting this item will display the Cornerstone adjustment screen. See page 43 for more details.

---

*NOTE: When "Keystone" is selected, "Cornerstone" is not available.*

---

**Setting Lamp Mode to Normal or Eco [Lamp Mode]**

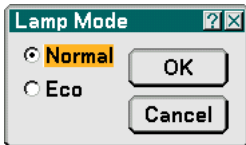

This feature enables you to select two brightness modes of the lamp: Normal and Eco modes. The lamp life can be extended up to 4000 hours by using the Eco mode. Selecting Eco mode decreases fan noise compared to in Normal mode.

- Normal Mode ..... This is the default setting (100% Brightness).
- Eco Mode ..... Select this mode to increase the lamp life (80% Brightness).

**Selecting Menu Mode [Menu Mode]**

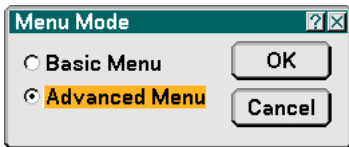

This feature allows you to select two menu modes: Basic Menu and Advanced Menu.

- Basic Menu ..... This is the basic menu that contains minimum essentials of menus and commands.
- Advanced Menu ..... This is the menu that contains all the available menus and commands.

**Selecting Menu Language [Language]**

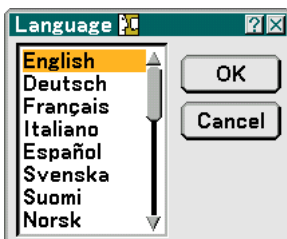

You can choose one of 21 languages for on-screen instructions.

**Menu**

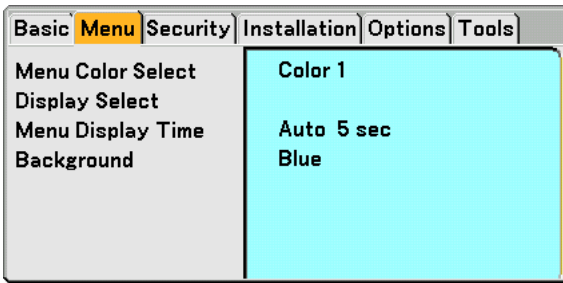

**Selecting Menu Color [Menu Color Select]**

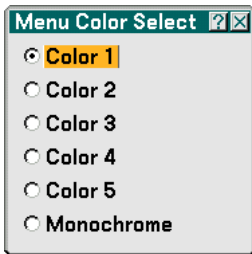

You can choose a color for the menu.

**Turning On / Off Source Display and Message [Display Select]**

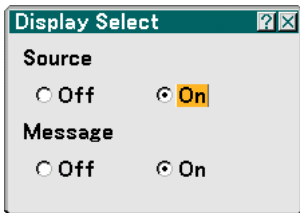

Source ..... This option turns on or off input name display such as Computer 1/2, Video, and No Input to be displayed in the top right corner of the screen.

Message ..... This option turns on and off messages. Even though selecting “Off”, the following message will appear.  
 \* “The lamp has reached the end of its usable life. Please replace the lamp.” Press the EXIT button and the message will disappear.  
 \* “Projector is locked” When unlocking the projector security, the message will disappear.

Selecting Menu Display Time [Menu Display Time]

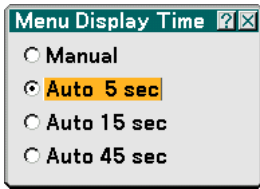

This option allows you to select how long the projector waits after the last touch of a button to turn off the menu. The preset choices are "Manual", "Auto 5 sec", "Auto 15 sec", and "Auto 45 sec". The "Auto 45 sec" is the factory preset.

Manual ..... The menu can be turned off manually.

Auto 5 sec ..... The menu will automatically be turned off in 5 seconds if no buttons are pressed within 5 seconds.

Auto 15 sec ..... The menu will automatically be turned off in 15 seconds if no buttons are pressed within 15 seconds.

Auto 45 sec ..... The menu will automatically be turned off in 45 seconds if no buttons are pressed within 45 seconds.

Selecting a Color or Logo for Background [Background]



Use this feature to display a blue/black screen or logo when no signal is available. The default background is blue. You can change the logo screen using the Viewer feature. See pages 70.

Security

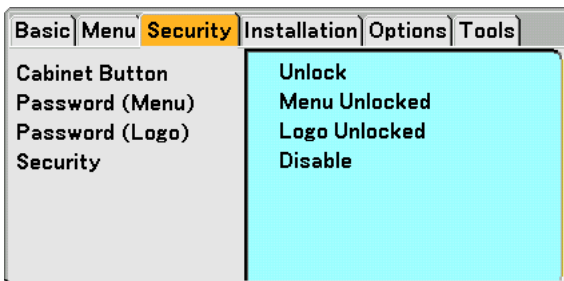

Disabling the Cabinet Buttons [Cabinet Button]

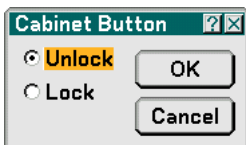

This option turns on or off the Cabinet Button Lock function.

NOTE:

- This Cabinet Button Lock does not affect the remote control functions.
- When the cabinet buttons are locked, pressing and holding the EXIT button for about 10 seconds will change the setting to unlock.

### Setting a Password [Password (Menu)] / [Password (Logo)]

A password can be set for your projector to avoid operation by an unauthorized person.

When "Password (Menu)" is set, changing the menu from Basic to Advanced will display "Password (Menu)" input screen.

When "Password (Logo)" is set, doing any one of the following two operations will display the Password input screen.

- Changing the background
- Changing the logo data in a PC card

#### Entry:

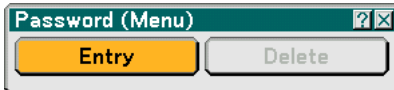

To assign your password:

---

*NOTE: Up to 15 alphanumeric characters can be assigned.*

---

#### 1. Type a password.

**Highlight "Entry" and press the ENTER button.**

**The "Enter the Password" screen will be displayed.**



**Make sure that  is highlighted and then press the ENTER button.**

**The Software keyboard appears. Use the Software keyboard to type a password and then highlight "OK" on the "Enter the Password" screen and press the ENTER button.**

**The [Confirm Password] screen will be displayed.**

#### 2. Type the same password again. Highlight "OK" on the "Enter the Password" screen and press the ENTER button.

**Your password will be assigned.**

#### Delete:

To delete your password:

#### 1. Highlight [Delete] and press the ENTER button. The "Current Password" screen will be displayed.



#### 2. Use the Software keyboard to type your password. Highlight "OK" on the "Current Password" screen and then press the ENTER button.

**Your password will be deleted.**

## Security

The Security function enables you to protect your projector so that the projector will not project a signal unless you enter a keyword. There is also an option to lock the projector by using a registered PC card\* as a protect key. Once you have registered your PC card as a protect key, you are required to insert the registered PC card into the PC card slot of the projector each time you turn on the projector. You can enable the Security function by using a keyword only.

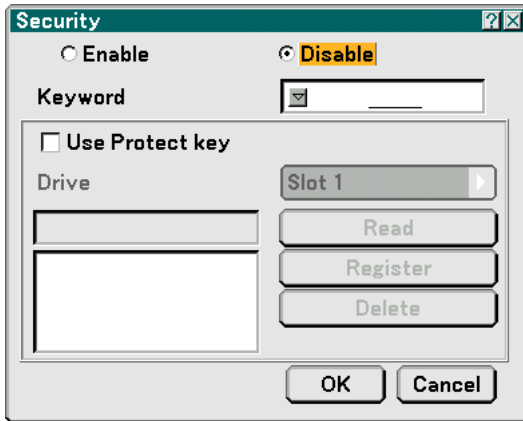

- \* The projector does not support NTFS formatted flash memory card or USB memory device. Be sure to use a flash memory card or USB memory device formatted with the FAT32, FAT16 or FAT file system. To format your flash memory card or USB memory device in your computer, refer to the document or help file that comes with your Windows.

Enable/Disable ..... This turns the Security function on or off.

Keyword ..... Enter an appropriate keyword when you use the Security function. (Up to 10 characters can be used.) The Security function is available only when your keyword is entered.

Use Protect key ..... Check this box to lock your projector when using a PC card. To use a keyword without a PC card, do not check this box.

Drive ..... Switches between PC Card slot and USB port (type A).

Read ..... Reads data from a PC card.

Register ..... Registers data from the PC card. The Security function is not available unless at least one PC card is registered. (if the "Use Protect key" check box is selected) Up to 5 PC cards can be registered.

Delete ..... Deletes data of a registered PC card.

To set up a keyword to enable the Security function without using a registered PC card.

1. Use the **SELECT ▲▼** button to select "Keyword" and use the software keyboard to enter a keyword.

*NOTE: Please make a note of your keyword.*

2. Use the **SELECT ▲▼** button to select "Enable" and use the **SELECT ▲▼** button to select "OK", then the Security function will be enabled.

An "Are you sure?" message will appear. Use the **SELECT ◀▶** button to select "Yes" and press the **ENTER** button.

The Security function takes effect.

To register a PC card as a protect key.

- 1. Insert a PC card into the PC card slot of the projector.**
- 2. Use the SELECT ▲▼ button to select "Use Protect Key" and press the ENTER button.**
- 3. Use the SELECT ▲▼ button to select "Read" and press the ENTER button.**  
*Data of the PC card will be read into the projector.*
- 4. Use the SELECT ▲▼ button to select "Register" and press the ENTER button.**  
*Downloaded data will be registered and be displayed in the list window.*
- 5. Use the SELECT ▲▼ button to select "Keyword" and use the software keyboard to enter a keyword.**

---

*NOTE: To use a PC card as a protect key, you must also set up a keyword. Please make a note of your keyword.*

---

This completes registration of your PC card.

To enable Security, use the SELECT ▲▼ button to select "Enable" and use the SELECT ▲▼ button to select "OK" and "Security function will be enabled. An "Are you sure?" message will appear. Use the SELECT ◀▶ button and press the ENTER button.

The Security function takes effect.

To turn on the projector when Security is enabled (when using your keyword only).

- 1. Press and hold the POWER button for a minimum of two seconds.**  
*The projector will be turned on and display a message to the effect that the projector is security-protected.*
- 2. Press the MENU button.**  
*The Release Code input screen will be displayed.*
- 3. Enter your keyword in the Release Code input screen.**  
*You can view the projected image.*

---

*NOTE: Do not forget your keyword. However, if you forget your keyword, NEC or your dealer will provide you with your Release Code. See more information at the end of this section.*

---

To turn on the projector when Security is enabled (when using PC card as a protect key).

- 1. Insert your registered PC card into the PC card slot.**
- 2. Press and hold the POWER button for a minimum of two seconds.**  
*The projector will turn on and then recognize the PC card. Once the image has been projected, it will stay on without the PC card.*
  - *The security disable mode is maintained until the main power is turned off (by setting the main power switch to "O" or unplugging the power cord). In the following cases you will be asked to check the protect key or input the keyword:*
    - (1) When "OK" is selected at an image for which security is set and the power is turned off then back on*
    - (2) When the main power is turned off then back on while the security function is enabled*
    - (3) When you attempt to display an image for which security is set while the security function is enabled*
  - *Blanks (spaces) cannot be used in the Keyword section.*

To delete PC card data you registered.

1. Use the **SELECT ▲▼** button to select "Delete" and use the **SELECT ◀** button to select the list window.
2. Use the **SELECT ▲▼** button to select the PC card data you wish to delete.
3. Press the **SELECT ▶** button to select "Delete" and press the **ENTER** button.

The PC card data will be deleted.

If you've lost your registered PC card, proceed as follows:

---

*NOTE: NEC or your dealer will provide you with your Release Code in exchange for your registered keyword and Request Code. See more information at the end of this section.*

---

1. **Press and hold the POWER button for a minimum of two seconds.**  
*The projector will be turned on and display a message to the effect that the projector is security-protected.*
  2. **Press the MENU button.**  
*The Release Code input screen will be displayed as well as your Request Code (24 alphanumeric characters).*
  3. **Enter your Release Code in the Release Code Input screen.**  
*The projector will turn on.*
- \* **If the projector is turned on by entering the Release Code, your Security will be disabled.**

---

*NOTE:*

- *Some types of PC cards cannot be registered as your protect key.*
  - *It is recommended that you register two or more PC cards in case you lose or damage your registered PC card.*
  - *Formatting your registered PC card will disable your protect key function.*
- 

*NOTE:*

*For additional information visit:*

*US : <http://www.necvisualsystems.com>*

*Europe : <http://www.nec-europe.com/>*

*Global : <http://www.nec-pj.com/>*

---



## Installation

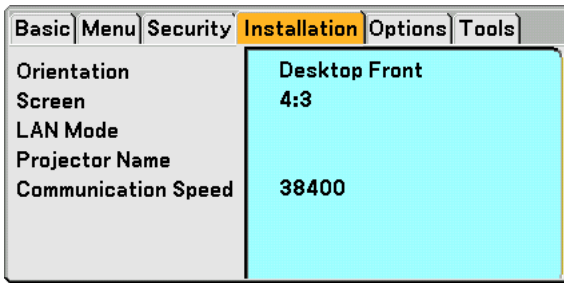

### Selecting Projector Orientation [Orientation]



This reorients your image for your type of projection. The options are: desktop front projection, ceiling rear projection, desktop rear projection, and ceiling front projection.

*NOTE: Selecting one of the other options than "Desktop Front" will force the "Keystone" mode to be "Manual".*

### Selecting Aspect Ratio and Position for Screen [Screen]

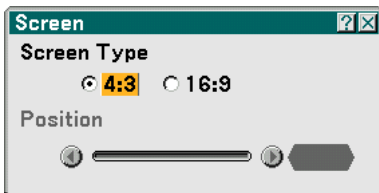

Screen Type ..... Select one of three options: 4:3 Screen or 16:9 Screen for the screen to be used. See also "Aspect Ratio" on page 81.

Position ..... This feature allows you to adjust the vertical position of the image when 16:9 has been selected for the screen type.

When 16:9 has been selected there is black area above and below the image. You can adjust the vertical position of the image in these areas.

You can adjust the vertical position between top and bottom.

*NOTE: This option is available only when "16:9" is selected in Screen Type.*

*NOTE: During 3D Reform adjustment, "Screen Type" and "Screen Position" may not be available. To make available, first reset the 3D Reform data and then do settings again. Secondly repeat the 3D Reform adjustment. Changing "Screen Type" and "Screen Position" can limit 3D Reform in its adjustable range.*

### LAN Mode

#### Setting LAN Mode

This feature allows you to set various setting items when the projector is used on your network.

#### CAUTION

- Consult with your network administrator about these settings.
- Connect a LAN cable (Ethernet cable) to the LAN port (RJ-45). See page 22.
- For wireless LAN connection, use the NEC optional wireless LAN card (NWL-100\*).
  - \* Last digit of the model code varies depending on which country you live in. For more information, visit the above Website.
- To use wireless LAN, insert the NEC optional wireless LAN card (NWL-100\*) into the PC Card slot. See "Inserting and Removing a PC Card" on page 24.
- Always insert or remove the wireless LAN card when the main power is turned off. Failure to do so may cause projector malfunction or damage to the wireless LAN card. If the projector will not work correctly, turn off the projector, wait 90 seconds, and turn it back on.

#### Hints on How to Set Up LAN Connection

To configure the projector to communicate on the network using the LAN port (RJ-45) or the optional wireless LAN card:

1. **Select the "Built-in" tab for the LAN port (RJ-45) or the "PC Card" tab for the optional wireless LAN card.**
2. **On the "Built-in" tab or the "PC Card" tab, select a number from the "Profiles" list for your LAN settings.**  
**Two settings can be stored in memory for each the LAN port and the wireless LAN card respectively.**
3. **On the "Built-in" tab or the "PC Card" tab, turn on or off "DHCP", specify IP address, Subnet Mask, Gateway and DNS Configuration. Select [OK] and press the ENTER button.**  
**See page 100 or 101.**

To recall the settings from memory:

After selecting the "Built-in" tab or the "PC Card" tab, select the number from the "Profiles" list. Select [OK] and press the ENTER button. See page 100 or 101.

To connect a DHCP server:

On the "Built-in" tab or the "PC Card" tab, select "DHCP" and press the ENTER button. A check mark will be placed. Select again and press the ENTER button. The check box will be cleared.

When setting an IP address without using a DHCP server, clear the check box for "DHCP". See page 100 or 101.

To set only for wireless LAN (Network Type and WEP):

1. **On the "PC Card" tab, select "Profiles" and then select "Profile 1" or "Profile 2".**
2. **On the "PC Card" tab, select "Advanced" and press the ENTER button. The "Advanced" menu will be displayed.**  
**See page 102.**

To select a wireless LAN access point:

1. **On the "PC Card" tab, select "Profiles" and then select "Profile 1" or "Profile 2".**
2. **On the "PC Card" tab, select "Advanced" and press the ENTER button.**
3. **On the Advanced menu, select "Network Type" → "Site Survey" and press the ENTER button.**
4. **Select "Mode" and then select "Infrastructure".**  
**See pages 102 and 103.**

To receive error messages or information on the remaining lamp life via e-mail:

1. On the "Mail" tab, select "Alert Mail" and press the ENTER button. A check mark will be placed.
2. Set "Sender's Address", "SMTP Server Name" and "Recipient's Address". Select [OK] and press the ENTER button.

See page 105.

To execute "Easy Connection" using Image Express Utility 2.0:

The "Easy Connection" is a mode that can abbreviate the troublesome LAN settings when using the Image Express Utility 2.0 and connecting the PC and projector via a wireless LAN.

The Image Express Utility 2.0 is contained on the supplied User Supportware 2 CD-ROM. To use "Easy Connection", select "PC Card" → "Profiles" → "Easy Connection". See page 101.

### Built-in

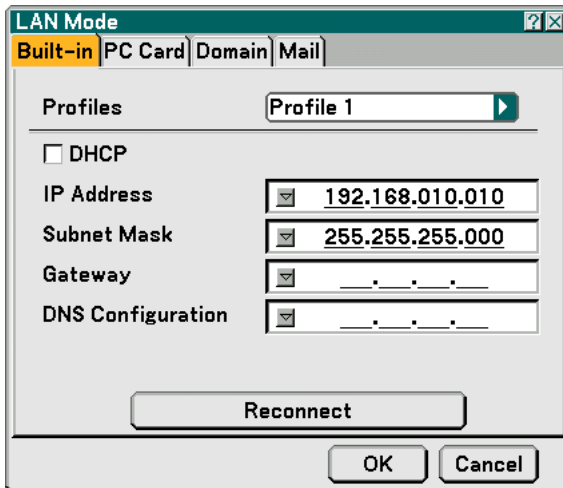

Profiles (for LAN port [RJ-45]):

Up to two settings for the LAN port (RJ-45) can be stored in memory of the projector.

Select "Profile 1" or "Profile 2" and then do settings for "DHCP" and the other options.

After doing this, select [OK] and press the ENTER button. This will store your settings in memory.

DHCP:

Enabling this option automatically assigns an IP address to the projector from your DHCP server.

Disabling this option allows you to register the IP address or subnet mask number obtained from your network administrator.

IP Address ..... Set your IP address. Press  to display the software keyboard and type in 12 numeric characters.

Subnet Mask ..... Set your subnet mask number. Press  to display the software keyboard and type in 12 numeric characters.

Gateway ..... Set the default gateway of the network connected to the projector. Press  to display the software keyboard and type in 12 numeric characters.

DNS Configuration Type in the IP address of DNS server on the network connected to the projector. Twelve numeric characters are used.

Reconnect ..... Use this button to connect the projector to a network.

PC Card

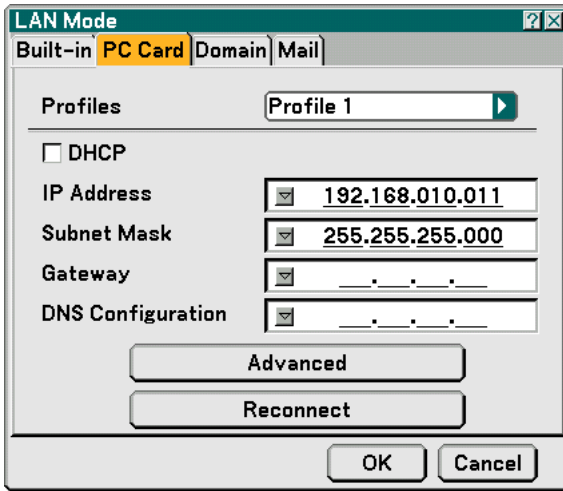

Profiles (for PC Card):

To execute a wireless LAN easily using Image Express Utility 2.0, select "Easy Connection.

Up to two settings for the optional wireless LAN card can be stored in memory of the projector.

Select "Profile 1" or "Profile 2" and then do settings for "DHCP" and the other options.

After doing this, select [OK] and press the ENTER button. This will store your settings in memory.

DHCP:

Place a check mark to automatically assign an IP address to the projector from your DHCP server.

Clear this check box to register the IP address or subnet mask number obtained from your network administrator.

IP Address ..... Set your IP address. Press to display the software keyboard and type in 12 numeric characters.

Subnet Mask ..... Set your subnet mask number. Press to display the software keyboard and type in 12 numeric characters.

Gateway ..... Set the default gateway of the network connected to the projector. Press to display the software keyboard and type in 12 numeric characters.

DNS Configuration Type in the IP address of DNS server on the network connected to the projector. Twelve numeric characters are used.

Advanced ..... Displays the Advanced menu which includes various setting for wireless LAN connection (Network Type and WEP). See the Advanced menu later on.

Reconnect ..... Use this button to connect the projector to a network.

### Advanced menu

#### Network Type (required for wireless only)

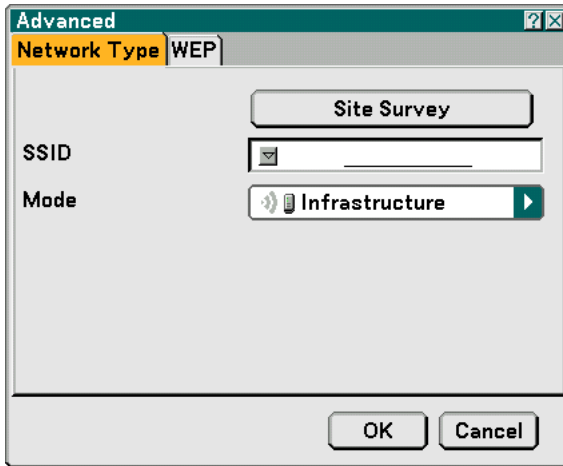

#### Site Survey:

Displays a list of available SSIDs for wireless LAN on site. Select an SSID which you can access.

To select an SSID, highlight the SSID and use the SELECT ► to select [OK] and press the ENTER button.

- 📶 : access point
- 📶🖥️ : Ad Hoc PC
- 🔑 : WEP enabled

NOTE: You cannot connect to a device with the SSID for Channel 14 because it is not displayed in the list.

#### SSID (Network name):

Enter an identifier (SSID) for wireless LAN when selecting [Infrastructure] or [802.11 Ad Hoc] in [Mode]. Communication can be done only with equipment whose SSID matches SSID for your wireless LAN. Up to 32 alphanumeric characters can be used.

---

NOTE: To disable SSID, select a space (null) or "ANY"(All caps).

---

#### Mode:

Select communication method when using wireless LAN.

Infrastructure ..... Select this option when communicating with one or more equipment connected to the wireless or wired LAN network via an access point.

802.11 Ad Hoc ..... Select this option when using the wireless LAN to directly communicate with a computer in peer-to-peer mode. This is a method that meets the IEEE802.11 wireless standard.

---

NOTE: When in Ad Hoc mode, only 802.11b is available for communication method.  
Data transmission speed in Ad Hoc mode is limited up to 11Mbps.

---

WEP (required for wireless only)

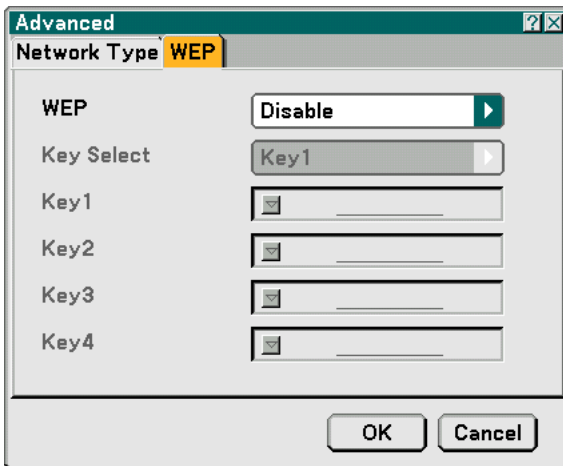

Select this option whether using the WEP (Wired Equivalent Privacy) key for encryption or not. To use encryption, specify WEP key.

Disable ..... Will not turn on the encryption feature. Your communications may be monitored by someone.

64bit ..... Uses 64-bit datalength for secure transmission.

128bit ..... Uses 128-bit datalength for secure transmission. This option will increase privacy and security when compared to use of 64-bit datalength encryption.

152bit ..... Uses 152-bit datalength for secure transmission. This option will increase privacy and security when compared to use of 128-bit datalength encryption.

**NOTE:**

- The WEP settings must be the same as communication devices such as PC or access point in your wireless network.
- When you use WEP, your image transmission speed will slow down.

**Key Select:**

Selects one key from the four keys below when selecting [64bit], [128bit] or [152bit] in [WEP].

**Key1-4:**

Enter encryption key when selecting [64bit], [128bit] or [152bit] in [WEP].

Up to 5 characters can be set in 64 bit, up to 13 characters in 128 bit and up to 16 characters in 152 bit. Press the "HEX" button to change to "ASCII" to set the key in ASCII digit. You can toggle this button between "ASCII" and "HEX".

The key can also be set in hexadecimal digit.

\* Enter 0X(numeral and alphabet respectively) right in front of your key code.

\* Hexadecimal uses 0 to 9 and A to F.

\* When setting in a hexadecimal digit, up to 10 characters can be set in 64 bit, up to 26 characters in 128 bit and up to 32 characters in 152 bit.

### Using Software Keyboard to enter an encryption key

1. Select one of Key 1, Key 2, Key 3 and Key 4 and press the ENTER button.  
The software keyboard will be displayed.

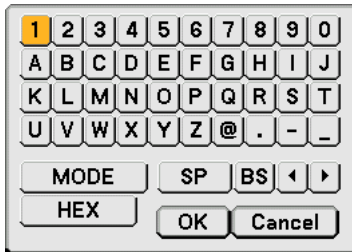

2. Use the SELECT ▲▼◀▶ button to select one key and press the ENTER button.
3. After finishing entering the WEP key, use the SELECT ▲▼◀▶ button to select [OK] and press the ENTER button.  
The software keyboard will disappear.

### Domain

A dialog box titled "LAN Mode" with a tabbed interface. The tabs are "Built-in", "PC Card", "Domain", and "Mail", with "Domain" selected. Inside the dialog, there are two input fields: "Host Name" and "Domain Name", each with a dropdown arrow on the left. At the bottom of the dialog are "OK" and "Cancel" buttons.

Host Name ..... Type in a hostname. Up to 60 alphanumeric characters can be used.

Domain Name ..... Type in domain name of the network connected to the projector. Up to 60 alphanumeric characters can be used.

## Mail

The screenshot shows a window titled "LAN Mode" with a tabbed interface. The "Mail" tab is active. The window contains the following elements:

- Alert Mail
- Sender's Address: [input field]
- SMTP Server Name: [input field]
- Recipient's Address 1: [input field]
- Recipient's Address 2: [input field]
- Recipient's Address 3: [input field]
- Test Mail: [button]
- OK: [button]
- Cancel: [button]

## Alert Mail:

Checking this box enables Alert Mail feature.

This option notifies your computer of an error message via e-mail when using wireless or wired LAN. The error message will be notified when the projector lamp has reached the end of its usable life or an error occurs in the projector.

Sample of a message sent from the projector:

The lamp is at the end of its usable life. Please replace the lamp.

*Projector Name: X X X X*

*Lamp Hour Meter: xxxx [H]*

*Projector Usage: xxxxxx [H]*

## Sender's Address:

Specify the senders address. Use the Software keyboard. Up to 60 alphanumeric and symbols characters can be used. See "Using Software Keyboard" in Appendix for more details.

## SMTP Server Name:

Type in the SMTP server name to be connected to the projector. Up to 60 alphanumeric characters can be used.

## Recipient's Address 1 to 3:

Type in your recipient's address. Up to 60 alphanumeric and symbols characters can be used.

## Test Mail:

Send a test mail to check if your settings are correct.

**NOTE:**

- If you entered an incorrect address in a test, you may not receive an Alert mail. Should this happen, check if the Recipient's Address is correctly set.
- Unless any one of the "Sender's Address", "SMTP Server's Name" or "Recipient's Address 1-3" is selected, "Test Mail" is not available.
- Be sure to highlight "OK" and press the ENTER button before executing "Test Mail".

**NOTE:** To use the Mail Alert feature on wireless LAN connection, select "Infrastructure" for "Mode" in "Network Type."



**Projector Name**

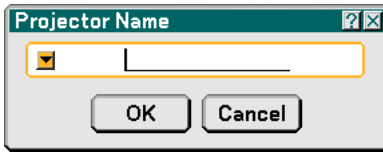

Specify a unique projector name. Press  to display the software keyboard and type in. Up to 16 alphanumeric characters can be used. After entering a name, select [OK] and press the ENTER button.

**Using Software Keyboard**

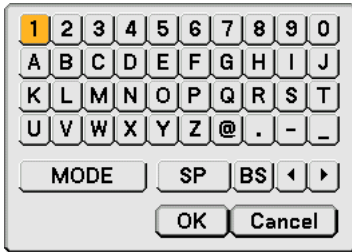

- 1 to 0 and Characters ..... Use to type in password or keyword.
- MODE ..... Selects one of three modes for alphabet and special characters.
- SP ..... Inserts a space
- BS ..... Deletes one character backward  
Returns to the previous  
Advances to the next
- OK ..... Executes the selection
- Cancel ..... Cancels the selection

**Selecting Communication Speed [Communication Speed]**

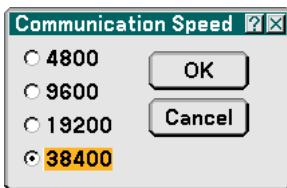

This feature sets the baud rate of the PC Control port (Mini DIN 8 Pin). It supports data rates from 4800 to 38400 bps. The default is 38400 bps. Select the appropriate baud rate for your equipment to be connected (depending on the equipment, a lower baud rate may be recommended for long cable runs).

## Options

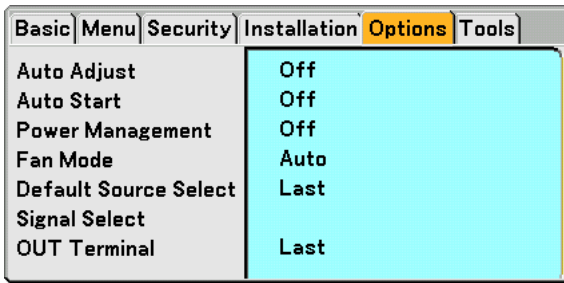

### Setting Auto Adjust [Auto Adjust]

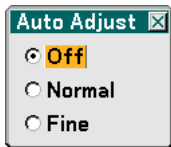

This feature sets the Auto Adjust mode so that the RGB image can be automatically or manually adjusted for noise and stability. You can automatically make adjustment in two ways: Normal and Fine.

Off ..... The RGB image will not be automatically adjusted.  
You can manually optimize the RGB image.

Normal ..... Default setting. The RGB image will be automatically adjusted. Normally select this option.

Fine ..... Select this option if fine adjustment is needed. It takes more time to switch to the source than when "Normal" is selected.

### Enabling Auto Start [Auto Start]



Turns the projector on automatically when the power cable is inserted into an active power outlet and the main power switch is turned on. This eliminates the need to always use the "Power" button on the remote control or projector cabinet.

### Enabling Power Management [Power Management]



When this option is on and there is no input for five minutes or more, the projector will automatically turn itself off.

### Enabling High Speed Fan Mode [Fan Mode]



This option allows you to select two modes for fan speed: Auto mode and High speed mode.

Auto ..... The built-in fans automatically run at a variable speed according to the internal temperature.

High ..... The built-in fans run at high speed.

When you wish to cool down the temperature inside the projector quickly, select “High”.

---

*NOTE: Select High mode if you continue to use the projector for consecutive days.*

---

### Selecting Default Source [Default Source Select]:



You can set the projector to default to any one of its inputs each time the projector is turned on.

Last ..... Sets the projector to default to the previous or last active input each time the projector is turned on.

Auto ..... Searches for an active source in order of Computer1 → Computer2 → Video → S-Video → Viewer → LAN → Computer1 and displays the first found source.

Select ..... Displays the selected source input every time the projector is started up. Select an input from the pull-down menu.

**Selecting Signal Format [Signal Select]**

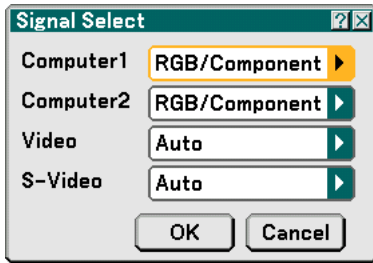

**Computer 1/2**

Allows you to set "Computer 1" and "Computer 2" to automatically detect an incoming RGB or component source such as a computer or DVD player. However there may be some RGB and component signals that the projector is unable to detect. In this case, select "RGB" or "Component".  
Select "Scart" in COMPUTER 1 for the European Scart signal.

**Video and S-Video**

This feature enables you to select video standards manually.  
Normally select "Auto". Select the video standard from the pulldown menu. This must be done for Video and S-Video separately.

**Setting MONITOR OUT Connector [OUT Terminal]**

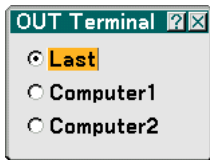

This option allows you to determine which RGB or component source is output from the MONITOR OUT connector during Standby mode.

- Last ..... The signal from the last COMPUTER1 or 2 input will be output to the MONITOR OUT connector.
- COMPUTER 1, 2 .... The signal from the COMPUTER1 or 2 input will be output to the MONITOR OUT connector.

## Tools

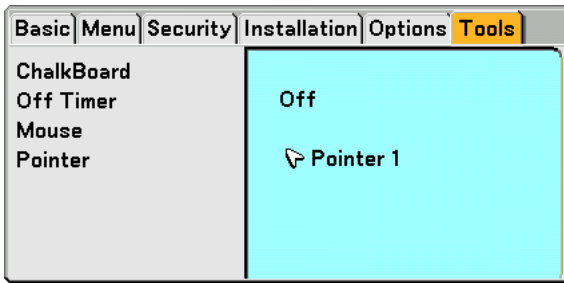

### Selecting the ChalkBoard [ChalkBoard]



This option displays the ChalkBoard tool bar.

The ChalkBoard feature allows you to write and draw messages on a projected image.

*NOTE: The ChalkBoard feature is available only when a USB mouse is used.*

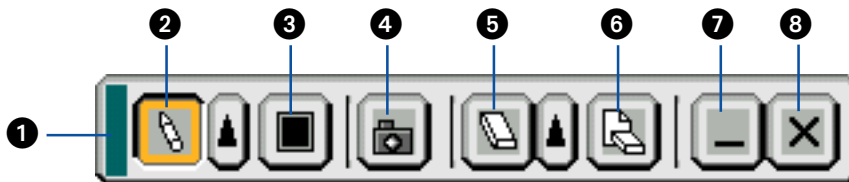
To display or hide the ChalkBoard tool bar, click the middle button on your mouse. The tool bar contains the following icons.



- ❶ Drag ..... Drags to move the tool bar.
- ❷ Pen ..... Left-click and drag to draw. Left-click  or right-click the pen icon to display the pen palette containing four lines of different thickness from which you can select a line you prefer by left-clicking.
- ❸ Color ..... Selects a color. Left-click to display the color palette from which you can select a color you prefer by left-clicking.
- ❹ Capture ..... Left-click to capture a drawing on the ChalkBoard screen and save it to your PC-card inserted into the PC card slot of the projector.
- ❺ Eraser ..... Left-click and drag to erase part of a drawing. Left-click  or right-click the eraser icon to display the eraser palette containing four eraser of different thickness from which you can select an eraser you prefer by left-clicking.
- ❻ Clear ..... Left-click to clear the drawing completely from the ChalkBoard screen.
- ❼ Hide ..... Hides the tool bar by left-clicking. Right-clicking anywhere on the screen displays the ChalkBoard tool bar again.
- ❽ Exit ..... Clears the complete drawing and exits the ChalkBoard.

#### NOTE:

- The menu is not available while you display the ChalkBoard screen.
- Selecting another source or switching slides in the Viewer clears a drawing completely.

Using Off Timer [Off Timer]

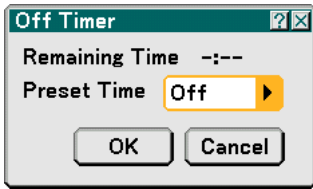

1. Select your desired time between 30 minutes and 16 hours: Off, 0:30, 1:00, 2:00, 4:00, 8:00, 12:00, 16:00.
2. Select "OK" and press the ENTER button on the remote control.
3. The remaining time starts counting down.
4. The projector will turn off after the countdown is complete.

NOTE:

- To cancel the preset time, set "Off" for the preset time or turn off the power.
- When the remaining time reaches 3 minutes before the projector is turned off, the "Projector will turn off in 3 minutes" message will be displayed on the bottom of the screen.

Setting Mouse Pointer, Button and Sensitivity [Mouse]

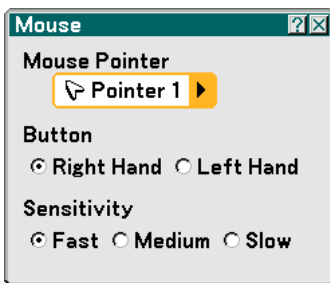

This option lets you to change your USB mouse settings. The mouse settings feature is available for USB mouse only. Choose the settings you want:

- Mouse Pointer ..... Pointer 1 - 9
- Mouse Button ..... "Right Hand" or "Left Hand"
- Mouse Sensitivity .. "Fast", "Medium" or "Slow"

Selecting Projecting Pointer Icon [Pointer]

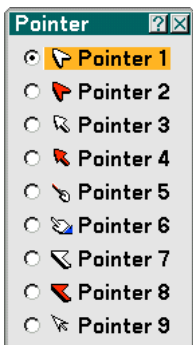

This enables you to select from nine different Pointer icons for the "POINTER" button on your remote control. After moving your Pointer icon to the area you want on the screen, press the MAGNIFY button on the remote control to enlarge the selected area on the screen. See page 40 for more details.

NOTE: There may be cases where the Pointer function is not available (ex. A non-interlace signal at 15kHz such as video game.)

## 7 Menu Descriptions & Functions [Information]

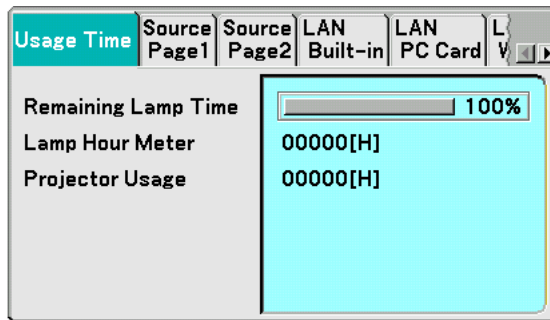

Displays the lamp and the projector usage hours, the status of the current signal and settings and LAN settings. This dialog box has seven pages.

The information included are as follows:

### Usage Time

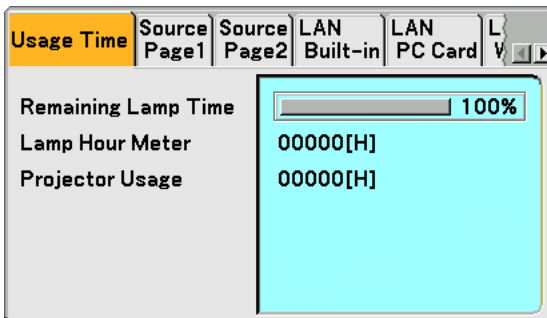

Remaining Lamp Time (%)

Lamp Hour Meter (H)

Projector Usage (H)

---

*NOTE: The progress indicator shows the percentage of remaining lamp life. The value informs you of the amount of lamp and projector usage respectively.*

---

**Source Page1**

Usage Time	Source Page1	Source Page2	LAN Built-in	LAN PC Card	L V
Input Terminal	Video				
Signal Type	Video				
Video Type	NTSC3.58				
Source Name	NTSC3.58				
Entry No.	3				

Input Terminal                      Signal Type  
 Video Type                          Source Name  
 Entry No.

**Source Page2**

Usage Time	Source Page1	Source Page2	LAN Built-in	LAN PC Card	L V
Horizontal Frequency	15.73[kHz]				
Vertical Frequency	59.93[Hz]				
Sync Type	---				
Sync Polarity	---				
Interlace	Non-Interlace				

Horizontal Frequency              Vertical Frequency  
 Sync Type                              Sync Polarity  
 Interlace



**LAN Built-in**

Usage Time	Source Page1	Source Page2	LAN Built-in	LAN PC Card	L V
IP Address	192.168. 10. 10				
Subnet Mask	255.255.255. 0				
Gateway	. . .				
MAC Address	00-02-78-E0-8C-B4				

This page shows information on settings for the LAN port (RJ-45)

- IP Address ..... Indicates the IP address of the projector when the LAN port (RJ-45) is used.
- Subnet Mask ..... Indicates the subnet mask of the projector when the LAN port (RJ-45) is used
- Gateway ..... Indicates the gateway of the network connected to the projector when the LAN port (RJ-45) is used.
- MAC Address ..... Indicates the MAC address of the LAN port (RJ-45).

**LAN PC Card**

Usage Time	Source Page1	Source Page2	LAN Built-in	LAN PC Card	L V
IP Address	192.168. 10. 11				
Subnet Mask	255.255.255. 0				
Gateway	. . .				
MAC Address	00-02-78-E0-8C-B4				

This page shows information on settings for the optional wireless LAN card

- IP Address ..... Indicates the IP address of the projector when the optional wireless LAN card is used.
- Subnet Mask ..... Indicates the subnet mask of the projector when the optional wireless LAN card is used.
- Gateway ..... Indicates the gateway of the network connected to the projector when the optional wireless LAN card is used.
- MAC Address ..... Indicates the MAC address of the optional wireless LAN card.

**LAN Wireless**

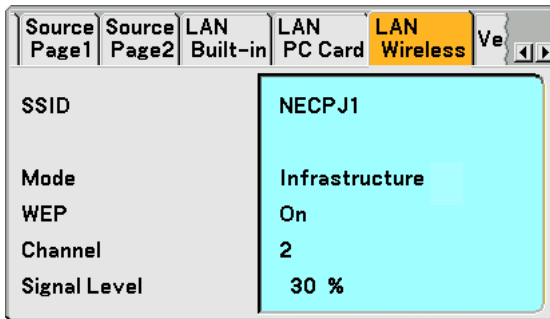

This page shows information on settings for WEP key for encryption.

- SSID ..... Indicates the identifier (SSID) for your wireless LAN.
- Mode ..... Indicates that "Infrastructure" or "802.11 Ad Hoc" is selected for your communication method
- WEP ..... Indicates your selected datalength encryption: On or Off
- Channel ..... Indicates the channel you selected in the Site Survey. The channel must match for all wireless devices communicating on your wireless LAN.
- Signal Level ..... Indicates receiving condition of radio signal level while you are using a wireless LAN connection (Only when PC Card is used)

**Version**

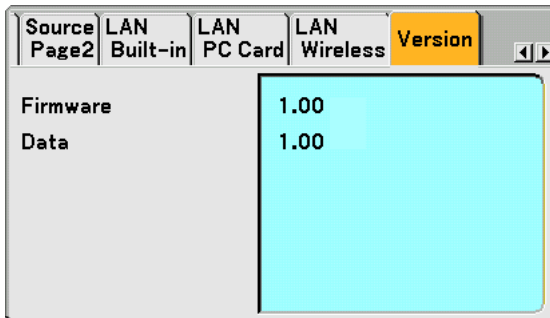

Firmware  
Data

## 8 Menu Descriptions & Functions [Reset]



### Returning to Factory Default

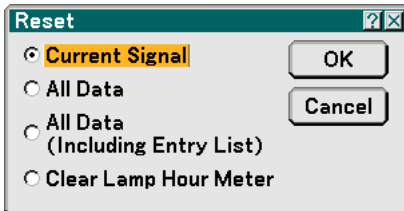

The Reset feature allows you to change adjustments and settings to the factory preset for sources by the following methods:

#### [Current Signal]

Resets the adjustments for the current signal to the factory preset levels.  
All the items in “Adjust (except “Wall Color”) can be reset.

#### [All Data]

Reset all the adjustments and settings for all the signals to the factory preset except Entry List, Language, Background, Cabinet Button Lock, Password (Menu), Password (Logo), Security, LAN Mode, Projector Name, Communication, Remaining Lamp Time, Lamp Hour Meter and Projector Usage.

#### [All Data (Including Entry List)]

Reset all the adjustments and settings for all the signals to the factory preset except Language, Background, Cabinet Button Lock, Password (Menu), Password (Logo), Security, LAN Mode, Projector Name, Communication, Remaining Lamp Time, Lamp Hour Meter and Projector Usage.

Also deletes all the signals in the Entry List and returns to the factory preset.

---

*NOTE: Locked signals in Entry List cannot be reset.*

---

#### Clearing Lamp Hour Meter [Clear Lamp Hour Meter]

Resets the lamp clock back to zero.

---

*NOTE: The projector will turn off and go into standby mode after 2100 hours (up to 4100 hours in Eco mode) of service. In this condition you cannot clear the lamp hour meter on the menu. If this happens, press the “HELP” button on the remote control for ten seconds to reset the lamp clock back to zero. Do this only after replacing the lamp.*

---

# 7

## ***Maintenance***

.....

①	Cleaning the Cabinet .....	118
②	Cleaning the Lens .....	118
③	Replacing the Lamp .....	119

This section describes the simple maintenance procedures you should follow to replace the lamp, and to clean the cabinet and the lens.

### ① Cleaning the Cabinet

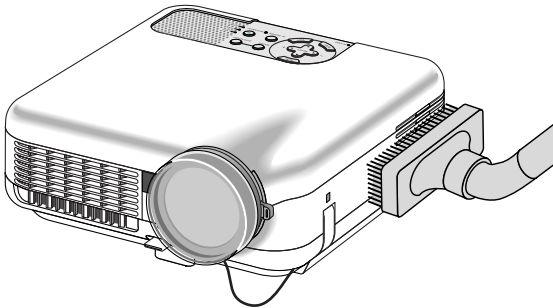

1. Turn off the projector before cleaning.
2. Clean the cabinet periodically with a damp cloth. If heavily soiled, use a mild detergent. Never use strong detergents or solvents such as alcohol or thinner.

### ② Cleaning the Lens

Use a blower or lens paper to clean the lens, and be careful not to scratch the lens.

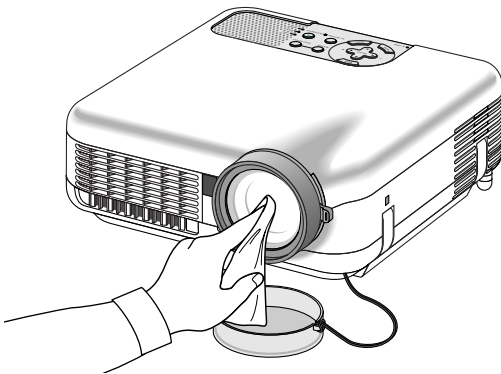

### Lens Protector

The lens barrel has threads on the outside for mounting a commercially available step-up ring ( $\phi 77\text{mm} \rightarrow \phi 82\text{mm}$ ) and lens protector ( $\phi 82\text{mm}$ ) to protect the lens from dirt, dust, scratches and damage. Note that both a lens protector and the supplied lens cap cannot be used at the same time.

**CAUTION:** Use only transparent lens protectors designed for lens protection. Use of filters for light reduction and special effects, such as ND (Neutral Density) filters and color filters, can absorb heat, resulting in damage to the filter and the projector.

### ③ Replacing the Lamp

After your lamp has been operating for 2000 hours (up to 4000 hours : Eco mode) or longer, the "Lamp" indicator in the cabinet will blink red and the message will appear. Even though the lamp may still be working, replace it at 2000 hours (up to 4000 hours : Eco mode) to maintain optimal projector performance.

#### CAUTION

- DO NOT TOUCH THE LAMP immediately after it has been used. It will be extremely hot. Turn the projector off, wait 90 seconds, turn off the main power switch, and then disconnect the power cable. Allow at least one hour for the lamp to cool before handling.
- DO NOT REMOVE ANY SCREWS except the lamp cover screw and two lamp case screws. You could receive an electric shock.
- Do not break the glass on the lamp housing. Keep finger prints off the glass surface on the lamp housing. Leaving finger prints in the glass surface might cause an unwanted shadow and poor picture quality.
- The projector will turn off and go into stand by mode after 2100 hours (up to 4100 hours : Eco mode) of service. If this happens, be sure to replace the lamp. If you continue to use the lamp after 2000 hours (up to 4000 hours : Eco mode) of use, the lamp bulb may shatter, and pieces of glass may be scattered in the lamp housing. Do not touch them as the pieces of glass may cause injury.  
If this happens, contact your NEC dealer for lamp replacement.

#### To replace the lamp:

1. **Loosen the lamp cover screw until the screwdriver goes into a freewheeling condition and remove the lamp cover. The lamp cover screw is not removable.**

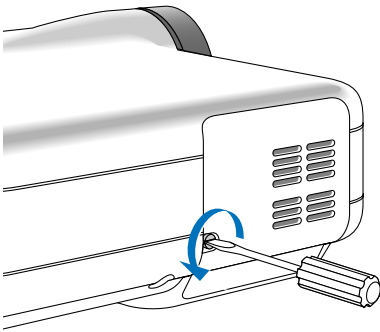

2. **Loosen the two screws securing the lamp housing until the screwdriver goes into a freewheeling condition. The two screws are not removable.**

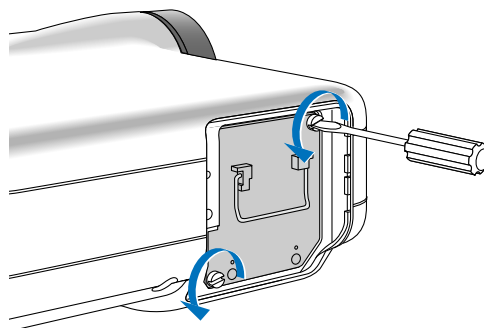
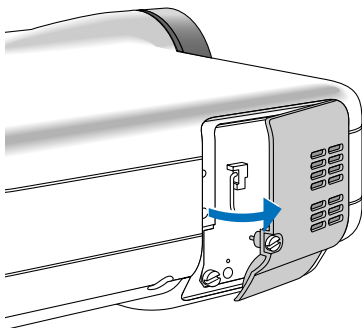

### 3. Remove the lamp housing by pulling out the handle.

*NOTE: There is an interlock on this case to prevent the risk of electrical shock. Do not attempt to circumvent this interlock.*

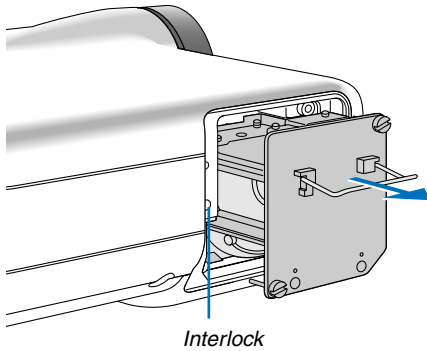

### 4. Insert a new lamp housing until the lamp housing is plugged into the socket.

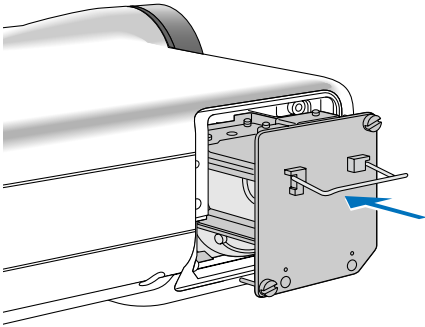

### CAUTION

Do not use a lamp other than the NEC replacement lamp (LT60LPK).

### 5. Secure it in place with the two screws.

***Be sure to tighten the screws.***

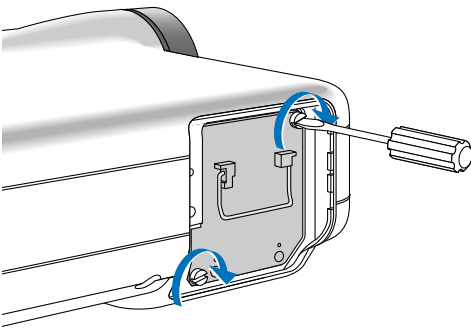

### 6. Reattach the lamp cover.

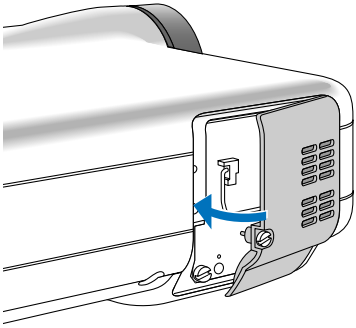

### 7. Tighten the lamp cover screw.

**Be sure to tighten the screw.**

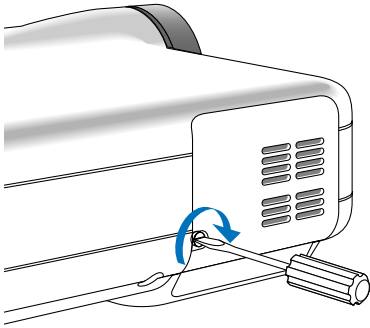

### 8. After you install a new lamp, select the menu [Reset] → [Clear Lamp Hour Meter] to clear the Remaining Lamp Time and the Lamp Hour Meter.

---

*NOTE: When the lamp exceeds 2100 hours (up to 4100 hours in Eco mode) of service, the projector cannot turn on and the menu is not displayed. If this happens, press the HELP button on the remote control for a minimum of 10 seconds while in standby mode. When the lamp time clock is reset to zero, the LAMP indicator goes out.*

---



# 8

## ***Appendix***

.....

①	Troubleshooting .....	123
②	Specifications .....	126
③	Cabinet Dimensions .....	128
④	Pin Assignments of D-Sub COMPUTER 1/2 Input Connector .....	129
⑤	Compatible Input Signal List .....	130
⑥	PC Control Codes and Cable Connection .....	131
⑦	Using Software Keyboard .....	132
⑧	Troubleshooting Check List .....	133
⑨	TravelCare Guide .....	135

## 1 Troubleshooting

This section helps you resolve problems you may encounter while setting up or using the projector.

### Indicator Messages

#### Power Indicator

Indicator Condition			Projector Condition	Note
Off			The main power is off	–
Blinking light	Green	0.5 sec On, 0.5 sec Off	The projector is getting ready to turn on.	Wait for a moment.
		2.5 sec On, 0.5 sec Off	Off Timer is activated.	–
	Orange	0.5 sec On, 0.5 sec Off	The projector is cooling down.	Wait for a moment.
Steady light	Green		The projector is turned on.	–
	Orange		The projector is in Standby.	–

#### Status Indicator

Indicator Condition			Projector Condition	Note
Off			Normal	–
Blinking light	Red	1 cycle (0.5 sec On, 2.5 sec Off)	Lamp cover error	Replace the lamp cover correctly. (Page 121)
		2 cycle (0.5 sec On, 0.5 sec Of)	Temperature error	The projector is overheated. Move the projector to a cooler location.
		3 cycle (0.5 sec On, 0.5 sec Off)	Power error	Power unit will not work correctly.
		4 cycle (0.5 sec On, 0.5 sec Off)	Fan error	Fans will not work correctly.
		6 cycle (0.5 sec On, 0.5 sec Off)	Lamp error	Lamp fails to light. Wait a full minute and then turn on again.
	Green		Re-firing the lamp	The projector is re-firing.
	Orange	1 cycle(0.5 sec On, 2.5 sec Off)	Network conflict	Both the built-in LAN and the wireless LAN cannot be connected to the same network at the same time. To use both built-in LAN and wireless LAN at the same time, connect them to different networks. (page 100)
Steady light	Orange		Cabinet button is locked	You have pressed cabinet button when Cabinet Button is locked. (Page 93)

#### Lamp Indicator

Indicator Condition			Projector Condition	Note
Off			Normal	–
Blinking light	Red		Lamp has reached its end of life. Lamp replacement message will be displayed.	Replace the lamp. (Page 119)
Steady light	Red		Lamp has been used beyond its limit. The projector will not turn on until the lamp is replaced.	Replace the lamp. (Page 119)
	Green		Lamp mode is set to Eco mode	–

**Common Problems & Solutions** (See also "Power/Status/Lamp Indicator" on page 123.)

Problem	Check These Items
Does not turn on	<ul style="list-style-type: none"> <li>• Check that the power cable is plugged in and that the power button on the projector cabinet or the remote control is on. See pages 26 and 28.</li> <li>• Ensure that the lamp cover is installed correctly. See page 121.</li> <li>• Check to see if the projector has overheated or the lamp usage exceeds 2100 hours (up to 4100 hours : Eco mode). If there is insufficient ventilation around the projector or if the room where you're presenting is particularly warm, move the projector to a cooler location.</li> <li>• The lamp may fail to light. Wait a full minute and then turn on the power again.</li> <li>• The lamp has reached the end of its usable life. Replace the lamp.</li> </ul>
Will turn off	<ul style="list-style-type: none"> <li>• Ensure that the Power Management is off. See page 107.</li> </ul>
No picture	<ul style="list-style-type: none"> <li>• Use the SOURCE button on the projector cabinet or the VIDEO, the S-VIDEO, the COMPUTER 1/2, the VIEWER or the LAN button on the remote control to select your source. See page 30.</li> <li>• Ensure your cables are connected properly.</li> <li>• Use menus to adjust the brightness and contrast. See page 79.</li> <li>• Remove the lens cap.</li> <li>• Reset the settings or adjustments to factory preset levels using the Reset in the Menu. See page 116.</li> <li>• Enter your registered keyword if the Security function is enabled. See page 48.</li> <li>• When using with a notebook PC, be sure to connect between the projector and the notebook PC before turning on the power to the notebook PC. In most cases signal cannot be output from RGB output unless the notebook PC is turned on after connecting with the projector. <ul style="list-style-type: none"> <li>* If the screen goes blank while using your remote control, it may be the result of the computer's screen-saver or power management software.</li> <li>* If you accidentally hit the POWER button on the remote control, wait 90 seconds and then press the POWER button again to resume.</li> </ul> </li> <li>• See also the next page.</li> </ul>
Color tone or hue is unusual	<ul style="list-style-type: none"> <li>• Check if an appropriate color is selected in "Wall Color". If so, select an appropriate option. See page 80.</li> <li>• Adjust "Hue" in "Adjust". See page 80.</li> </ul>
Image isn't square to the screen	<ul style="list-style-type: none"> <li>• Reposition the projector to improve its angle to the screen. See page 31.</li> <li>• Use the 3DReform function to correct the trapezoid distortion. See page 33.</li> </ul>
Picture is blurred	<ul style="list-style-type: none"> <li>• Adjust the focus. See page 32.</li> <li>• Reposition the projector to improve its angle to the screen. See page 31.</li> <li>• Ensure that the distance between the projector and screen is within the adjustment range of the lens. See page 15.</li> <li>• Condensation may form on the lens if the projector is cold, brought into a warm place and is then turned on. Should this happen, let the projector stand until there is no condensation on the lens.</li> </ul>
Image is scrolling vertically, horizontally or both	<ul style="list-style-type: none"> <li>• Use the SOURCE button on the projector cabinet or the VIDEO, the S-VIDEO, the COMPUTER 1/2, the VIEWER or the LAN button on the remote control to select your source (Video, S-Video, Computer, Viewer or LAN). See page 30.</li> <li>• Adjust the computer image manually with the "Clock"/"Phase" in "Adjust" → "Image Options". See page 86.</li> </ul>
Remote control does not work	<ul style="list-style-type: none"> <li>• Install new batteries. See page 12.</li> <li>• Make sure there are no obstacles between you and the projector.</li> <li>• Stand within 22 feet (7 m) of the projector. See page 12.</li> </ul>
Indicator is lit or blinking	<ul style="list-style-type: none"> <li>• See the POWER/STATUS/LAMP Indicator on page 123.</li> </ul>
Vertical stripes in RGB mode	<ul style="list-style-type: none"> <li>• Press the AUTO ADJUST button on the projector cabinet or the AUTO ADJ. button on the remote control. See page 35.</li> <li>• Adjust the computer image manually with the "Clock"/"Phase" in "Adjust" → "Image Options". See page 86.</li> </ul>
USB mouse does not work	<ul style="list-style-type: none"> <li>• Make sure that your USB mouse is properly connected to the projector. The projector may not support some brands of a USB mouse.</li> </ul>
Capture function is not possible.	<ul style="list-style-type: none"> <li>• The Capture function is not available on LAN. See page 30.</li> </ul>

For more information contact your dealer.

**If there is no picture, or the picture is not displayed correctly.**

- Power on process for the projector and the PC.

Be sure to connect the RGB cable between the projector and the computer before turning on the computer. There are some notebook PCs, which do not output signal unless there is a projector or monitor connected first.

---

*NOTE: You can check the horizontal frequency of the current signal in the projector's menu under Information. If it reads "0kHz", this means there is no signal being output from the computer. See page 113 or go to next step.*

---

- Enabling the computer's external display.

Displaying an image on the notebook PC's screen does not necessarily mean it outputs a signal to the projector. When using a PC compatible laptop, a combination of function keys will enable/disable the external display. Usually, the combination of the 'Fn' key along with one of the 12 function keys gets the external display to come on or off. For example, NEC laptops use Fn + F3, while Dell laptops use Fn + F8 key combinations to toggle through external display selections.

- Non-standard signal output from the computer

If the output signal from a notebook PC is not an industry standard, the projected image may not be displayed correctly. Should this happen, deactivate the notebook PC's LCD screen when the projector display is in use. Each notebook PC has a different way of deactivate/reactivate the local LCD screens as described in the previous step. Refer to your computer's documentation for detailed information.

- Image displayed is incorrect when using a Macintosh

When using a Macintosh with the projector, set the DIPswitch of the Mac adapter (not supplied with the projector) according to your resolution. After setting, restart your Macintosh for the changes to take affect.

For setting display modes other than those supported by your Macintosh and the projector, changing the DIP switch on a Mac adapter may bounce an image slightly or may display nothing. Should this happen, set the DIP switch to the 13" fixed mode and then restart your Macintosh. After that, restore the DIP switches to a displayable mode and then restart the Macintosh again.

---

*NOTE: A Video Adapter cable manufactured by Apple Computer is needed for a PowerBook which does not have a mini D-Sub 15-pin connector.*

---

- Mirroring on a PowerBook

- \* When using the projector with a Macintosh PowerBook, output may not be set to 1024 x 768 unless "mirroring" is off on your PowerBook. Refer to owner's manual supplied with your Macintosh computer for mirroring.

- Folders or icons are hidden on the Macintosh screen

Folders or icons may not be seen on the screen. Should this happen, select [View] ->[Arrange] from the Apple menu and arrange icons.

## ② Specifications

This section provides technical information about the LT265/LT245 Projector's performance.

Model Number	LT265/LT245
<b>Optical</b>	
DMD™	Single Chip Digital Micromirror Device (DMD™)
Resolution	1024 × 768 pixels* up to UXGA with Advanced AccuBlend
Lens	Manual zoom and focus: LT265: F2.1 - 2.3 f=28.2mm - 33.6mm LT245: F2.2 - 2.5 f=22.1mm - 26.5mm
Lamp	220 W DC standard
Image Size	30 inches - 500 inches (0.8 m - 12.7 m) diagonal
Projection Distance	LT265: 3.8ft - 80.7ft / 1.20m - 24.5m LT245: 2.95ft - 62.3ft / 0.90m - 19.1m
Projection Angle	LT265: 14.8°-15.4°(wide) / 12.3°-12.7°(tele) LT245: 18.5°-19.4°(wide) / 15.6°-16.2°(tele)
<b>Electrical</b>	
Inputs	2 RGB (Mini D-Sub 15p), 1 S-Video (Mini DIN 4p), 1 Video, 1 PC Card, 1 Stereo Mini Audio, 1 (L/R) RCA Audio, 1 PC Control (Mini DIN 8p)
Outputs	1 RGB (Mini D-Sub 15p), 1 Stereo Mini Audio
USB Port	1 A Type
LAN Port	RJ-45
Video Compatibility	NTSC, NTSC4.43, PAL, PAL-60, PAL-N, PAL-M, SECAM, 1080i, 720p, 576p, 576i, 480p, 480i (w/optional cable)
Scan Rate	Horizontal: 15 kHz to 100 kHz (RGB: 24 kHz or over) Vertical: 48 Hz to 120 Hz
Video Bandwidth	RGB: 100 MHz (-3dB)
Pixel Clock Freq	Less than 135 MHz
Color Reproduction	16.7 million colors simultaneously, Full color
Horizontal Resolution	NTSC / NTSC4.43/PAL / YCbCr: 540 TV lines SECAM: 300 TV lines RGB: 1024 dots (H) × 768 dots (V)
External Control	RS232, IR, LAN, USB
Sync Compatibility	Separate Sync / Composite Sync / Sync on G
Built-in Speakers	2W × 1 (monaural)
Power Requirement	100 - 240V AC, 50/60Hz
Input Current	3.1 - 1.4A
Power Consumption	290W in Lamp Normal mode 240W in Lamp Eco mode 12W in Standby mode

\* Effective pixels are more than 99.99%.

**Mechanical**

Installation	Orientation: Desktop/Front, Desktop/Rear, Ceiling/Front, Ceiling/Rear
Dimensions	10.2" (W) × 3.6" (H) × 10.8" (D) 260mm (W) × 92mm (H) × 275mm (D) (not including protrusions)
Net Weight	LT265: 6.5 lbs / 2.9 kg LT245: 7.1 lbs / 3.2 kg
Environmental Considerations	
Operational Temperatures :	41° to 95°F (5° to 35°C), 20% to 80% humidity (non-condensing)
Storage Temperatures :	14° to 122°F (-10° to 50°C), 20% to 80% humidity (non-condensing)
Regulations	UL Approved (UL 60950, CSA 60950) Meets DOC Canada Class B requirements Meets FCC Class B requirements Meets AS/NZS CISPR.22 Class B Meets EMC Directive (EN55022, EN55024, EN61000-3-2, EN61000-3-3) Meets Low Voltage Directive (EN60950, TÜV GS Approved)



For additional information visit:

US : <http://www.necvisualsystems.com>

Europe : <http://www.neceurope.com/>

Global : <http://www.nec-pj.com/>

Digital Light Processing, DLP, Digital Micromirror Device and DMD are trademarks of Texas Instruments. The specifications are subject to change without notice.

### 3 Cabinet Dimensions

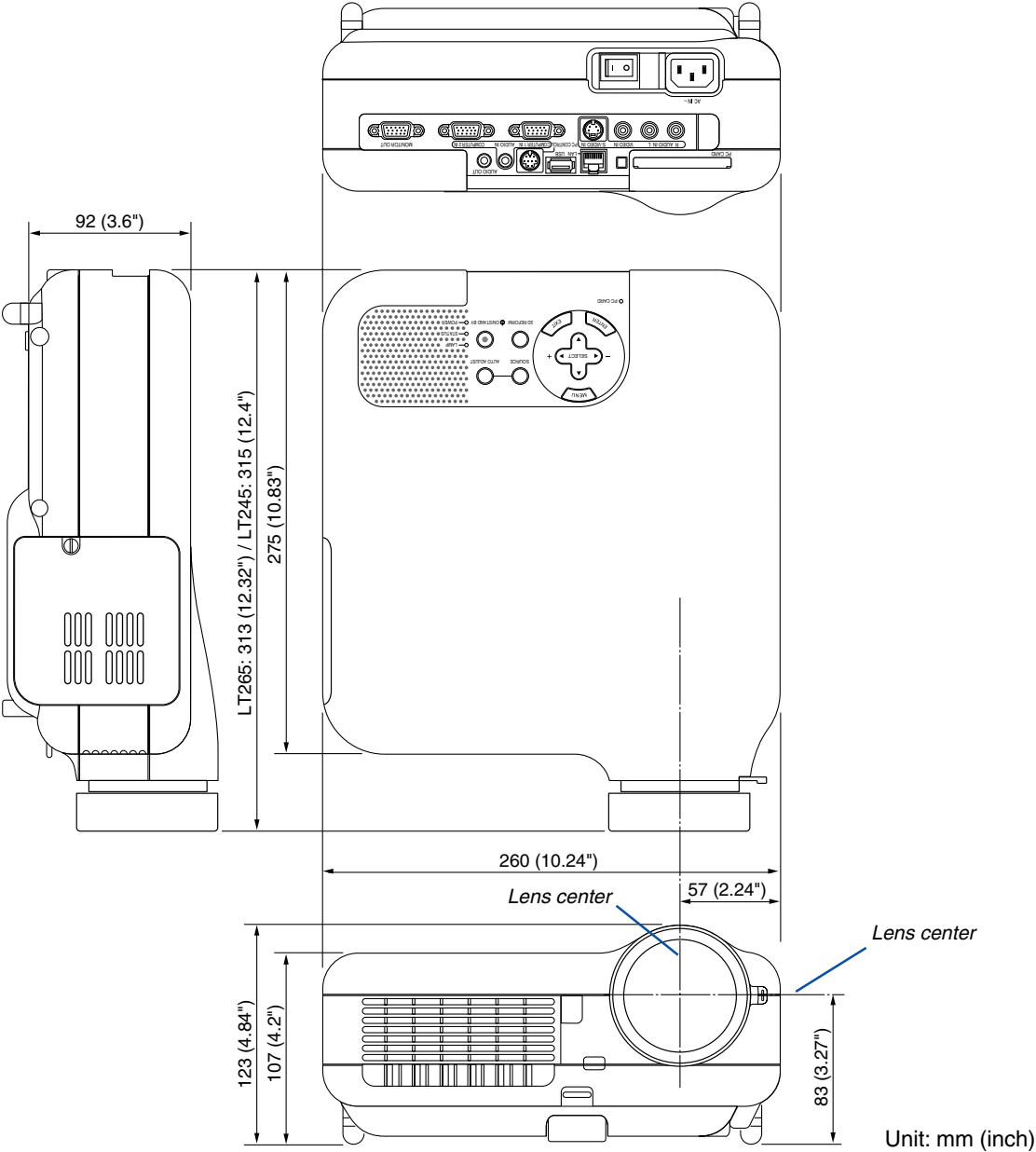

## ④ Pin Assignments of D-Sub COMPUTER 1/2 Input Connector

### Mini D-Sub 15 Pin Connector

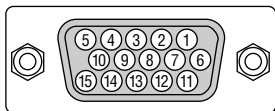

Signal Level

Video signal : 0.7Vp-p (Analog)

Sync signal : TTL level

\* COMPUTER 1 IN connector only

Pin No.	RGB Signal (Analog)	YCbCr Signal
1	Red	Cr
2	Green or Sync on Green	Y
3	Blue	Cb
4	Ground	
5	Ground	
6	Red Ground	Cr Ground
7	Green Ground	Y Ground
8	Blue Ground	Cb Ground
9	No Connection	
10	Sync Signal Ground	
11	Ground	
12	Bi-directional DATA (SDA)*	
13	Horizontal Sync or Composite Sync	
14	Vertical Sync	
15	Data Clock*	



## 5 Compatible Input Signal List

Signal	Resolution ( Dots )	Frequency H. ( kHz )	Refresh Rate ( Hz )	Dot Clock ( MHz )
NTSC	–	15.734	60	–
PAL	–	15.625	50	–
SECAM	–	15.625	50	–
VESA	640 × 480	31.47	59.94	25.175
IBM	640 × 480	31.47	60	25.175
MAC	640 × 480	31.47	60	25.175
MAC	640 × 480	34.97	66.67	31.334
MAC	640 × 480	35	66.67	30.24
VESA	640 × 480	37.86	72.81	31.5
VESA	640 × 480	37.5	75	31.5
IBM	640 × 480	39.375	75	31.49
VESA	640 × 480	43.269	85.01	36
IBM	720 × 350	31.469	70.09	28.322
VESA	720 × 400	37.927	85.04	35.5
IBM	720 × 350	39.44	87.85	35.5
IBM	720 × 400	39.44	87.85	35.5
VESA	800 × 600	35.16	56.25	36
VESA	800 × 600	37.879	60.32	40
VESA	800 × 600	48.077	72.19	50
VESA	800 × 600	46.88	75	49.5
VESA	800 × 600	53.674	85.06	56.25
MAC	832 × 624	49.725	74.55	57.283
VESA	1024 × 768	35.5	43 Interlaced	44.9
VESA	1024 × 768	48.363	60	65
VESA	1024 × 768	56.476	70.07	75
MAC	1024 × 768	60.241	74.93	80
VESA	1024 × 768	60.023	75.03	78.75
VESA	1024 × 768	68.677	85	94.5
# VESA	1152 × 864	67.5	75	108
# MAC	1152 × 870	68.681	75.06	100
# SUN	1152 × 900	61.796	65.95	92.94
# SGI	1152 × 900	71.736	76.05	105.6
# VESA	1280 × 960	60	60	108
# VESA	1280 × 1024	63.981	60.02	108
# MAC	1280 × 1024	69.89	65.2	118.5
# HP	1280 × 1024	78.125	72.01	135
# SUN	1280 × 1024	81.13	76.11	135
# VESA	1280 × 1024	79.976	75.03	135
# VESA	1280 × 1024	91.146	85.02	157.5
# HDTV (1080i)(1125i)	1920 × 1080	33.75	60 Interlace	74.25
# HDTV (1080i)(1125i)	1920 × 1080	28.13	50 Interlace	74.25
# HDTV (720p)(750p)	1280 × 720	45	60 Progressive	74.25
SDTV (480p)(525p)	–	31.47	59.94 Progressive	27
# VESA	1600 × 1200	75.0	60	162
# VESA	1600 × 1200	81.3	65	175.5
# VESA	1600 × 1200	87.5	70	189
# VESA	1600 × 1200	93.75	75	202.5
DVD YCbCr	–	15.734	59.94 Interlaced	–
DVD YCbCr	–	15.625	50 Interlaced	–

#:Images in above flagged with # are compressed with Advanced AccuBlend on LT265 and LT245.

*NOTE: Some composite sync signals may not be displayed correctly.*

*Signals other than those specified in the table above may not be displayed correctly. If this should happen, change the refresh rate or resolution on your PC. Refer to Display Properties help section of your PC for procedures.*

*UXGA (1600 × 1200) is supported for separate sync signal only.*

## ⑥ PC Control Codes and Cable Connection

### PC Control Codes

Function	Code Data											
POWER ON	02H	00H	00H	00H	00H	02H						
POWER OFF	02H	01H	00H	00H	00H	03H						
INPUT SELECT COMPUTER 1	02H	03H	00H	00H	02H	01H	01H	09H				
INPUT SELECT COMPUTER 2	02H	03H	00H	00H	02H	01H	02H	0AH				
INPUT SELECT VIDEO	02H	03H	00H	00H	02H	01H	06H	0EH				
INPUT SELECT S-VIDEO	02H	03H	00H	00H	02H	01H	0BH	13H				
INPUT SELECT VIEWER	02H	03H	00H	00H	02H	01H	1FH	27H				
PICTURE MUTE ON	02H	10H	00H	00H	00H	12H						
PICTURE MUTE OFF	02H	11H	00H	00H	00H	13H						
SOUND MUTE ON	02H	12H	00H	00H	00H	14H						
SOUND MUTE OFF	02H	13H	00H	00H	00H	15H						
ON SCREEN MUTE ON	02H	14H	00H	00H	00H	16H						
ON SCREEN MUTE OFF	02H	15H	00H	00H	00H	17H						
ASPECT RATIO (4:3 Screen)												
4:3	03H	10H	00H	00H	05H	18H	00H	00H	00H	00H	00H	30H
Letterbox	03H	10H	00H	00H	05H	18H	00H	00H	01H	00H	00H	31H
Widescreen	03H	10H	00H	00H	05H	18H	00H	00H	02H	00H	00H	32H
Crop	03H	10H	00H	00H	05H	18H	00H	00H	03H	00H	00H	33H
ASPECT RATIO (16:9 Screen)												
4:3 Window	03H	10H	00H	00H	05H	18H	00H	00H	00H	00H	00H	30H
Letterbox	03H	10H	00H	00H	05H	18H	00H	00H	01H	00H	00H	31H
Widescreen	03H	10H	00H	00H	05H	18H	00H	00H	02H	00H	00H	32H
4:3 Fill	03H	10H	00H	00H	05H	18H	00H	00H	04H	00H	00H	34H
AUTO ADJUST	02H	0FH	00H	00H	02H	05H	00H	18H				

*NOTE: Contact your local dealer for a full list of PC Control Codes if needed.*

### Cable Connection

#### Communication Protocol

Baud rate ..... 38400 bps  
 Data length ..... 8 bits  
 Parity ..... No parity  
 Stop bit ..... One bit  
 X on/off ..... None  
 Communications procedure ..... Full duplex

*NOTE: Depending on the equipment, a lower baud rate may be recommended for long cable runs.*

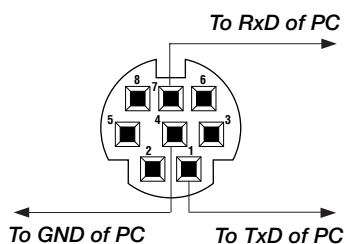
**PC Control Connector (DIN-8P)**

---

*NOTE 1: Pins 2, 3, 5, 6 and 8 are used inside the projector.*

---

*NOTE 2: For long cable runs it is recommended to set communication speed within projector menus to 9600 bps.*

---

**7 Using Software Keyboard**

1 to 0 and Characters

..... Use to type in password or keyword.

MODE ..... Selects one of three modes for alphabet and special characters.

SP ..... Inserts a space

BS ..... Deletes one character backward

◀ ..... Returns to the previous

▶ ..... Advances to the next

OK ..... Executes the selection

Cancel ..... Cancels the selection

---

*NOTE: You can drag the Software keyboard on the screen by clicking and holding any part on the keyboard except buttons.*

---

## 8 Troubleshooting Check List

Before contacting your dealer or service personnel, check the following list to be sure repairs are needed also by referring to the "Troubleshooting" section in your user's manual. This checklist below will help us solve your problem more efficiently.

\* Print the following pages.

**Frequency of occurrence**  always  sometimes (How often? \_\_\_\_\_)  other (\_\_\_\_\_)

### Power

- No power (POWER indicator does not light green) See also "Status Indicator (STATUS)".
  - Power cable's plug is fully inserted into the wall outlet.
  - Main power switch is pressed to the ON position.
  - Lamp cover is installed correctly .
  - Lamp Hour Meter (lamp operation hours) was cleared after lamp replacement.
  - No power even though you press and hold the POWER button for a minimum of 2 seconds.
- Shut down during operation.
  - Power cable's plug is fully inserted into the wall outlet.
  - Lamp cover is installed correctly .
  - Power Management is turned off (only models with the Power Management function).
  - Sleep Timer is turned off (only models with the Sleep Timer function ).

### Video and Audio

- No image is displayed from your PC or video equipment to the projector.
  - Still no image even though you connect the projector to the PC first, then start the PC.
  - Enabling your notebook PC's signal output to the projector.
    - *A combination of function keys will enable/disable the external display. Usually, the combination of the "Fn" key along with one of the 12 function keys turns the external display on or off.*
  - No image (blue background, logo, no display).
  - Still no image even though you press the AUTO ADJUST button.
  - Still no image even though you carry out "Reset" in the projector's menu.
  - Signal cable's plug is fully inserted into the input connector
  - A message appears on the screen. ( \_\_\_\_\_ )
  - The source connected to the projector is active and available.
  - Still no image even though you adjust the brightness and/or the contrast.
  - Input source's resolution and frequency are supported by the projector.
- Image is too dark.
  - Remains unchanged even though you adjust the brightness and/or the contrast.
- Image is distorted.
  - Image appears to be trapezoidal (unchanged even though you carry out the "Keystone" or "3D Reform" adjustment).
- Parts of the image are lost.
  - Still unchanged even though you press the AUTO ADJUST button.
  - Still unchanged even though you carry out "Reset" in the projector's menu.
- Image is shifted in the vertical or horizontal direction.
  - Horizontal and vertical positions are correctly adjusted on a computer signal.
  - Input source's resolution and frequency are supported by the projector.
  - Some pixels are lost.
- Image is flickering.
  - Still unchanged even though you press the AUTO ADJUST button.
  - Still unchanged even though you carry out "Reset" in the projector's menu.
  - Image shows flickering or color drift on a computer signal.
- Image appears blurry or out of focus.
  - Still unchanged even though you checked the signal's resolution on PC and changed it to projector's native resolution.
  - Still unchanged even though you adjusted the focus.
- No sound.
  - Audio cable is correctly connected to the audio input of the projector.
  - Still unchanged even though you adjusted the volume level.
  - AUDIO OUT is connected to your audio equipment (only models with the AUDIO OUT connector).

### Other

- Remote control does not work.
  - No obstacles between the sensor of the projector and the remote control.
  - Projector is placed near a fluorescent light that can disturb the infrared remote controls.
  - One or more remote sensors are enabled (only models with the Remote Sensor Selection function).
  - Batteries are new and are not reversed in installation.
  - If present on the remote control, projector selector switch is not used.
- Buttons on the projector cabinet do not work ( only models with the Key Lock function).
  - Cabinet Button Lock is not turned on or is disabled in the menu.
  - Still unchanged even though you press and hold the EXIT button for a minimum of 10 seconds.

In the space below please describe your problem in detail.

### Information on application and environment where your projector is used

#### Projector

Model number:

Serial No.:

Date of purchase:

Lamp operating time (hours):

Lamp Mode:  Normal  Eco

Information on input signal:

Horizontal synch frequency [     ] kHz

Vertical synch frequency [     ] Hz

Synch polarity H  (+)  (-)

V  (+)  (-)

Synch type  Separate  Composite

Sync on Green

STATUS Indicator:

Steady light  Orange  Green

Flashing light [     ] cycles

Remote control model number:

#### Installation environment

Screen size:                    inch

Screen type:  White matte  Beads  Polarization

Wide angle  High contrast

Throw distance:                feet/inch/m

Orientation:  Ceiling mount  Desktop

Power outlet connection:

Connected directly to wall outlet

Connected to power cord extender or other (the number of connected equipment \_\_\_\_\_)

Connected to a power cord reel or other (the number of connected equipment \_\_\_\_\_)

#### Computer

Manufacturer:

Model number:

Notebook PC  / Desktop

Native resolution:

Refresh rate:

Video adapter:

Other:

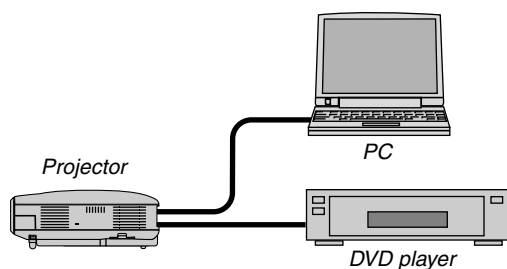

#### Signal cable

NEC standard or other manufacturer's cable?

Model number:                    Length:                    inch/m

Distribution amplifier

Model number:

Switcher

Model number:

Adapter

Model number:

#### Video equipment

VCR, DVD player, Video camera, Video game or other

Manufacturer:

Model number:

## 9 TravelCare Guide

### TravelCare - a service for international travelers

This product is eligible for "TravelCare", NEC's unique international warranty.

Please note that TravelCare coverage differs in part from coverage under the warranty included with the product.

### Services offered with TravelCare

This warranty allows customers to receive service on their product at the NEC and NEC-designated service stations in the countries listed herein when temporarily traveling internationally for business or pleasure.

For details on services offered by the different service stations, please refer to the "List of TravelCare Outlets" below.

#### 1 Repair services

The product will be repaired and delivered within 10 business days, not including shipping time.

During the term of warranty, the cost of maintenance parts, labor costs for repairs and shipping costs within the service station's coverage area are covered by the warranty.

#### 2 Replacement product rental service

If the customer desires, he or she can rent a replacement product while the original product is being repaired.

Fee: US\$200 for 12 days

This fee must be paid at the local service station in cash or credit card.

The \$200 rental fee is non-refundable even if the customer rents it less than 12 days before returning.

The replacement product will be delivered within 3 business days.

If the customer did not return the replacement product within 12 days, the customer will be charged the price of the unit.

If the customer returned the replacement product in a faulty or damaged condition, the repair cost will be charged to the customer.

Note that this service is not offered in all countries and regions. Please refer to the "List of TravelCare Outlets".

In addition, this replacement product rental service is not offered after the product's warranty has expired.

### Term of warranty

1

- a. Upon presentation of the warranty or receipt received upon purchase:

Valid for the term indicated on the warranty or the normal term of warranty for the country of purchase.

- b. When only the product is brought in:

Valid for a period of within 14 months of the date of manufacture indicated by the serial number attached to the product.

- 2 When a product whose term of warranty is expired is brought in:

Repairs will be offered for a fee. In this case the customer is not eligible for the replacement product rental service.

- 3 In the following cases, repairs may be charged, even if the product's warranty is still in effect:

- 1) If the term of warranty, model name, serial number and name of the store of purchase are not indicated on the warranty or have been altered.
- 2) Problems or damage caused by dropping or shocks during shipment or movement by the customer or by improper handling by the customers.
- 3) Problems or damage caused by improper usage or unwarrantable alterations or repairs by the customer.
- 4) Problems or damage caused by fire, salt damage, gas damage, earthquakes, lightning damage, storm or flood damage or other natural disasters or such external factors as dust, cigarette smoke, abnormal voltage, etc.

- 5) Problems or damage caused by use in hot or humid places, in vehicles, boats or ships, etc.
- 6) Problems or damage caused by expendable supplies or devices connected to the product other than those designated by NEC.
- 7) Problems caused by natural consumption, wear or deterioration of parts under normal usage conditions.
- 8) Problems or damage to lamps and other expendable supplies, included parts or optional parts.
- 9) Other conditions stipulated in the warranty included with the product also apply.

**NOTE:** The product can be used overseas with voltages of 100 to 120V and 200 to 240V by using a power cable suited for the standards and power source voltage of the country in which the product is being used.

### List of TravelCare Outlets

This list applies as of April 1, 2004.

For the most up-to-date information, please refer to the websites of the service stations in the various countries on the List of TravelCare Outlets or to the NEC website at <http://www.nec-pj.com>.

#### In Europe

NEC Europe, Ltd. / European Technical Centre

Address: Unit G, Stafford Park 12, Telford TF3 3BJ, U.K.  
 Telephone: +44 1952 237000  
 Fax Line: +44 1952 237006  
 Email Address: [AFR@uk.necur.com](mailto:AFR@uk.necur.com)  
 WEB Address: <http://www.necur.com>

(Regions Covered)

EU: Austria\*, Belgium\*, Denmark\*, Finland\*, France\*, Germany\*, Greece\*, Ireland\*, Italy\*, Luxembourg\*, The Netherlands\*, Portugal\*, Spain\*, Sweden\* and the United Kingdom\*

EEA: Norway\*, Iceland and Liechtenstein

#### In North America

NEC Solutions (America), Inc.

Address: 1250 N. Arlington Heights Road, Suite 400, Itasca, Illinois 60143, U.S.A.

Telephone: +1 800 836 0655  
 Fax Line: +1 800 356 2415  
 Email Address: [vsd.tech-support@necsam.com](mailto:vsd.tech-support@necsam.com)  
 WEB Address: <http://www.necvisualsystems.com>

(Regions Covered)

U.S.A. \*, Canada\*

#### In Oceania

NEC Australia Pty., Ltd.

Address: New South Wales;  
 184 Milperra Road, Reversby 2212  
 Victoria;  
 480 Princess Hwy Noble Park 3174  
 South Australia;  
 84A Richmond Road, Keswick 5035  
 Queensland;  
 116 Ipswich Road, Woollongabba 4102  
 Western Australia;  
 45 Sarich Court Osborne Park 6017  
 Telephone: 131 632 (from domestic)  
 +61 8 8375 5706 (from overseas)  
 Fax Line: +61 8 8375 5757  
 Email Address: [lee.gramola@nec.com.au](mailto:lee.gramola@nec.com.au)  
 WEB Address: <http://www.nec.com.au>

(Regions Covered)

Australia\*, New Zealand

### In Asia and Middle East

#### NEC Viewtechnology, Ltd.

Address: 686-1, Nishioi, Oi-Machi, Ashigarakami-Gun,  
Kanagawa 258-0017, Japan  
Telephone: +81 465 85 2369  
Fax Line: +81 465 85 2393  
Email Address: support\_pjweb@nevt.nec.co.jp  
WEB Address: <http://www.nec-pj.com>

(Regions Covered)  
Japan\*

#### NEC Hong Kong Ltd.

Address: 11th Floor, Tower B, New Mandarin Plaza, 14  
Science Museum Road,  
Tsim Sha Tsui East, Kowloon, Hong Kong  
Telephone: +852 2369 0335  
Fax Line: +852 2795 6618  
Email Address: esmond\_au@nechk.nec.com.hk  
WEB Address: <http://www.nec.com.hk>

(Regions Covered)  
Hong Kong

#### NEC Taiwan Ltd.

Address: 7F, No.167, SEC.2, Nan King East Road, Taipei,  
Taiwan, R.O.C.  
Telephone: +886 2 8500 1734  
Fax Line: +886 2 8500 1420  
Email Address: nickliao@nec.com.tw  
WEB Address: <http://www.nec.com.tw>

(Regions Covered)  
Taiwan

#### NEC Solutions Asia Pacific Pte. Ltd

Address: 401 Commonwealth Drive, #07-02, Haw Par  
Technocentre, Singapore 149598  
Telephone: +65 6 273 8333  
Fax Line: +65 6 274 2226  
Email Address: tehgh@rsc.ap.nec.com.sg  
WEB Address: <http://www.nec.com.sg/ap>

(Regions Covered)  
Singapore

#### NEC Systems Integration Malaysia Sdn Bhd

Address: Ground Floor, Menara TA One, 22, Jalan P. Ramlee,  
50250 Kuala Lumpur, Malaysia  
Telephone: +6 03 2164 1199  
Fax Line: +6 03 2160 3900  
Email Address: necare@nsm.nec.co.jp  
WEB Address: <http://www.necmalaysia.com.my>

(Regions Covered)  
Malaysia

#### Nautilus Hyosung Inc.

Address: 7th Floor, Cheongdam Building, 52,  
Cheongdam-Dong,  
Kangnam-Ku, Seoul, Korea 135-100  
Telephone: +82 2 510 0234  
Fax Line: +82 2 540 3584  
Email Address: hds-ykc@hyosung.com

(Regions Covered)  
South Korea

#### Lenso Communication Co., Ltd.

Address: 292 Lenso House 4, 1st Floor, Srinakarin Road,  
Huamark, Bangkok, Bangkok 10240, Thailand  
Telephone: +66 2 375 2425  
Fax Line: +66 2 375 2434  
Email Address: pattara@lenso.com  
WEB Address: <http://www.lenso.com>

(Regions Covered)  
Thailand

#### ABBA Electronics L.L.C.

Address: Tariq Bin Ziyad Road, P.O.Box 327, Dubai,  
United Arab Emirates  
Telephone: +971 4 371800  
Fax Line: +971 4 364283  
Email Address: ABBA@emirates.net.ae

(Regions Covered)  
United Arab Emirates

#### Samir Photographic Supplies

Address: P.O.Box 599, Jeddah 21421, Saudi Arabia  
Telephone: +966 2 6828219  
Fax Line: +966 2 6830820  
Email Address: vartkes@samir-photo.com

(Regions Covered)  
Saudi Arabia

**NOTE:** In countries designated with an asterisk(\*), replacement product rental service are offered.

Date: / / ,

P-1/ ,

**TO: NEC or NEC's Authorized Service Station:**

**FM:**

\_\_\_\_\_  
(Company & Name with signature)

Dear Sir (s),

I would like to apply your TravelCare Service Program based on attached registration and qualification sheet and agree with your following conditions, and also the Service fee will be charged to my credit card account, if I don't return the Loan units within the specified period. I also confirm following information is correct. Regards.

***Application Sheet for TravelCare Service Program***

Country, product purchased :	
User's Company Name :	
User's Company Address : Phone No., Fax No. :	
User's Name :	
User's Address :	
Phone No., Fax No. :	
Local Contact office :	
Local Contact office Address :	
Phone No., Fax No. :	
User's Model Name :	
Date of Purchase :	
Serial No. on cabinet :	
Problem of units per User :	
Required Service :	(1) Repair and Return      (2) Loan unit
Requested period of Loan unit :	
Payment method :	(1) Credit Card      (2) Travelers Cheque      (3) Cash
In Case of Credit Card : Card No. w/Valid Date :	



### Condition of your TravelCare Service Program

Enduser is requested to understand following condition of TravelCare Service Program and complete the necessary information on the application sheet.

#### 1. Service Options:

There are 3 types of "Service" available. Enduser has to understand following condition and is required to fill in the Application Sheet.

##### 1) Repair and Return:

The 'Faulty unit' is sent or collected from the customer. It is repaired and returned within 10 days to the customer, excluding transport time.

There may have a case, repair and return can't be done by NEC Authorized Service Station, because of shortage of spare parts due to same model is not sold in the territory.

##### 2) Repair and Return with Loan: (This service is limited to some Service Stations)

This service is offered to the Enduser, who cannot wait until their unit is repaired.

The customer can borrow a unit for \$200 up to 12 days. Customer then sends in inoperable unit to nearest NEC Authorized Service Station for service. In order to prevent collection problem, Enduser is required to fill in Application Sheet.

Enduser needs to confirm the availability of the Service to NEC Authorized Service Stations.

##### 3) Loan Only:

For this service, NEC Authorized Service Station supplies the customer with a loan unit for US\$200 up to 12 days. Customer keeps the inoperable unit and when customer returns home, customer arranges to have the projector serviced in the home country.

### 2. Warranty Exclusions:

This program does not apply if the Projector's serial number has been defaced, modified or removed.

If, in the judgement of NEC Authorized Service Station or its agent the defects or failures result from any cause other than fair wear and tear or NEC neglect, or fault including the following without limitation:

- 1) Accidents, transportation, neglect, misuse, abuse, water, dust, smoke or default of or by the Customer its employees or agents or any third party;
- 2) Failure or fluctuation of electrical power, electrical circuitry, air conditioning, humidity control or other environmental conditions such as use it in smoking area;
- 3) Any fault in the attachments or associated products or components (whether or not supplied by NEC or its agents which do not form part of the Product covered by this warranty);
- 4) Any act of God, fire, flood, war, act of violence or any similar occurrence;
- 5) Any attempt by any person other than any person authorized by NEC to adjust, modify, repair, install or service the product.
- 6) Any Cross-border charges such as, duty, insurance, tax etc.

### 3. Charges for Warranty Exclusions and Out of Warranty Case:

In case faulty unit is under warranty exclusions case or under Out of Warranty period, NEC Authorized Service Station will Inform estimation of actual service cost to the Enduser with reason.

### 4. Dead on Arrival (DOA):

Enduser must take this issue up with their original supplier in the country of purchase.

NEC Authorized Service Station will repair the DOA unit as a Warranty repair, but will not exchange DOA unit with new units.

### 5. Loan Service Charges and Conditions:

Upon acceptance of this NEC Projector, Customer agrees to assume liability for this loan unit.

The current cost of use of this loan unit is \$200.00 USD for 12 calendar days.

If Customer does not return the unit within the 12 calendar days, Customer will be charged the next highest cost up to and including the full list price to Credit Cards, which price will be informed by NEC Authorized Service Stations. Please see the attached listing of contacts for each country to arrange for pickup of the loan unit.

If you return to their country of origin with the loan unit, you will be charged additional freight to return the unit to the loaning country.

Thank you for your understanding of this program.

# LIMITED WARRANTY (USA and Canada only)

## NEC SOLUTIONS' PROJECTOR PRODUCTS

NEC Solutions (America), Inc. (hereafter NEC Solutions) warrants this product to be free from defects in material and workmanship under the following terms.

## HOW LONG IS THE WARRANTY

NEC Solutions' LT265 and LT245 projectors are covered by a two (2) year limited parts and labor warranty from the date of the first customer purchase. The lamp when used under normal operating conditions is warranted for 500 hours or 90 days, whichever comes first.

## WHO IS PROTECTED

This warranty may be enforced only by the first purchaser, and is not transferable.

## WHAT IS COVERED AND WHAT IS NOT COVERED

Except as specified below, this warranty covers all defects in material or workmanship in this product.

NEC SOLUTIONS' LIABILITY FOR ANY DEFECTIVE PRODUCT IS LIMITED TO THE REPAIR OR REPLACEMENT OF THE PRODUCT AT NEC SOLUTIONS' OPTION. REPLACEMENT PRODUCTS MAY BE NEW OR RECONDITIONED PRODUCTS, AND REPLACEMENT PARTS MAY BE NEW OR SERVICEABLE USED PARTS. The following are not covered by the limited warranty and NEC Solutions shall not be liable for:

1. Any product which is not distributed in the U.S.A. or Canada by NEC Solutions or which is not purchased, installed, and operated in the U.S.A or Canada.
2. Any product on which the serial number has been defaced, modified or removed.
3. Normal decrease in lamp light output over time.
4. Damage, deterioration or malfunction resulting from:
  - a. Accident, misuse, abuse, neglect, improper ventilation, fire, dust, smoke, water, lightning or other acts of nature, unauthorized product modification, or failure to follow instructions supplied with the product.
  - b. Repair or attempted repair by anyone other than a NEC Solutions authorized service center.
  - c. Any shipment of the product (claims must be presented to the carrier).
  - d. Removal or installation of the product.
  - e. Any other cause which does not relate to a product defect.
  - f. Use of the product beyond normal operating conditions. Normal operating conditions are defined as product use not in excess of 8 hours per day and 260 days per year.
5. Cartons, carrying cases, shipping cases, batteries, external cabinets, magnetic tapes, or any accessories used in connection with the product.
6. Service required as a result of third party components.

## WHAT NEC SOLUTIONS WILL PAY FOR

NEC Solutions will pay labor and material expenses for covered items, but NEC Solutions will not pay for the following:

1. Removal or installation charges.
2. Costs of technical adjustments, set-up, maintenance, or adjustment of user controls.
3. Payment of shipping and related charges incurred in returning the product for warranty repair.

## HOW YOU CAN GET WARRANTY SERVICE

1. To obtain service on your product, consult the dealer from whom you purchased the product.
2. Whenever warranty service is required, the original dated invoice (or a copy) must be presented as proof of warranty coverage. In order to obtain warranty service, you may be required to describe and demonstrate the problem to your dealer or to NEC Solutions.
3. All products returned to NEC Solutions for service MUST have prior approval. To receive approval or for the name of the nearest NEC Solutions authorized service center, call NEC Solutions at 800-836-0655.
4. It shall be your obligation and expense to ship the product, freight prepaid, or to deliver it to a NEC Solutions authorized service center, in either the original package or a similar package affording an equal degree of protection.
5. In the event a product is returned to NEC Solutions for warranty service, and it is determined that there is no product defect or that the product condition is not covered by this limited warranty, a diagnostic service fee may be charged to the customer.

## LIMITATION OF IMPLIED WARRANTIES

EXCEPT AS EXPRESSLY SET FORTH IN THIS LIMITED WARRANTY, NEC SOLUTIONS MAKES NO OTHER WARRANTIES, EXPRESS OR IMPLIED, INCLUDING BUT NOT LIMITED TO ANY IMPLIED WARRANTIES OR CONDITIONS OF MERCHANTABILITY AND FITNESS FOR A PARTICULAR PURPOSE. ANY IMPLIED WARRANTIES THAT MAY BE IMPOSED BY LAW ARE LIMITED TO THE TERMS AND DURATION OF THIS LIMITED WARRANTY.

## EXCLUSION OF DAMAGES

NEC SOLUTIONS' LIABILITY FOR ANY DEFECTIVE PRODUCT IS LIMITED TO THE REPAIR OR REPLACEMENT OF THE PRODUCT AT NEC SOLUTIONS' OPTION. NEC SOLUTIONS SHALL NOT BE LIABLE FOR:

1. DAMAGE TO OTHER PROPERTY CAUSED BY ANY DEFECTS IN THIS PRODUCT, DAMAGES BASED UPON INCONVENIENCE, LOSS OF USE OF THE PRODUCT, LOSS OF TIME, COMMERCIAL LOSS; OR
2. ANY OTHER DAMAGES, WHETHER INCIDENTAL, CONSEQUENTIAL OR OTHERWISE.

## HOW STATE LAW RELATES TO THE WARRANTY

SOME STATES DO NOT ALLOW LIMITATIONS ON HOW LONG AN IMPLIED WARRANTY LASTS AND/OR DO NOT ALLOW THE EXCLUSION OR LIMITATION OF INCIDENTAL OR CONSEQUENTIAL DAMAGES, SO THE ABOVE LIMITATIONS AND EXCLUSIONS MAY NOT APPLY TO YOU. THIS LIMITED WARRANTY GIVES YOU SPECIFIC LEGAL RIGHTS, AND YOU MAY HAVE OTHER RIGHTS WHICH VARY FROM STATE TO STATE.

## FOR MORE INFORMATION, CONTACT:

NEC SOLUTIONS (AMERICA), INC.  
1250 N. Arlington Heights Road  
Itasca, Illinois 60143-1248  
TELEPHONE 800-836-0655  
[www.necvisualsystems.com](http://www.necvisualsystems.com)

Customers are cautioned that product performance is affected by system configuration, software, the application, customer data, and operator control, among other factors. While NEC Solutions' products are considered to be compatible with many systems, the specific functional implementation by the customers of the product may vary. Therefore, the suitability of a product for a specific purpose or application must be determined by the customer and is not warranted by NEC Solutions.

---

---

# DECLARATION OF CONFORMITY

---

---

This device complies with Part 15 of FCC Rules. Operation is subject to the following two conditions. (1) This device may not cause harmful interference, and (2) this device must accept any interference received, including interference that may cause undesired operation.

<b>U.S. Responsible Party:</b>	<b>NEC Solutions (America), Inc.</b>
<b>Address:</b>	<b>1250 N. Arlington Heights Road Itasca, Illinois 60143</b>
<b>Tel. No.:</b>	<b>(630) 467-5000</b>

Type of Product:	Projector
Equipment Classification:	Class B Peripheral
Models:	LT265/LT245



*We hereby declare that the equipment specified above conforms to the technical standards as specified in the FCC Rules.*

---

---

# NEC LT265 GOV/LT245 GOV

## User's Manual Supplement

This document provides information exclusive to the LT265GOV/LT245GOV. For detailed product and usage information on the projector, read the supplied user documents: CD-ROM, Important Information and Quick Setup Guide.

### • Selecting Power-saving in Standby Mode

Select Advanced menu → Setup → Installation → Standby Mode

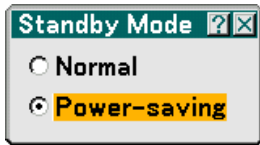

The projector has two standby modes: Normal and Power-saving.

Power-saving mode is the mode that allows you to put the projector in the power-saving condition which consumes less power than the Normal mode. The projector is preset for Normal mode at the factory.

---

#### **NOTE:**

- The MONITOR OUT function is not available during Power-saving mode.
  - Control through the PC Control connector and LAN mode is not available during Power-saving mode. For PC control and LAN mode of the projector it is recommended to leave the projector in the Normal mode.
  - Normal mode ..... Power indicator: Orange light/ Status indicator: Green light  
Power-saving mode ..... Power indicator: Orange light/Status indicator: Off  
See back page for a complete table of indicator messages.
- 

### • Power Consumption

Power consumption 12W in Normal mode; 0.7W in Power-saving mode

### • Setting Closed Caption

Select Basic menu or Advanced menu → Setup → Tools → Closed Caption

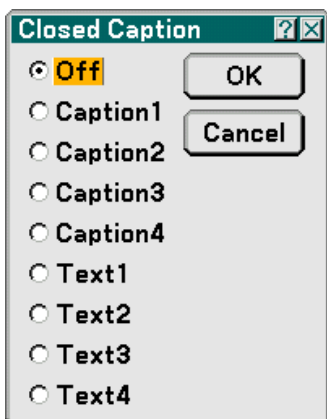

This option sets several closed caption modes that allows text to be superimposed on the projected image.

CAPTION 1-4 ..... Text is superimposed.

TEXT 1-4 ..... Text is displayed in full screen.

OFF ..... This exits the closed caption mode.

# Indicator Messages

## Power Indicator

Indicator Condition			Projector Condition	Note
Off			The main power is off	—
Blinking light	Green	0.5 sec On, 0.5 sec Off	The projector is getting ready to turn on.	Wait for a moment.
	Green	2.5 sec On, 0.5 sec Off	Off Timer is activated.	—
	Orange	0.5 sec On, 0.5 sec Off	The projector is cooling down.	Wait for a moment.
Steady light	Green		The projector is turned on.	—
	Orange		The projector is in Normal standby or Power-saving standby mode.	—

## Status Indicator

Indicator Condition			Projector Condition	Note
Off			Normal	—
Blinking light	Red	1 cycle (0.5 sec On, 2.5 sec Off)	Lamp cover error	Replace the lamp cover correctly.
		2 cycle (0.5 sec On, 0.5 sec Off)	Temperature error	The projector is overheated. Move the projector to a cooler location.
		3 cycle (0.5 sec On, 0.5 sec Off)	Power error	Power unit will not work correctly.
		4 cycle (0.5 sec On, 0.5 sec Off)	Fan error	Fans will not work correctly.
		6 cycle (0.5 sec On, 0.5 sec Off)	Lamp error	Lamp fails to light. Wait a full minute and then turn on again.
	Green		Re-firing the lamp	The projector is re-firing.
	Orange	1 cycle(0.5 sec On, 2.5 sec Off)	Network conflict	Network will not work correctly.
Steady light	Orange		Cabinet button is locked	You have pressed cabinet button when Cabinet Button is locked.
	Green		The projector is in Normal standby mode.	—

## Lamp Indicator

Indicator Condition			Projector Condition	Note
Off			Normal	—
Blinking light	Red		Lamp has reached its end of life. Lamp replacement message will be displayed.	Replace the lamp.
Steady light	Red		Lamp has been used beyond its limit. The projector will not turn on until the lamp is replaced.	Replace the lamp.
	Green		Lamp mode is set to Eco mode	—