

Panasonic
ideas for life

PT-DW7000U/U-K

DLP™-Based WXGA Projector

Native 16:9 Wide-Screen Impact



ProSelecta

View :: Compare :: Select - www.ProSelecta.com



3-Chip DLP™-Based System in a Sleek, Compact Body

The World's Lightest 3-Chip Large-Venue DLP™-Based Projector

The PT-DW7000U series combines the latest 3-chip system based on DLP™ technology with a new optical system developed using our exclusive technology. We have dramatically reduced the cabinet size, creating a unit with only one-fifth the volume of conventional large-venue 3-chip DLP™-based projectors. This feat of design and technology achieved the world's lightest* WXGA 3-chip projector with DLP™ technology. With a weight of 48.5 pounds (22.0 kg), the PT-DW7000U/U-K can go places other bulky 3-chip projectors with DLP™ technology have never gone before. * As of July 2004.



Superb Image Quality

Native 16:9 Panels

The PT-DW7000 is the world's first 3-chip DLP™ installation projector with 16:9 wide aspect panels. Unique to Panasonic, these panels let the PT-DW7000U/U-K project wide-screen images without sacrificing the superior image quality provided by DLP™ technology. They also fit more information onto a PC screen.

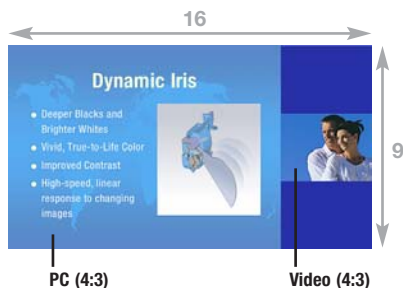

Picture in Picture images also fit more easily onto the screen.

Image Quality from 3-Chip DLP™ Technology

DLP™ technology delivers outstanding image resolution. In 3-chip systems with DLP™ technology—considered among the world's most advanced projector engines—a Digital Micromirror Device (DMD) chip is allocated to each of the red, green, and blue signals. This gives systems with DLP™ technology superior light utilization for high brightness, digital processing for low noise and linear white balance, extended device life for minimal image degradation, and a quick response that eliminates afterimages.

Powerful 6,000 Lumens

In addition to the 300-watt UHM™ lamp, the PT-DW7000U series incorporates digital and optical technologies that maximize the DLP™ technology advantages. They deliver 6,000 Lumens of brightness, offering superior color reproducibility.

Astounding 4,000:1 Contrast Ratio with Dynamic Iris

Panasonic's original Dynamic Iris achieves a dramatically improved contrast ratio of 4,000:1 in the PT-DW7000U series. Dynamic Iris constantly monitors the input signal, and adjusts the intensity of the light source to match it. This highly advanced function provides high-speed, linear response to changing images with 256-step precision. It also combines with dynamic gamma control to produce deep, rich blacks while preserving the brightness in the lighter portions of dark scenes.

16-Bit Color Depth for Film-Like Natural Image

Applying 16-bit drive to each of the RGB panels produces 8 times the level of expression (a total of 24 times for all three RGB panels) of conventional 13-bit drive devices. This system creates extremely smooth tonal expression with approx. 65,000 shades of gradation.

Progressive Cinema Scan (3/2 Pulldown)

This interlace/progressive conversion technology automatically detects when the input signal is derived from filmed material and selects the optimum progressive processing method to assure faithful reproduction of the original image. It is also compatible with the high-definition 1080i format.

Dynamic Sharpness Control

The Dynamic Sharpness Control circuit adjusts the video signal waveforms based on the difference in the brightness of adjacent pixels for a sharp, clear picture that is relatively unaffected by signal noise.

High Reliability and Easy Maintenance

Liquid-Cooling System

In systems with DLP™ technology, the microscopic mirrors of the DMD chip turn the light on and off. During the off period, light is directed away from the lens. Handling the heat from this light is a major point in maintaining the long-term performance of projectors with DLP™ technology. Panasonic's newly developed liquid-cooling system extends projector performance and attains a high level of reliability.

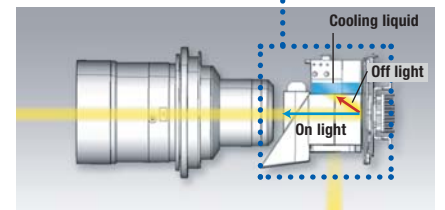

Dustproof Design with Sealed Optical Block

We have minimized the effect of dust by completely sealing the optical block. This dust-free design helps ensure that 3-chip projectors with DLP™ technology will continue to deliver crisp, sharp, high-resolution images over an extended service life.

Dual Lamp System and Lamp Relay Function

The use of two lamp systems increases brightness and eliminates the need to interrupt a presentation if a lamp burns out (in dual lamp operation mode). In single lamp operation mode, the lamp relay function greatly extends continuous operating time.

Optional Long-Life Lamp

A long-life lamp that stretches lamp life to 4,000 hours is available as an option. In single lamp operation mode, the lamp relay

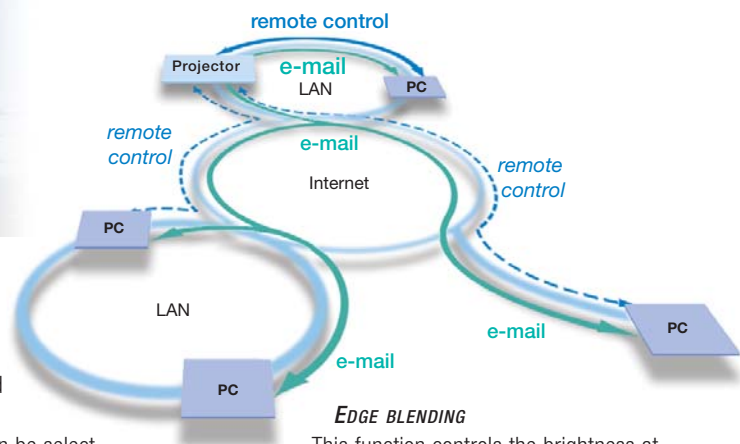

function allows non-stop operation 24 hours a day for up to 47 weeks without replacing the lamps. The use of UHM™ lamps dramatically cuts operating costs.

Easy Lamp Replacement

The PT-DW7000U series is designed to allow easy lamp replacement with the projector in its fully mounted condition. The lamp itself is the only part that needs to be replaced, which further increases overall reliability.

Dust Filter Cleaning

The dust filter is easy to clean, and you don't have to make any changes in the projector's mounting condition. This helps to minimize user down time.

Flexible System Applications

Horizontal/Vertical Lens Shift

The PT-DW7000U series is equipped with a motor-driven lens shifting function that moves the lens left, right, up, and down. It gives you easy, accurate adjustment when installing the projector.

Optical Lenses for Various Venues

A wide range of optional lenses with different throw distances are available in addition to the supplied lens. Optional lenses with super-long focal lengths of 8.0 to 15.0 are ideal for use in churches or screening rooms. These powered zoom/focus lenses enable the projectors to perform superbly in an array of projection environments, from classrooms to conference rooms. It's a snap to replace the "click-in" type lenses used in the bayonet system of the PT-DW7000U series.

Connection Terminals

The PT-DW7000U/U-K feature two RGB inputs, a composite video input and output, and an S-Video input. They also offer RS-232C/422 input and output, two remote inputs, and one remote output.



Connection terminals

An optional board module can be added for more connection flexibility.

Abundant Optional Interface Boards

In addition to the supplied connection terminals, an optional board module can be selected from a total of seven boards to match a variety of input source signals, including digital serial component signals.

Quiet Operation

The PT-DW7000U series is designed for quiet operation. A newly developed liquid-cooled optical system and noise-suppression duct and control system help minimize operating noise. The fan rotation can now be adjusted in finer steps, so fan noise is reduced when rotation adjusts to match room temperature changes. This helps minimize sudden increases in fan noise during operation.

Built-In Multi-Screen Processor, Color Matching and Edge Blending

MULTI-SCREEN PROCESSOR

The PT-DW7000U/U-K can project large, multi-screen images without any additional equipment. Up to 100 units (10 x 10) can be edge-blended at a time.

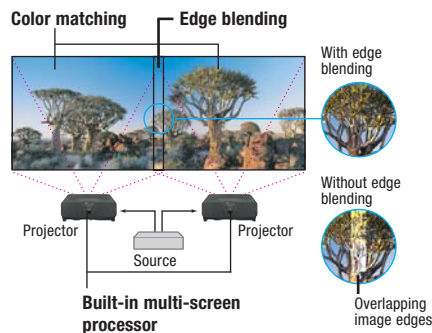

The built-in multi-screen processor enables enlarged multi-screen projection without using any additional special equipment. Color matching and edge blending make it easier to obtain proper multi-screen picture quality.

COLOR MATCHING

When several units are used together, this function corrects for slight variations in the color reproduction range of individual projectors. The PC software assures easy, accurate control. Independent, 7-axis adjustment (red, green, blue, yellow, magenta, cyan, white) ensures high precision and minimizes color variations. To simplify the set-up process, you can adjust the projectors before delivering them to the presentation site. The color-matching function accommodates up to nine units, for multi-screen or single screen presentation.

EDGE BLENDING

This function controls the brightness at overlapping image edges to assure uniform, natural-looking, multi-screen images. When projecting HD sources with a single projector, part of the DMD is unused. In multi-screen projections with two projectors, the DMDs increase the image's horizontal resolution while maximizing vertical resolution.

Networking (Optional)

Wired LAN System

The optional interface board ET-MD75NT for 10Base-T and 100Base-TX makes the PT-DW7000U series network-ready. Simply hook the projector up to an existing LAN network for easy remote control and/or monitoring. System administrators will appreciate this feature when using the PT-DW7000U/U-K as a fixed-installation projector.

Web Browser Control/Monitoring

Anybody can operate the PT-DW7000U series by remote control or monitor its status over a LAN network, because it is all done using the computer's familiar Web browser.

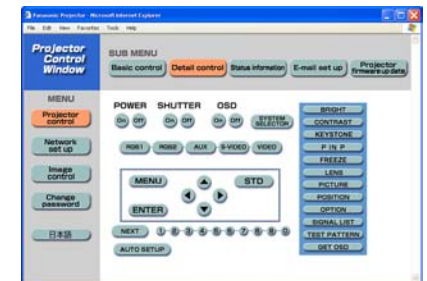

E-Mail Message Alert

The PT-DW7000U series automatically sends an e-mail message to notify the operator when an error has occurred, or a lamp needs to be replaced, providing an advanced level of maintenance ease and reliability.

More Valuable Features

- Mechanical shutter completely blocks light leakage when no image is being projected
- Momentary switching for RGB/Video input without disrupting the image
- 96 user memories

- Wireless/wired remote control unit with wireless mouse function*
- ID assignment for up to 64 units
- Coordinated group control for up to 26 groups (A-Z)
- Picture in picture (main/sub input source combinations possible only when using computer and video)
- Digital vertical keystone correction
- 3x digital zoom
- Built-in test pattern



Wireless/wired remote control

- Selectable 9-language on-screen menu (English, German, French, Spanish, Italian, Russian, Japanese, Chinese, Korean)

* Requires the optional ET-RMRC2 wireless mouse receiver



Available in black (PT-DW7000U-K) and white (PT-DW7000U) cabinet colors.

Ecology-Conscious Design

Panasonic works from every angle to minimize environmental impact in the product design, production and delivery processes, and in the performance of the product itself over its life cycle. The PT-DW7000U series reflects the following ecological considerations.

- Lead-free solder is used to mount components to the printed circuit boards.
- Lead-free glass is used for the lens.
- The packing case and operating manual are made from recycled paper.
- Lamp power switching further reduces power consumption.

Options for More Flexible Installation

Lenses



ET-D75LE1

- 1.5-2.0:1 zoom lens ET-D75LE1
- 2.0-3.0:1 zoom lens ET-D75LE2
- 3.0-5.0:1 zoom lens ET-D75LE3
- 5.0-8.0:1 zoom lens ET-D75LE4
- 8.0-15.0:1 zoom lens ET-D75LE8
- 0.8:1 fixed-focus short-throw lens ET-D75LE5

Boards



Network board ET-MD75NT

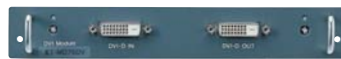

DVI board ET-MD75DV



SDI (480i/576i) input board ET-MD95SD1



SDI (480i/576i/480p) input board ET-MD95SD2



SDI (720p/1035i/1080i/1080-24p) input board ET-MD95SD3



Analog RGB input board ET-MD95RGB



Video/S-Video input board ET-MD95VM2

Lamps

Replacement lamp unit ET-LAD7500

Replacement lamp units (Twin pack of ET-LAD7500 lamp units) ET-LAD7500W

Replacement long-life lamp unit ET-LAD7700L

Replacement long-life lamp units (Twin pack of ET-LAD7700L lamp units) ET-LAD7700WL



Brackets

Ceiling mount bracket ET-PKD75

Low ceiling mount bracket ET-PKD75S

Dual stacking mount bracket ET-DFD75

Handle

Carrying handle ET-HAD75

Receiver

Wireless mouse receiver ET-RMRC2

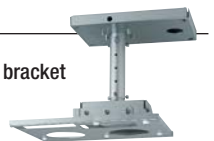

Projection Distance

PT-DW7000U/U-K

Diagonal image size (aspect ratio: 16:9)	Distance to screen											
	ET-D75LE1 1.5-2.0:1		ET-D75LE2 2.0-3.0:1		ET-D75LE3 3.0-5.0:1		ET-D75LE4 5.0-8.0:1		ET-D75LE8 8.0-15.0:1		ET-D75LE5 0.8:1	
	min.	max.	min.	max.	min.	max.	min.	max.	min.	max.	fixed	
1.8 m / 5.8' (70")	2.3 m / 7.6'	3.1 m / 10.1'	3.1 m / 10.3'	4.7 m / 15.5'	4.7 m / 15.5'	7.9 m / 26.0'	7.9 m / 26.0'	12.7 m / 41.7'	12.4 m / 40.7'	23.7 m / 77.8'	1.2 m / 3.8'	
2.5 m / 8.3' (100")	3.4 m / 11.0'	4.5 m / 14.8'	4.5 m / 14.8'	6.8 m / 22.3'	6.8 m / 22.3'	11.4 m / 37.4'	11.4 m / 37.4'	18.2 m / 59.7'	17.9 m / 58.7'	33.9 m / 111.2'	1.7 m / 5.5'	
5.1 m / 16.7' (200")	6.8 m / 22.2'	9.1 m / 29.7'	9.1 m / 29.7'	13.7 m / 44.9'	13.7 m / 44.9'	22.9 m / 75.1'	22.9 m / 75.1'	36.5 m / 119.8'	36.2 m / 118.8'	68.3 m / 224.1'	3.5 m / 11.3'	
7.6 m / 25.0' (300")	10.2 m / 33.5'	13.6 m / 44.7'	13.7 m / 45.0'	20.6 m / 67.5'	20.6 m / 67.5'	34.4 m / 112.9'	34.4 m / 112.9'	54.8 m / 179.9'	54.5 m / 178.8'	102.6 m / 336.6'	5.2 m / 17.1'	
10.2 m / 33.3' (400")	13.6 m / 44.7'	18.3 m / 60.0'	18.3 m / 60.0'	27.5 m / 90.1'	27.5 m / 90.1'	45.9 m / 150.7'	45.9 m / 150.7'	73.1 m / 239.9'	72.9 m / 239.2'	136.9 m / 449.1'	-	
15.2 m / 50.0' (600")	20.5 m / 67.1'	27.4 m / 89.8'	27.5 m / 90.2'	41.3 m / 135.3'	41.3 m / 135.3'	68.9 m / 226.2'	68.9 m / 226.2'	109.7 m / 360.0'	109.5 m / 359.3'	205.5 m / 674.2'	-	

Projection Range Example

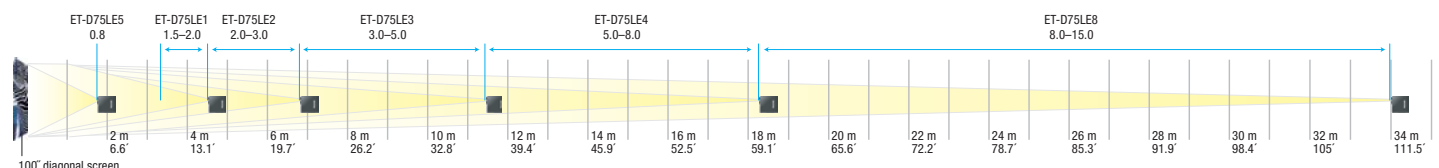

16:9 Wide Panels
4,000 : 1 Contrast Ratio

Bright, Vivid Images that Deliver All the Emotion and Excitement

Only a projector that offers superior brightness and contrast can give you vivid, faithful reproduction of images that have both light and dark areas, such as a starship in outer space or a face partly cloaked in shadow.

A projector like Panasonic's PT-DW7000U series.

The PT-DW7000U series combines outstanding 6,000-lumen brightness with 4,000:1 contrast*. Also featuring Texas Instruments Digital Light Processing™ (DLP™) technology and unique 16:9 wide-aspect panels (1,366 x 768), this 3-chip DLP™ projector truly excels in the projection of movie sources.

The PT-DW7000U series also adds features such as Dynamic Iris, which improves contrast by matching the lamp output to the input signal. The liquid-cooled optical engine boosts both reliability and durability while greatly reducing operating noise.

The PT-DW7000U series is suitable for a wide variety of applications, from boardrooms, conference rooms, post-production, and broadcasting to premium home theaters.

* With the Dynamic Iris set to 3.



Dynamic Iris: Deeper Blacks, Brighter Whites, and Vivid, True-to-Life Color

Incorporating Panasonic exclusive technology, the Dynamic Iris opens and closes with exceptional speed and precision as the input signal changes, resulting in accurate, real-time control of the light striking the DMD chips. The Dynamic Iris is positioned immediately after the light synthesizer and before the integrator, so it has minimal adverse effect on the overall light uniformity across the screen.



Competitor A

Blacks and other dark portions are washed out.



Competitor B

Thanks to functions such as lamp power switching, the blacks are not washed out. The white portions, however, become dim and dull.



Dynamic Iris and Dynamic Gamma

Dynamic Iris quickly fine-tunes the lamp output with 256-step precision. Dynamic Gamma preserves the brightness in bright portions, helping maintain a wide dynamic range.

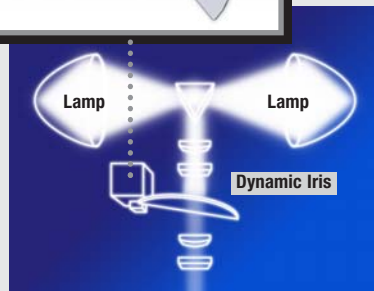
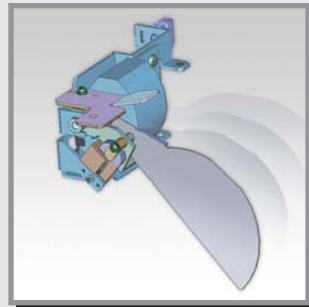

Specifications

System	DLP™ system
Device	0.85" (diagonal) DMD™ (x 3), 16:9
Pixels	1,049,088 (1,366 x 768) x 3
Lamp	300 W UHM™ lamp x 2 (BriteOptic™ Dual Lamp System)
Brightness	6000 lumens (dual lamp) 3000 lumens (single lamp)
Contrast ratio	4000:1 (full white/full black, with dynamic iris set to "3")
Resolution	
RGB	1366 x 768 pixels
Video	560 TV lines
Lens	Optional
Screen size	70"–600" diagonal
RGB input scanning frequency	f _H 15–100 kHz, f _V 24–120 Hz, Dot clock 20–162 MHz
Component signal	480i, 576i, 480p, 576p, 720/60p, 1035/60i, 1080/60i, 1080/50i, 1080/25p, 1080/24p, 1080/24sF, 1080/30p
Video signal	NTSC, PAL, SECAM, M-NTSC, PAL60, PAL-M, PAL-N
Terminals	
VIDEO IN	BNC
VIDEO OUT	BNC
S-Video IN	Mini DIN 4-pin
RGB1/Y/PbPr IN	BNC x 5
RGB2 IN	D-sub HD 15-pin
Optional board slot	x 1
RS-232C/422 IN	D-sub 9-pin female
RS-232C/422 OUT	D-sub 9-pin male
REMOTE 1 IN	M3 jack
REMOTE 1 OUT	M3 jack
REMOTE 2 IN	D-sub 9-pin female (parallel)
Optical axis shift*	Powered; horizontal ±30%, vertical ±65%
Keystone correction range	±40° (with ET-D75LE2)
Installation	Front/rear, ceiling/floor, (menu selection)
Power cord length	2.5 m (8.2')
Power supply	100–120 V AC, 60 Hz
Power consumption	800 W (800 VA) (12 W during standby mode with fan stopped)
Dimensions (W x H x D)	20-7/8" x 7-7/8" x 21-9/32" (530 x 200 x 540 mm) (without lens and lens hood)
Weight	48.5 lbs/22.0 kg (without lens)
Operating temperature	0°–40°C (32°–104°F) 0°–35°C (32°–95°F) (dual lamp, lamp power: high)
Operating humidity	10%–80% (no condensation)

Supplied accessories

- Wireless/wired remote control unit
- Batteries for remote control unit
- Remote control cable

* Shift range is limited during simultaneous horizontal and vertical shifting.

Optional accessories

- Replacement lamp unit (single): ET-LAD7700
- Replacement lamp unit (set of two lamps): ET-LAD7700W
- Replacement long-life lamp unit (single): ET-LAD7700L
- Replacement long-life lamp unit (set of two lamps): ET-LAD7700WL
- Ceiling mount bracket: ET-PKD75
- Low ceiling mount bracket: ET-PKD75S
- Dual stacking mount bracket: ET-DFD75
- Carrying handle: ET-HAD75
- Zoom lens (1.5–2.0:1): ET-D75LE1
- Zoom lens (2.0–3.0:1): ET-D75LE2
- Zoom lens (3.0–5.0:1): ET-D75LE3
- Zoom lens (5.0–8.0:1): ET-D75LE4
- Zoom lens (8.0–15.0:1): ET-D75LE8
- Fixed focus lens (0.8:1): ET-D75LE5
- DVI board: ET-MD75DV
- Network board: ET-MD75NT
- Video/S-Video input board: ET-MD95VM2
- SDI (480i/576i) input board: ET-MD95SD1
- SDI (480i/576i/480p) input board: ET-MD95SD2
- SDI (720p/1035i/1080i/1080-24p) input board: ET-MD95SD3
- RGB/Y/PbPr input board: ET-MD95RGB
- Wireless mouse receiver: ET-RMRC2

Lamp mode/brightness

No. of lamp	Lamp power	Brightness	
		Normal lamp	Long-life lamp
Dual	High	6,000 lm	–
	Low	4,800 lm	3,000 lm
Single	High	3,000 lm	–
	Low	2,400 lm	1,500 lm

Lamp mode/lamp life

Lamp mode	Lamp life	
	Normal lamp	Long-life lamp
High	1,500 hr	–
Low	2,000 hr	4,000 hr

- Using the long-life lamps, lamp life is 8,000 hours maximum when operated in single lamp mode with the lamp relay function on.
- Lamp life varies depending on usage conditions and the surrounding environment.
- When the long-life lamps are used the lamp power mode is automatically set to low.

Dimensions

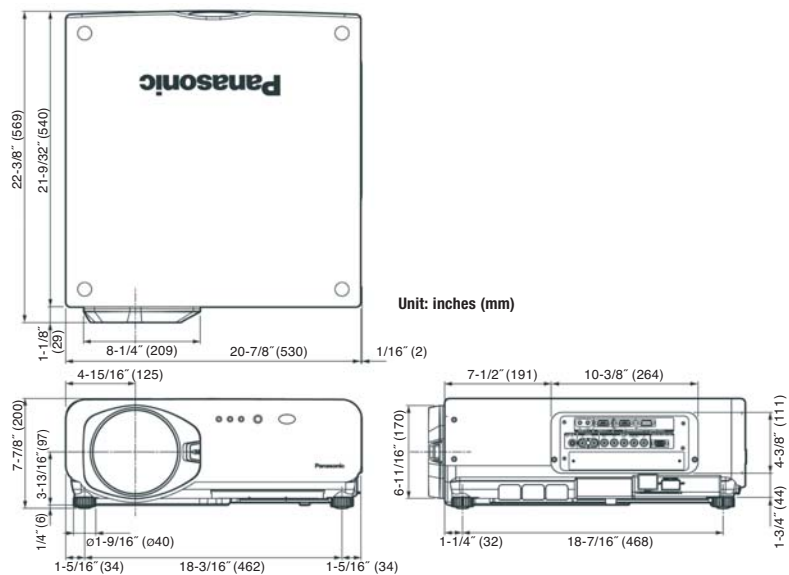

NOTES ON USE

- The projector uses a high-voltage mercury lamp that contains high internal pressure. This lamp may break, emitting a large sound, or fail to illuminate, due to impact or extended use. The length of time that it takes for the lamp to break or fail to illuminate varies greatly depending on individual lamp characteristics and usage conditions.
- The brightness of the lamp will gradually decrease with use.
- The replacement cycle of the lamp will be shortened if the power is frequently turned on and off or the projector is subjected to daily continuous use for 10 or more hours.

Panasonic®

Panasonic Broadcast & Television Systems Company
Presentation Systems Group
1 888 843 9788
www.panasonic.com/projectors

Headquarters
1 Panasonic Way, 4E-7
Secaucus, NJ 07094
201 348 5300
1 888 843 9788

Panasonic Canada Inc.
5770 Ambler Drive
Mississauga, Ontario
Canada L4W 2T3
905 624 5010

Please contact Panasonic or your dealer for a demonstration.



Weights and dimensions shown are approximate. Specifications are subject to change without notice. This product may be subject to export control regulations. UHM is a trademark of Matsushita Electric Industrial Co., Ltd. Digital Light Processing, DLP, DLP logo and the DLP medallion are trademarks of Texas Instruments. VGA and XGA are trademarks of International Business Machines Corporation. All other trademarks are the property of their respective trademark owners. Projection images simulated.

PT-DW7000U1-04SEP30K Printed in Japan.